

GASTRO-GROBKÜCHEN-GERÄTE

*** *gastronomisch gut* ***



Kühltechnik-Katalog 2019



Kurze Lieferzeiten



> 1.000.000 Produkte lagernd



Lieferung auch in 14 weitere Länder



Inhaltsverzeichnis

<h2>1</h2>	<ul style="list-style-type: none"> • Kühlschränke • Flaschenkühlschränke • Glas Kühlschränke • Barkühlschränke • Edelstahl-Kühlschränke • Fischkühlschränke • Bäckereikühlschränke • Weinkühlschränke • Saft- & Slush-Ice Maschinen 		<p>Seite 7 bis 34</p>	<h2>Kühlschränke</h2>
<h2>2</h2>	<ul style="list-style-type: none"> • Tiefkühlschränke • Edelstahl-Tiefkühlschränke • Bäckereitiefkühlschränke • Schockfroster 		<p>35 bis 44</p>	<h2>Tiefkühlschränke</h2>
<h2>3</h2>	<ul style="list-style-type: none"> • Serie 600 • Unterbaukühltische • Serie 700 • Mini-Kühltische 700 • Bäckereikühltische • Tiefkühltische • Schockfroster 		<p>45 bis 64</p>	<h2>Kühl- und Tiefkühltische</h2>
<h2>4</h2>	<ul style="list-style-type: none"> • Pizzakühltische • Pizzatische • Pizzakühlaufsätze • Saladetten • Vorbereitungskühltische • Sandwichtheken 		<p>65 bis 78</p>	<h2>Pizzakühltische & Saladetten</h2>
<h2>5</h2>	<ul style="list-style-type: none"> • Flaschen-Kühltruhen • Bierkühler • Ausschanktheken • Flaschenkühler • Flaschenkühltische • Fasskühler 		<p>79 bis 94</p>	<h2>Ausschank</h2>
<h2>6</h2>	<ul style="list-style-type: none"> • Aufsatzgetränk Kühler • Sushi- & Tapas-Theken • Kühl-Schauvitrienen • GastroLine • Gastro Buffet kalt & heiß 		<p>95 bis 112</p>	<h2>Kühlvitrienen</h2>
<h2>7</h2>	<ul style="list-style-type: none"> • Serie Sado • Serie Hill • Serie Geres • Serie Cordoba • Serie MAISTER Plus • Serie MAISTER 80 • Serie Rota • Serie Melody • Serie Regua • Serie Cake • Serie Tejo 		<p>113 bis 124</p>	<h2>Kühltheken</h2>
<h2>8</h2>	<ul style="list-style-type: none"> • Kühlregale • Wandkühlregale • Kühlregale Serie ITAL 60 & 80 		<p>125 bis 130</p>	<h2>Kühlregale</h2>
<h2>9</h2>	<ul style="list-style-type: none"> • Tiefkühltruhen • Speiseeisverkaufstruhen • Flaschen-Kühltruhen • Speiseeismaschinen • Eiswürfelbereiter • BREMA Eiswürfelbereiter 		<p>131 bis 150</p>	<h2>Rund ums Eis</h2>
<h2>10</h2>	<ul style="list-style-type: none"> • Lagerkühlzellen • Konfiskatkühler • Fasskühler • Kühlzellen 75 & 80 • Tiefkühlzellen 100 • Aggregate • Regalsysteme 		<p>151 bis 187</p>	<h2>Kühl- und Tiefkühlzellen, Regale</h2>









1

Kühlschränke

Kühlschränke	08 - 10
Flaschenkühlschränke	11 - 18
Glas Kühlschränke	13
Barkühlschränke	14 - 15
Edelstahl-Kühlschränke	19 - 23
Fischkühlschränke	20
Bäckereikühlschränke	24
Weinkühlschränke	25 - 30
Soft- & Slush-Ice Maschinen	32 - 33

Flaschen-Kühltruhen +1°C/+10°C

Zum Aufbewahren von Bierflaschen

	Artikel	Code	Euro
	<p>NEU</p> <p>Flaschen-Kühltruhe 133 Liter</p> <ul style="list-style-type: none"> · 573 x 573 x 904 mm · Innenmaß: 463 x 463 x 552 mm · Temperatur: +1°C/+10°C · Aluminiumrahmen · 4 Räder mit 2 Bremsen · mechanisches Thermostat  <p> °C L/net kg/net kg/br +1/+10 107 40 47 </p>	<p>KFT160</p>  <p>Kältemittel: R600a</p>	<p>479,00</p>
	<p>NEU</p> <p>Flaschen-Kühltruhe 208 Liter</p> <ul style="list-style-type: none"> · 763 x 653 x 904 mm · Innenmaß: 639 x 529 x 552 mm · Temperatur: +1°C/+10°C · Aluminiumrahmen · 4 Räder mit 2 Bremsen · mechanisches Thermostat  <p> °C L/net kg/net kg/br +1/+10 170 45 53 </p>	<p>KFT210</p>  <p>Kältemittel: R600a</p>	<p>579,00</p>
	<p>NEU</p> <p>Flaschen-Kühltruhe 314 Liter</p> <ul style="list-style-type: none"> · 1043 x 659 x 904 mm · Innenmaß: 915 x 529 x 552 mm · Temperatur: +1°C/+10°C · Aluminiumrahmen · 4 Räder mit 2 Bremsen · mechanisches Thermostat  <p> °C L/net kg/net kg/br +1/+10 258 55 62 </p>	<p>KFT310</p>  <p>Kältemittel: R600a</p>	<p>629,00</p>

Kühlschränke - Gastronomie

	Artikel	Code	Euro
<p>Neuer Türgriff!</p> 	<p>Kühlschrank 200 Liter, weiß</p> <ul style="list-style-type: none"> · 600 x 585 x 855 mm · Innenmaß: 510 x 485 x 620 mm · Temperatur: -2°C/+8°C · statische Kühlung mit Zwangsumwälzung · 100 W, 230 V, 50 Hz · Verbrauch: 1,12 kWh/24h · Umgebungstemperatur: 16°C bis 32°C · automatische Abtauung, Tür abschließbar · digitaler Temperaturregler, Türanschlag wechselbar · 2 Rollen hinten und 2 Füße vorne · inkl. 3 Roste: 2x 507 x 415 mm, 1x 507 x 225 mm · Verpackungsmaß: 680 x 650 x 1050 mm <p>mit Glastür</p> <ul style="list-style-type: none"> · LED-Beleuchtung · 105 W, 230 V, 50 Hz · Temperatur: +2°C/+8°C 	<p>UK200N</p> <p>499,00</p> <p>A</p> <p>Kältemittel: R600a</p>	
	<p>UKG200.01</p> <p>569,00</p> <p>Rost: 507-415</p> <p>36,00</p>		
	<p>Kühlschrank 350 Liter, weiß</p> <ul style="list-style-type: none"> · 600 x 585 x 1850 mm · Innenmaß: 510 x 485 x 1620 mm · Temperatur: -2°C/+8°C · statische Kühlung mit Zwangsumwälzung · 130 W, 230 V, 50 Hz · Verbrauch: 1,31 kWh/24h · Umgebungstemperatur: 16°C bis 32°C · automatische Abtauung, Tür abschließbar · digitaler Temperaturregler, Türanschlag wechselbar · 2 Rollen hinten und 2 Füße vorne · inkl. 4 Roste: 3x 507 x 415 mm, 1x 507 x 225 mm · Verpackungsmaß: 680 x 650 x 2100 mm <p>Glastür</p> <ul style="list-style-type: none"> · LED-Beleuchtung · 130 W, 230 V, 50 Hz · Temperatur: +2°C/+8°C 	<p>UK400N</p> <p>799,00</p> <p>C</p> <p>Kältemittel: R600a</p>	
	<p>UKG400.01</p> <p>869,00</p> <p>Rost: 507-415</p> <p>36,00</p>		
	<p>Kühlschrank 520 Liter, weiß</p> <ul style="list-style-type: none"> · 777 x 715 x 1720 mm · Innenmaß: 667 x 570 x 1485 mm, GN 2/1 · Temperatur: -2°C/+8°C · statische Kühlung mit Zwangsumwälzung · 130 W, 230 V, 50 Hz · Verbrauch: 1,71 kWh / 24h · Umgebungstemperatur: 16°C bis 32°C · automatische Abtauung, Tür abschließbar · digitaler Temperaturregler, Türanschlag wechselbar · 2 Rollen hinten und 2 Füße vorne · inkl. 3 Roste: 3x 652 x 530 mm · Verpackungsmaß: 840 x 760 x 2000 mm <p>mit Glastür</p> <ul style="list-style-type: none"> · LED-Beleuchtung · Temperatur: +2°C/+8°C 	<p>UK500N</p> <p>999,00</p> <p>C</p> <p>Kältemittel: R600a</p>	
	<p>UKG500.01</p> <p>1.119,00</p> <p>Rost: 652-530</p> <p>38,00</p>		

Kühlschränke - Gastronomie / Semi Profi

	Artikel	Code	Euro
	Kühlschrank 620 Liter, 1 Klapptür, weiß · 777 x 695 x 1895 mm · Innenmaß: 657 x 580 x 1660 mm · Temperatur: +0°C/+8°C · Umgebungstemperatur: 16°C bis 32°C · statische Kühlung mit Zwangsumwälzung · automatische Abtauung · 130 W, 230 V, 50 Hz, Verbrauch: 1,84 kW/24h · Türanschlag wechselbar · digitaler Temperaturregler · 2 Rollen hinten und 2 Füße vorne · inkl. 4 Roste: 3x 654 x 525 mm, 1x 654 x 330 mm · Verpackungsmaß: 840 x 760 x 2000 mm · Gewicht: 90 kg/109 kg	UK602N  	1.019,00
	mit Glastür · Temperatur: +2°C/+8°C, LED-Beleuchtung · 130 W, 230 V, 50 Hz, Gewicht: 104 kg/123 kg	UKG600.01 Rost: 654-525	1.119,00 37,00
	Kühlschrank 641 Liter, 1 Klapptür, weiß NEU · 777 x 730 x 1960 mm · Innenmaß: 663 x 581 x 1660 mm, GN 2/1 · Temperatur: +2°C/+8°C · Umgebungstemperatur: 16°C bis 32°C · Umluftkühlung · automatische Abtauung · 180 W, 230 V, 50 Hz, Verbrauch: 1,75 kW/24h · Tür abschließbar · Türanschlag wechselbar · digitaler Temperaturregler · auf 4 Rollen · inkl. 4 Roste: 3x 652 x 530 mm, 1x 664 x 330 mm · Verpackungsmaß: 840 x 760 x 2100 mm	UK702N  	1.339,00
	mit Glastür · LED-Beleuchtung	UKG700.01 Rost: 652-530	1.489,00 38,00
	Kühlschrank mit Glastür 170 Liter · 595 x 595 x 850 mm · Innenmaß: 515 x 450 x 660 mm · Temperatur: 0°C/+10°C · statische Kühlung · manuelle Abtauung mit Zwangsumwälzung · 190 W, 230 V, 50 Hz · 1 Klapptür mit Glaseinsatz · inkl. 3 verstellbare Böden (512 x 400 mm) · Verpackungsmaß: 690 x 650 x 910 mm	NLC-170.01 	549,00

Flaschenkühlschränke

	Artikel	Code	Euro
 1442 mm	Flaschenkühlschrank mit Glasür 230 Liter, weiß <ul style="list-style-type: none"> · 530 x 635 x 1442 mm · Innenmaß: 454 x 485 x 1214 mm · Temperatur: 0°C/+10°C · statische Kühlung mit Zwangsumwälzung · 180 W, 230 V, 50 Hz · Verbrauch: 2,0 kWh/24h · LED-Beleuchtung · Tür abschließbar · Türrahmen: grau · max. Umgebungstemperatur: +38°C · inkl. 4 Roste: 440 x 380 mm · Verpackungsmaß: 585 x 665 x 1501 mm 	LG-230 	599,00
	Türrahmen: schwarz	LG-230BB	599,00
		Rost: 440-380	28,00
 1562 mm	Flaschenkühlschrank mit Glasür 310 Liter, weiß <ul style="list-style-type: none"> · 620 x 635 x 1562 mm · Innen: 544 x 485 x 1334 mm · Temperatur: 0°C/+10°C · statische Kühlung mit Zwangsumwälzung · 245 W, 230 V, 50 Hz · Verbrauch: 2,4 kWh/24h · LED-Beleuchtung · Tür abschließbar · Türrahmen: grau · max. Umgebungstemperatur: +38°C · inkl. 4 Roste: 530 x 380 mm · Verpackungsmaß: 685 x 665 x 1621 mm 	LG-310 	689,00
	Türrahmen: schwarz	LG-310BB	689,00
		Rost: 530-380	28,00
 1732 mm	Flaschenkühlschrank mit Glasür 360 Liter, weiß <ul style="list-style-type: none"> · 620 x 635 x 1732 mm · Innenmaß: 544 x 485 x 1504 mm · Temperatur: 0°C/+10°C · statische Kühlung mit Zwangsumwälzung · 245 W, 230 V, 50 Hz · Verbrauch: 2,8 kWh/24h · LED-Beleuchtung · Tür abschließbar · Türrahmen: grau · max. Umgebungstemperatur: +38°C · inkl. 4 Roste: 530 x 380 mm · Verpackungsmaß: 685 x 665 x 1791 mm 	LG-360 	759,00
	Türrahmen: schwarz	LG-360BB	759,00
		Rost: 530-380	28,00









Flaschenkühlschränke

	Artikel	Code	Euro
 <div style="background-color: red; color: white; padding: 5px; font-weight: bold; font-size: 1.2em;">NEU</div>	<p>Flaschenkühlschrank 379 Liter, mit Glastür</p> <ul style="list-style-type: none"> · 595 x 605 x 1832 mm · Innenmaß: 505 x 425 x 1615 mm · Temperatur: +1°C / +10°C · 300 W, 230 V, 50 Hz · Kapazität: 330 ml, max. 406-476 Stück · LED-Beleuchtung · Tür abschließbar, Tür schließt automatisch · inkl. 5 Roste · Verpackungsmaß: 610 x 670 x 1985 mm 	<p>LBB-385</p> 	<p>629,00</p>
 <div style="background-color: red; color: white; padding: 5px; font-weight: bold; font-size: 1.2em;">NEU</div>	<p>Flaschenkühlschrank 379 Liter, mit 2 Glastüren</p> <ul style="list-style-type: none"> · 595 x 605 x 1832 mm · Innenmaß: 505 x 425 x 1615 mm · Temperatur: +1°C / +10°C · 280 W, 230 V, 50 Hz · Kapazität: 330 ml, max. 406-476 Stück · LED-Beleuchtung · Tür abschließbar, Tür schließt automatisch · inkl. 5 Roste · Verpackungsmaß: 610 x 670 x 1985 mm 	<p>LBB-385-2</p> 	<p>659,00</p>
 <div style="background-color: red; color: white; padding: 5px; font-weight: bold; font-size: 1.2em;">NEU</div>	<p>Flaschenkühlschrank 379 Liter, mit Glastür und Display</p> <ul style="list-style-type: none"> · 595 x 605 x 1994 mm · Innenmaß: 505 x 425 x 1615 mm · Temperatur: +1°C / +10°C · 300 W, 230 V, 50 Hz · Kapazität: 330 ml, max. 406-476 Stück · LED-Beleuchtung · Tür abschließbar, Tür schließt automatisch · inkl. 5 Roste · Verpackungsmaß: 610 x 670 x 2070 mm 	<p>BBD-385</p> 	<p>649,00</p>
 <div style="background-color: red; color: white; padding: 5px; font-weight: bold; font-size: 1.2em;">NEU</div>	<p>Flaschenkühlschrank 379 Liter, mit Glastür und Display</p> <ul style="list-style-type: none"> · 595 x 605 x 1994 mm · Innenmaß: 505 x 425 x 1615 mm · Temperatur: +1°C / +10°C · 280 W, 230 V, 50 Hz · Kapazität: 330 ml, max. 406-476 Stück · LED-Beleuchtung · Tür abschließbar, Tür schließt automatisch · inkl. 5 Roste · Verpackungsmaß: 610 x 670 x 2070 mm 	<p>BBD-385-2</p> 	<p>699,00</p>

Kühlschränke mit Glastür

	Artikel	Code	Euro
 <div style="position: absolute; top: 115px; left: 275px; background-color: red; color: white; padding: 5px; font-weight: bold; font-size: 24px;">NEU</div>	<p>Kühlschrank mit Glastür 360 Liter, 1 Klapptür, schwarz</p> <ul style="list-style-type: none"> · 620 x 635 x 1732 mm · Innenmaß: 544 x 485 x 1504 mm · Temperatur: 0°C/+10°C · statische Kühlung mit Zwangsumwälzung · max. Umgebungstemperatur: 38°C · 245 W, 230 V, 50 Hz · Verbrauch: 2,8 kWh · Türmaß 620 x 1570 mm · Tür abschließbar & LED-Beleuchtung · inkl. 4 höhenverstellbare Roste (530 x 380 mm) · Verpackungsmaß: 685 x 685 x 1791 mm 	<p>BB-360</p> <p> Kältemittel: R600a</p>	<p>739,00</p>
	<p>°C 0/+10 245 W 230 V / 50 Hz 2,8 kWh/24h kg/net 72 kg/br 79</p>	<p>Rost: 512-400-sw</p>	<p>31,00</p>
 <p style="text-align: center;">Klapptüren</p>	<p>Flaschenkühlschrank 490 Liter, 2 Glas-Klapptüren, schwarz</p> <ul style="list-style-type: none"> · 920 x 560 x 1872 mm · Innenmaß: 855 x 424 x 1437 mm · Temperatur: +2°C/+8°C, automatische Abtauung · statische Kühlung mit Zwangsumwälzung · 330 W, 230 V, 50 Hz, Verbrauch: 3,6 kW / 24h · Türschloss & LED-Beleuchtung · inkl. 8 höhenverstellbare Roste: 400 x 337 mm · Verpackungsmaß: 975 x 750 x 2030 mm 	<p>FS500.01</p> <p> Kältemittel: R600a</p>	<p>1.769,00</p>
	<p>°C +2/+8 230 V / 50 Hz 3,6 kWh/24h 330 W auto kg/net 120 kg/br 137</p>	<p>Rost: 400-337</p>	<p>38,00</p>
 <p style="text-align: center;">Schiebetüren</p>	<p>Flaschenkühlschrank 490 Liter, 2 Glas-Schiebetür, schwarz</p> <ul style="list-style-type: none"> · 920 x 560 x 1872 mm · Innenmaß: 855 x 424 x 1437 mm · Temperatur: +2°C/+8°C, automatische Abtauung · statische Kühlung mit Zwangsumwälzung · 330 W, 230 V, 50 Hz, Verbrauch: 3,6 kW / 24h · Türschloss & LED-Beleuchtung · inkl. 8 höhenverstellbare Roste: 400 x 337 mm · Verpackungsmaß: 975 x 750 x 2030 mm 	<p>FS500SD.01</p> <p> Kältemittel: 600a</p>	<p>1.829,00</p>
	<p>°C +2/+8 230 V / 50 Hz 3,6 kWh/24h 330 W auto kg/net 120 kg/br 137</p>	<p>Rost: 400-360L 400-360R</p>	<p>39,00 39,00</p>
 <div style="position: absolute; top: 755px; left: 275px; background-color: red; color: white; padding: 5px; font-weight: bold; font-size: 24px;">NEU</div>	<p>Flaschenkühlschrank 280 Liter, Glastür</p> <ul style="list-style-type: none"> · 450 x 700 x 1850 mm · Innenmaße: 370 x 567 x 1450 mm · Temperatur: 0°C/+10°C · Umluftkühlung, automatische Abtauung · 260 W, 230 V, 50 Hz · Verbrauch: 2,6 kWh/ 24h · selbstschließende Tür · LED-Beleuchtung · digitales Thermostat · inkl. 5 verstellbare Roste, Rollen · Verpackungsmaß: 500 x 700 x 1880 mm 	<p>LSC-320</p> <p> Kältemittel: 600a</p>	<p>799,00</p>
	<p>°C 0/+10 260 W 230 V / 50 Hz 2,6 kWh/24h auto kg/net 75,5 kg/br 81</p>		

Flaschenkühlschränke - Edelstahl

	Artikel	Code	Euro
 <p>EDELSTAHL</p>	<p>Flaschenkühlschrank 138 Liter, Edelstahl, 1 Klapptür</p> <ul style="list-style-type: none"> · 600 x 520 x 900 mm · Innenmaß: 520 x 420 x 750 mm · Temperatur: 0°C/+10°C · 180 W, 230 V, 50 Hz · Verbrauch: 1,5 kWh/24h · mit automatischer Türschließung, inkl. Türschloß · inkl. 2 höhenverstellbare Roste: 500 x 346 mm · Verpackungsmaß: 650 x 570 x 980 mm 	<p>LG-138ES</p> <p></p>	<p>789,00</p>
<p>°C 0/+10 ⚡ 180 W ⚡ 230 V / 50 Hz 📊 1,5 kWh ❄️ auto 📦 /net 48 📦 /br 58</p>			
		<p>Rost: 500-346</p>	<p>33,00</p>
 <p>EDELSTAHL</p>	<p>Flaschenkühlschrank 208 Liter, Edelstahl, 2 Klapptüren</p> <ul style="list-style-type: none"> · 900 x 520 x 900 mm · Innenmaß: 820 x 420 x 750 mm · Temperatur: 0°C/+10°C · 230 W, 230 V, 50 Hz · Verbrauch: 1,9 kWh/24h · mit automatischer Türschließung, inkl. Türschloß · inkl. 4 höhenverstellbare Roste: 400 x 346 mm · Verpackungsmaß: 960 x 570 x 980 mm 	<p>LG-208ES</p> <p></p>	<p>959,00</p>
<p>°C 0/+10 ⚡ 230 W ⚡ 230 V / 50 Hz 📊 1,9 kWh ❄️ auto 📦 /net 62 📦 /br 72</p>			
		<p>Rost: 400-346L 400-346R</p>	<p>27,00 28,00</p>
 <p>EDELSTAHL</p>	<p>Flaschenkühlschrank 330 Liter, Edelstahl, 3 Klapptüren</p> <ul style="list-style-type: none"> · 1350 x 520 x 900 mm · Innenmaß: 1270 x 420 x 750 mm · Temperatur: 0°C/+10°C · 300 W, 230 V, 50 Hz · Verbrauch: 2,5 kWh/24h · mit automatischer Türschließung, inkl. Türschloß · inkl. 6 höhenverstellbare Roste: 2x 440 x 346 mm (mitte) 4x 400 x 346 mm (links/rechts) · Verpackungsmaß: 1405 x 570 x 980 mm 	<p>LG-330ES</p> <p></p>	<p>1.319,00</p>
<p>°C 0/+10 ⚡ 300 W ⚡ 230 V / 50 Hz 📊 2,5 kWh ❄️ auto 📦 /net 80 📦 /br 90</p>			
		<p>Rost: 440-346LR 440-346M</p>	<p>27,00 28,00</p>
 <p>EDELSTAHL inkl. Rollen</p>	<p>Party-Kühler Edelstahl 50 Liter, für 21 Flaschen</p> <p>NEU</p> <ul style="list-style-type: none"> · Ø 503 x 838 mm · Maße mit ausgeklappten Ablagen: 918 x 503 x 838 mm · Temperatur: +4°C/+15°C · 60 W, 230 V, 50 Hz · Lautstärke: 46 dB · 2 verstell- und klappbare Ablagen in schwarz inkl. Hängkörbe für Flaschen · temperierte Glasoberfläche · Steuerelement mit digitalem Display · inklusive Rollen · Verpackungsmaß: 550 x 550 x 880 mm 	<p>PAT-50SS</p> <p></p>	<p>429,00</p>
<p>°C +4/+15 L 50 📦 21 ⚡ 60 W ⚡ 230 V / 50 Hz 📦 /net 22,5 📦 /br 25,8</p>			





Flaschenkühlschränke

Allgemeine Beschreibung

- Temperatur: 0°C/+10°C
- max. Außentemperatur: 38°C
- Glastür
- LED-Beleuchtung
- Umluftkühlung

- digitale Temperaturregelung mit LED Anzeige
- automatische Abtauung
- Tür schließt automatisch
- Tür ist abschließbar

- Frontglasbelüftung
- Umgebungstemp bis +32°C
- keine Führungsschienen
- Roste werden mit Klips befestigt
- Türanschlag NICHT wechselbar

	Artikel	Code	Euro														
	Flaschenkühlschrank 138 Liter, 1 Klapptür schwarz <ul style="list-style-type: none"> · 600 x 520 x 900 mm · Innenmaß: 520 x 385 x 750 mm · 180 W, 230 V, 50 Hz · Verbrauch: 1,5 kWh/24h · 2 Roste: 500 x 346 mm · Verpackungsmaß: 650 x 570 x 980 mm 	LG-138  LG-138SS	529,00 529,00														
	silber	LG-138SS	529,00														
<table border="0" style="width:100%; text-align:center;"> <tr> <td>°C</td> <td>⚡</td> <td>230 V / 50 Hz</td> <td>24h</td> <td>auto</td> <td>kg/net</td> <td>kg/br</td> </tr> <tr> <td>0/+10</td> <td>180 W</td> <td>230 V / 50 Hz</td> <td>1,5 kWh</td> <td></td> <td>48</td> <td>58</td> </tr> </table>				°C	⚡	230 V / 50 Hz	24h	auto	kg/net	kg/br	0/+10	180 W	230 V / 50 Hz	1,5 kWh		48	58
°C	⚡	230 V / 50 Hz	24h	auto	kg/net	kg/br											
0/+10	180 W	230 V / 50 Hz	1,5 kWh		48	58											
	Flaschenkühlschrank 208 Liter 2 Klapptüren - schwarz <ul style="list-style-type: none"> · 900 x 520 x 900 mm · Innenmaß: 820 x 366 x 750 mm · 230 W, 230 V, 50 Hz · Verbrauch: 1,9 kWh/24h · 4 Roste: 400 x 346 mm · Verpackungsmaß: 960 x 570 x 980 mm 	LG-208H  LG-208S	729,00 729,00														
	2 Schiebetüren - silber	LG-208S	729,00														
<table border="0" style="width:100%; text-align:center;"> <tr> <td>°C</td> <td>⚡</td> <td>230 V / 50 Hz</td> <td>24h</td> <td>auto</td> <td>kg/net</td> <td>kg/br</td> </tr> <tr> <td>0/+10</td> <td>230 W</td> <td>230 V / 50 Hz</td> <td>1,9 kWh</td> <td></td> <td>62</td> <td>72</td> </tr> </table>				°C	⚡	230 V / 50 Hz	24h	auto	kg/net	kg/br	0/+10	230 W	230 V / 50 Hz	1,9 kWh		62	72
°C	⚡	230 V / 50 Hz	24h	auto	kg/net	kg/br											
0/+10	230 W	230 V / 50 Hz	1,9 kWh		62	72											
	Flaschenkühlschrank 330 Liter, 3 Klapptüren schwarz <ul style="list-style-type: none"> · 1350 x 520 x 900 mm · Innenmaß: 1270 x 366 x 750 mm · 300 W, 230 V, 50 Hz · Verbrauch: 2,5 kWh/24h · 6 Roste: 440 x 346 mm · Verpackungsmaß: 1405 x 570 x 980 mm 	LG-330H  LG-330S	914,00 914,00														
	3 Schiebetüren - silber	LG-330S	914,00														
<table border="0" style="width:100%; text-align:center;"> <tr> <td>°C</td> <td>⚡</td> <td>230 V / 50 Hz</td> <td>24h</td> <td>auto</td> <td>kg/net</td> <td>kg/br</td> </tr> <tr> <td>0/+10</td> <td>300 W</td> <td>230 V / 50 Hz</td> <td>2,5 kWh</td> <td></td> <td>80</td> <td>90</td> </tr> </table>				°C	⚡	230 V / 50 Hz	24h	auto	kg/net	kg/br	0/+10	300 W	230 V / 50 Hz	2,5 kWh		80	90
°C	⚡	230 V / 50 Hz	24h	auto	kg/net	kg/br											
0/+10	300 W	230 V / 50 Hz	2,5 kWh		80	90											
	Flaschenkühlschrank 330 Liter, 3 Schiebetüren silber <ul style="list-style-type: none"> · 1350 x 520 x 900 mm · Innenmaß: 1270 x 366 x 750 mm · 300 W, 230 V, 50 Hz · Verbrauch: 2,5 kWh/24h · 6 Roste: 440 x 346 mm · Verpackungsmaß: 1405 x 570 x 980 mm 	LG-330H  LG-330S	919,00 919,00														
	3 Schiebetüren - schwarz	LG-330S	919,00														
<table border="0" style="width:100%; text-align:center;"> <tr> <td>°C</td> <td>⚡</td> <td>230 V / 50 Hz</td> <td>24h</td> <td>auto</td> <td>kg/net</td> <td>kg/br</td> </tr> <tr> <td>0/+10</td> <td>300 W</td> <td>230 V / 50 Hz</td> <td>2,5 kWh</td> <td></td> <td>80</td> <td>90</td> </tr> </table>				°C	⚡	230 V / 50 Hz	24h	auto	kg/net	kg/br	0/+10	300 W	230 V / 50 Hz	2,5 kWh		80	90
°C	⚡	230 V / 50 Hz	24h	auto	kg/net	kg/br											
0/+10	300 W	230 V / 50 Hz	2,5 kWh		80	90											
Rost: 500-346			33,00														
Rost: 400-346L 400-346R			27,00 28,00														
Rost: 440-346LR 440-346M			27,00 28,00														
Rost: 440-346LR 440-346M			27,00 28,00														









Flaschenkühlschränke

	Artikel	Code	Euro
	Flaschenkühlschrank 300 Liter, 1 Klapptür <ul style="list-style-type: none"> · 620 x 595 x 1800 mm · Innenmaß: 530 x 433 x 1225 mm · Temperatur: 0°C/+10°C · Umluftkühlung, automatische Abtauung · 185 W, 230 V, 50 Hz · Verbrauch: 1,74 kW/24h · LED-Beleuchtung · digitales Thermostat · Tür abschließbar · inkl. 4 Roste: 502 x 380 mm · Verpackungsmaß: 685 x 665 x 1880 mm 	LG-300F  	679,00 Rost: 502-380 25,00
	Flaschenkühlschrank 350 Liter, 1 Klapptür <ul style="list-style-type: none"> · 620 x 635 x 1890 mm · Innenmaß: 530 x 473 x 1315 mm · Temperatur: 0°C/+10°C · Umluftkühlung, automatische Abtauung · 205 W, 230 V, 50 Hz · Verbrauch: 1,84 kW/24h · LED-Beleuchtung · digitales Thermostat · Tür abschließbar · inkl. 4 Roste: 502 x 420 mm · Verpackungsmaß: 685 x 665 x 2070 mm 	LG-350F  	739,00 Rost: 502-420 26,00
	Flaschenkühlschrank 430 Liter, 1 Klapptür <ul style="list-style-type: none"> · 620 x 690 x 2073 mm · Innenmaß: 530 x 545 x 1495 mm · Temperatur: 0°C/+10°C · Umluftkühlung, automatische Abtauung · 250 W, 230 V, 50 Hz · Verbrauch: 2,3 kW/24h · LED-Beleuchtung · Tür abschließbar · inkl. 4 Roste: 502 x 480 mm · Verpackungsmaß: 955 x 770 x 2136 mm 	LG-430F  	849,00 Rost: 502-480 27,00
	Flaschenkühlschrank 660 Liter, 1 Klapptür <ul style="list-style-type: none"> · 840 x 730 x 2036 mm · Innenmaß: 750 x 595 x 1535 mm · Temperatur: 0°C/+10°C · Umluftkühlung, automatische Abtauung · 400 W, 230 V, 50 Hz · Verbrauch: 3,0 kW/24h · LED-Beleuchtung · Tür abschließbar, 4 Rollen · inkl. 4 Roste: 725 x 505 mm · Verpackungsmaß: 895 x 785 x 2236 mm 	LG-660  	1.269,00 Rost: 725-505 36,00

Flaschenkühlschränke - Doppelt

	Artikel	Code	Euro
	Flaschenkühlschrank 400 Liter, 2 Klapptüren · 900 x 630 x 1856 mm · Innenmaß: 800 x 500 x 1085 mm · Temperatur: 0°C/+10°C · Umluftkühlung, automatische Abtauung · 350 W, 230 V, 50 Hz, Verbrauch: 2,6 kW/24h · inkl. 8 Roste: 405 x 390 mm · Verpackungsmaß: 955 x 675 x 1956 mm	LG-400  Rost: 405-390L 405-390R	1.199,00 32,00 32,00
	Flaschenkühlschrank 600 Liter, 2 Klapptüren · 900 x 725 x 2036 mm · Innenmaß: 810 x 595 x 1275 mm · Temperatur: 0°C/+10°C · Umluftkühlung, automatische Abtauung · 450 W, 230 V, 50 Hz, Verbrauch: 3,0 kW/24h · inkl. 8 Roste: 500 x 390 mm · Verpackungsmaß: 955 x 770 x 2136 mm	LG-600  Rost: 500-390L 500-390R	1.289,00 32,00 32,00
	Flaschenkühlschrank 800 Liter, 2 Klapptüren · 1000 x 730 x 2036 mm · Innenmaß: 910 x 595 x 1535 mm · Temperatur: 0°C/+10°C · Umluftkühlung, automatische Abtauung · 550 W, 230 V, 50 Hz, Verbrauch: 3,4 kW/24h · inkl. 8 Roste: 440 x 500 mm · Verpackungsmaß: 1060 x 785 x 2236 mm	LG-800  Rost: 440-500L 440-500R	1.519,00 32,00 32,00
	Flaschenkühlschrank 800 Liter, 2 Schiebetüren	 · 1000 x 730 x 2036 mm · Innenmaß: 910 x 595 x 1535 mm · Temperatur: 0°C/+10°C · Umluftkühlung, automatische Abtauung · 550 W, 230 V, 50 Hz, Verbrauch: 3,4 kW/24h · inkl. 8 Roste: 440 x 500 mm · Verpackungsmaß: 1060 x 785 x 2236 mm	LG-800ST  Rost: 530-480L 530-480R
	Flaschenkühlschrank 1000 Liter, 2 Schiebetüren · 1200 x 730 x 2036 mm · Innenmaß: 910 x 595 x 1535 mm · Temperatur: 0°C/+10°C · Umluftkühlung, automatische Abtauung · 550 W, 230 V, 50 Hz, Verbrauch: 3,4 kW/24h · inkl. 8 Roste: 440 x 500 mm · Verpackungsmaß: 1060 x 785 x 2236 mm	LG-1000S  Rost: 440-500L 440-500R	1.739,00 32,00 32,00

Getränkekühlschränke

	Artikel	Code	Euro
 <div style="position: absolute; top: 10px; right: 10px; background-color: red; color: white; padding: 5px; font-weight: bold; font-size: 1.2em;">NEU</div>	Getränkekühler 514 Liter <ul style="list-style-type: none"> · 640 x 718 x 2145 mm · Innenmaß: 550 x 590 x 1480 mm · Temperatur: +1°C/+10°C · Kapazität max. 616 330 ml-Dosen · inkl. 5 Roste · Verpackungsmaße: 655 x 735 x 2230 mm 	GK-510 	1.059,00
 <div style="position: absolute; top: 10px; right: 10px; background-color: red; color: white; padding: 5px; font-weight: bold; font-size: 1.2em;">NEU</div>	Getränkekühler 640 Liter <ul style="list-style-type: none"> · 775 x 718 x 2145 mm · Innenmaß: 685 x 590 x 1480 mm · Temperatur: +1°C/+10°C · Kapazität max. 770 330 ml-Dosen · inkl. 5 Roste · Verpackungsmaße: 790 x 735 x 2230 mm 	GK-710 	1.099,00
 <div style="position: absolute; top: 10px; right: 10px; background-color: red; color: white; padding: 5px; font-weight: bold; font-size: 1.2em;">NEU</div>	Getränkekühler 832 Liter, 2 Schiebetüren <ul style="list-style-type: none"> · 980 x 718 x 2145 mm · Innenmaß: 890 x 590 x 1480 mm · Temperatur: +1°C/+10°C · Kapazität max. 1001 330 ml-Dosen · inkl. 5 Roste · Verpackungsmaße: 995 x 735 x 2230 mm 	GK-1010ST 	1.669,00
 <div style="position: absolute; top: 10px; right: 10px; background-color: red; color: white; padding: 5px; font-weight: bold; font-size: 1.2em;">NEU</div>	Getränkekühler 1038 Liter, 2 Schiebetüren <ul style="list-style-type: none"> · 1200 x 718 x 2145 mm · Innenmaß: 1100 x 590 x 1480 mm · Temperatur: +1°C/+10°C · Kapazität max. 1232 330 ml-Dosen · inkl. 5 Roste · Verpackungsmaße: 1215 x 735 x 2230 mm 	GK-1210ST 	1.779,00

°C +1/+10	L/net 498	kg/net 105	kg/br 115
--------------	--------------	---------------	--------------

°C +1/+10	L/net 620	kg/net 127	kg/br 140
--------------	--------------	---------------	--------------



°C +1/+10	L/net 805	kg/net 162	kg/br 170
--------------	--------------	---------------	--------------

°C +1/+10	L/net 1010	kg/net 195	kg/br 210
--------------	---------------	---------------	--------------

Kühlschränke - Edelstahl - Gastronomie

	Artikel	Code	Euro
<p>Neuer Türgriff</p> 	<p>Edelstahl Kühlschrank 200 Liter, 1 Klapptür</p> <ul style="list-style-type: none"> · 600 x 585 x 855 mm · Innenmaß: 510 x 485 x 620 mm · Temperatur: -2°C/+8°C · statische Kühlung mit Zwangsumwälzung · maximale Umgebungstemperatur: +16°C/+32°C · automatische Abtauung · 100 W, 230 V, 50 Hz, Verbrauch: 1,12 kWh/ 24h · Türanschlag wechselbar, abschließbar · digitaler Temperaturregler · 2 Rollen hinten und 2 FüÙe vorne · inkl. 2 Roste: 507 x 415 mm und 1 Bodenrost: 507 x 225 mm 	<p>HR200 S/SN</p> <p>A</p> <p>Kältemittel: 600a</p>	<p>659,00</p>
	<p>°C L/net ⚡ ⏏ auto kg/net kg/br</p> <p>-2/+8 78 100 W 230 V / 50 Hz 44 49</p>	<p>Rost: 507-415</p>	<p>36,00</p>
	<p>Edelstahl Kühlschrank 350 Liter, 1 Klapptür</p> <ul style="list-style-type: none"> · 600 x 585 x 1850 mm · Innenmaß: 510 x 485 x 1620 mm · Temperatur: -2°C/+8°C · statische Kühlung mit Zwangsumwälzung · maximale Umgebungstemperatur: +16°C/+32°C · automatische Abtauung · 130 W, 230 V, 50 Hz, Verbrauch: 1,31 kWh/ 24h · Türanschlag wechselbar, abschließbar · digitaler Temperaturregler · 2 Rollen hinten und 2 FüÙe vorne · inkl. 3 Roste: 507 x 415 mm und 1 Bodenrost: 507 x 225 mm 	<p>HR400 S/SN</p> <p>C</p> <p>Kältemittel: 600a</p>	<p>1.029,00</p>
	<p>°C L/net ⚡ ⏏ auto kg/net kg/br</p> <p>-2/+8 265 130 W 230 V / 50 Hz 69 79</p>	<p>Rost: 507-415</p>	<p>36,00</p>
	<p>Edelstahl Kühlschrank 520 Liter, 1 Klapptür</p> <ul style="list-style-type: none"> · 777 x 715 x 1720 mm · Innenmaß: 667 x 570 x 1485 mm · Temperatur: -2°C/+8°C · Umluftkühlung · maximale Umgebungstemperatur: +16°C/+32°C · manuelle Abtauung · 130 W, 230 V, 50 Hz · Türanschlag wechselbar, abschließbar · digitaler Temperaturregler · 2 Rollen hinten und 2 FüÙe vorne · inkl. 3 Roste: 3x 652 x 530 mm 	<p>HR500 S/SN</p> <p>C</p> <p>Kältemittel: 600a</p>	<p>1.279,00</p>
	<p>°C L/net ⚡ ⏏ man kg/net kg/br</p> <p>-2/+8 410 130 W 230 V / 50 Hz 90 105</p>	<p>Rost: 652-530</p>	<p>38,00</p>
	<p>Edelstahl Kühlschrank 620 Liter, 1 Klapptür</p> <ul style="list-style-type: none"> · 777 x 695 x 1895 mm · Innenmaß: 667 x 580 x 1660 mm · Temperatur: -2°C/+8°C · statische Kühlung mit Zwangsumwälzung · maximale Umgebungstemperatur: +16°C/+32°C · automatische Abtauung · 130 W, 230 V, 50 Hz · Türanschlag wechselbar, abschließbar · digitaler Temperaturregler · 2 Rollen hinten und 2 FüÙe vorne · inkl. 3 Roste: 654 x 525 mm und 1 Bodenrost: 654 x 330 mm 	<p>HR602 S/SN</p> <p>C</p> <p>Kältemittel: 600a</p>	<p>1.339,00</p>
	<p>°C L/net ⚡ ⏏ auto kg/net kg/br</p> <p>-2/+8 476 130 W 230 V / 50 Hz 90 109</p>	<p>Rost: 654-525</p>	<p>37,00</p>

Edelstahl Kühlschränke

	Artikel	Code	Euro
	<p>Edelstahl Kühlschrank 510 Liter, Semi Profi</p> <ul style="list-style-type: none"> · 895 x 745 x 1788 mm · Temperatur: +4°C/-22°C · 130 W, 230 V, 50 Hz · Verbrauch: 1,11 kW/ 24h · Kühlschrank 335 Liter · Gefrierschrank 175 Liter · automatische Abtauung · 4 Glasablageflächen · 2x 5 Türablagen, 2x 2 Schubladen · 3 offene Gefrierfächer · mit Temperaturanzeige · inkl. Eisbereiter Flaschenregal · Verpackungsmaß: 963 x 778 x 1855 mm 	<p>KGK-689</p> <p>A+</p> <p>Kältemittel: 600a</p>	<p>1.099,00</p>
	<p>°C +4/-22</p> <p>130 W</p> <p>230 V / 50 Hz</p> <p>1,11 kWh</p> <p>auto</p> <p>kg/net 90</p> <p>kg/br 100</p>		
 <p>700 mm</p>	<p>Edelstahl Kühlschrank 510 Liter, 1 Klapptür</p> <ul style="list-style-type: none"> · 680 x 700 x 1990 mm · Innenmaß: 560 x 580 x 1380 mm · Temperatur: -2°C/+8°C · statische Kühlung mit Walzenlüfter · automatische Abtauung · 300 W, 230 V, 50 Hz, Verbrauch: 1,12 kW/24h · Tür abschließbar, inkl. 3 Roste: 530 x 540 mm · Verpackungsmaß: 710 x 740 x 2150 mm 	<p>UK507.01</p> <p>C</p> <p>Kältemittel: 600a</p>	<p>1.479,00</p>
	<p>°C -2/+8</p> <p>L/net 313</p> <p>300 W</p> <p>230 V / 50 Hz</p> <p>1,12 kWh</p> <p>auto</p> <p>kg/net 105</p> <p>kg/br 113</p>	<p>Rost: 530-540</p>	<p>32,00</p>
  <p>ohne Behälter</p>	<p>Fischkühlschrank Edelstahl 537 Liter, 1 Klapptür, Edelstahl</p> <ul style="list-style-type: none"> · 680 x 810 x 2010 mm · Innenmaß: 560 x 680 x 1380 mm · Temperatur: -2°C/+8°C · statische Kühlung mit Walzenlüfter · automatische Abtauung · 300 W, 230 V, 50 Hz · Verbrauch: 2,9 kW/24h · Tür abschließbar · Verpackungsmaß: 710 x 840 x 2070 mm <p>Fischbehälter</p> <ul style="list-style-type: none"> · 600 x 400 x 120 mm 	<p>UK507FISH.01</p> <p>C</p> <p>Kältemittel: R600a</p>	<p>1.899,00</p>
	<p>°C -2/+8</p> <p>L/net 376</p> <p>300 W</p> <p>230 V / 50 Hz</p> <p>2,9 kWh</p> <p>auto</p> <p>kg/net 145</p> <p>kg/br 155</p>	<p>Box-507F</p>	<p>45,00</p>









	Artikel	Code	Euro
	Edelstahl Kühlschrank 400 Liter, 1 Glastür · 600 x 620 x 1900/2080 mm · Innenmaß: 530 x 500 x 1370 mm · Temperatur: 0°C/+10°C · Umluftkühlung · 385 W, 230 V, 50 Hz · Verbrauch: 2,5 kWh/24h · mit Monoblockaggregat, · inkl. 3 rilsanierten Rosten (530 x 325 mm) und 3 Paar Edelstahlschienen	Plus400 	1.829,00
	400 Liter, 1 Glastür	Plus 400Glas	1.949,00
	GN °C L/net ⚡ 230 V/50 Hz 1/1 0/+10 246 385 W	Rost: 530-325	57,00
	Edelstahl Kühlschrank 600 Liter, 1 Tür · 710 x 700 x 2030/2100 mm · Innenmaß: 590 x 580 x 1510 mm · Temperatur: 0°C/+10°C · Umluftkühlung · 385 W, 230 V, 50 Hz · Verbrauch: 1,76 kW / 24h · Belastung je Rost: 30 kg · inkl. Aggregat und 3 Roste: 530 x 550 mm · Verpackungsmaß: 750 x 750 x 2200 mm	UK600 	2.100,00
	°C L/net ⚡ 230 V/50 Hz 0/+10 385 385 W	Rost: 530-325	57,00
 <div style="border: 1px solid blue; border-radius: 50%; padding: 5px; display: inline-block; color: white; background-color: #007bff; margin-left: 10px;"> GN 2/1 STANDARD </div>	Edelstahl Kühlschrank 700 Liter, 1 Tür · 710 x 800 x 2030/2100 mm · Innenmaß: 590 x 670 x 1500 mm · Temperatur: 0°C/+10°C · 385 W, 230 V, 50 Hz · Verbrauch: 2,64 kWh/24h · mit Monoblockaggregat · inkl. 3 rilsanierten Rosten (530 x 650 mm) und 3 Paar Edelstahlschienen	UK700 	1.929,00
	°C L/net ⚡ 230 V/50 Hz ⏰ kg/net kg/br 0/+10 455 385 W 2,64 kWh 24h 107 123	Rost: 530-650	58,00

Kühlschränke Umluft - 700 tief

Allgemeine Beschreibung

- innen und außen aus Edelstahl
- automatische Abtauung und Wasserabführung
- 70 mm Isolation aus Polyurethan
- Zinkplatte auf der Rückseite
- Heizrohre verhindern Condensation
- leistungsstarker Kompressor
- Tür abschließbar

	Artikel	Code	Euro															
 <p>700 mm</p>	Kühlschrank 410 Liter, 1 Tür, Edelstahl <ul style="list-style-type: none"> · 600 x 700 x 1900 mm · Innenmaß: 495 x 590 x 1400 mm · Temperatur: +0°C/+10°C · Umluftkühlung · 300 W, 230 V, 50 Hz · automatische Abtauung · Verbrauch: 1,5 kW/24h · inkl. 3 Roste: 474 x 515 mm · Verpackungsmaß: 630 x 780 x 2000 mm 	Plus500.01  	1.629,00															
	<table border="1"> <tr> <td>°C</td> <td>L/net</td> <td>⚡</td> <td>230 V / 50 Hz</td> <td>24h</td> <td>auto</td> <td>kg/net</td> <td>kg/br</td> </tr> <tr> <td>0/+10</td> <td>310</td> <td>300 W</td> <td>1,5 kWh</td> <td></td> <td></td> <td>73</td> <td>87</td> </tr> </table>	°C	L/net	⚡	230 V / 50 Hz	24h	auto	kg/net	kg/br	0/+10	310	300 W	1,5 kWh			73	87	Rost: 474-515
°C	L/net	⚡	230 V / 50 Hz	24h	auto	kg/net	kg/br											
0/+10	310	300 W	1,5 kWh			73	87											
 <p>700 mm</p>	Edelstahl Kühlschrank 890 Liter, 2 Türen <ul style="list-style-type: none"> · 1215 x 700 x 1900 mm · Innenmaß: 1110 x 590 x 1400 mm · Temperatur: +0°C/+10°C · Umluftkühlung, leistungsstarker Kompressor · 380 W, 230 V, 50 Hz · automatische Abtauung und Wasserabführung · Verbrauch: 3,6 kW/24h · Füße höhenverstellbar · innen und außen Edelstahl · Tür abschließbar, 70 mm Isolation · inkl. 6 Roste: 497 x 515 mm · Verpackungsmaß: 1245 x 780 x 1930 mm 	Plus1000.01  	2.469,00															
	<table border="1"> <tr> <td>°C</td> <td>L/net</td> <td>⚡</td> <td>230 V / 50 Hz</td> <td>24h</td> <td>auto</td> <td>kg/net</td> <td>kg/br</td> </tr> <tr> <td>0/+10</td> <td>620</td> <td>380 W</td> <td>3,6 kWh</td> <td></td> <td></td> <td>120</td> <td>125</td> </tr> </table>	°C	L/net	⚡	230 V / 50 Hz	24h	auto	kg/net	kg/br	0/+10	620	380 W	3,6 kWh			120	125	Rost: 497-515
°C	L/net	⚡	230 V / 50 Hz	24h	auto	kg/net	kg/br											
0/+10	620	380 W	3,6 kWh			120	125											

Kühlschränke Umluft - 830 mm tief

Allgemeine Beschreibung

- innen und außen aus Edelstahl
- automatische Abtauung und Wasserabführung
- 70 mm Isolation aus Polyurethan
- Zinkplatte auf der Rückseite
- Heizrohre verhindern Condensation
- leistungsstarker Kompressor
- Tür abschließbar

	Artikel	Code	Euro															
 <p>830 mm</p>	Edelstahl Kühlschrank 589 Liter <ul style="list-style-type: none"> · 740 x 830 x 2000 mm · Innenmaß: 600 x 680 x 1400 mm · Temperatur: -2°C/+8°C · Umluftkühlung · automatische Abtauung · 255 W, 230 V, 50 Hz · Verbrauch: 1,74 kW/24h · Füße höhenverstellbar · innen und außen Edelstahl · Tür abschließbar · inkl. 3 Roste: 3x 630 x 534 mm 	Plus700N  	1.569,00															
	<table border="1"> <tr> <td>°C</td> <td>L/net</td> <td>⚡</td> <td>230 V / 50 Hz</td> <td>24h</td> <td>auto</td> <td>kg/net</td> <td>kg/br</td> </tr> <tr> <td>-2/+8</td> <td>444</td> <td>255 W</td> <td>230 V / 50 Hz</td> <td>1,74 kWh</td> <td>auto</td> <td>121</td> <td>137</td> </tr> </table>	°C	L/net	⚡	230 V / 50 Hz	24h	auto	kg/net	kg/br	-2/+8	444	255 W	230 V / 50 Hz	1,74 kWh	auto	121	137	Rost: 630-534
°C	L/net	⚡	230 V / 50 Hz	24h	auto	kg/net	kg/br											
-2/+8	444	255 W	230 V / 50 Hz	1,74 kWh	auto	121	137											
 <p>830 mm</p>	Edelstahl Kühlschrank 1311 Liter <ul style="list-style-type: none"> · 1480 x 830 x 2000 mm · Innenmaß: 1340 x 680 x 1400 mm · Temperatur: -2°C/+8°C · Umluftkühlung · automatische Abtauung · 400 W, 230 V, 50 Hz · Verbrauch: 2,82 kW/24h · Füße höhenverstellbar · innen und außen Edelstahl · Türen abschließbar · inkl. 9 Roste: 6x 630 x 534 mm, 3x 545 x 228 mm 	Plus1400N  	2.299,00															
	<table border="1"> <tr> <td>°C</td> <td>L/net</td> <td>⚡</td> <td>230 V / 50 Hz</td> <td>24h</td> <td>auto</td> <td>kg/net</td> <td>kg/br</td> </tr> <tr> <td>0/+10</td> <td>840</td> <td>380 W</td> <td>230 V / 50 Hz</td> <td>3,8 kWh</td> <td>auto</td> <td>165</td> <td>170</td> </tr> </table>	°C	L/net	⚡	230 V / 50 Hz	24h	auto	kg/net	kg/br	0/+10	840	380 W	230 V / 50 Hz	3,8 kWh	auto	165	170	Rost: 630-534
°C	L/net	⚡	230 V / 50 Hz	24h	auto	kg/net	kg/br											
0/+10	840	380 W	230 V / 50 Hz	3,8 kWh	auto	165	170											



Bäckereikühlschrank / -tische











	Artikel	Code	Euro
 <p>BN 600 x 400 Standard</p> <p>Edelstahl</p>	<p>Bäckereikühlschrank 852 Liter, 1 Tür, Edelstahl</p> <ul style="list-style-type: none"> · 740 x 990 x 2010 mm · Innenmaß: 620 x 861 x 1397 mm · Temperatur: +2°C/+8°C · Umluftkühlung, automatische Abtauung · 330 W, 230 V, 50 Hz · Türmaß: 724 x 55 x 1507 mm · Tür abschließbar · 10 Einschübe · Blechmaß: 600 x 400 mm · Verpackungsmaß: 765 x 1015 x 2070 mm 	<p>BKU800.01</p> <p>C</p> <p>Kältemittel: R290</p>	<p>2.449,00</p>
	<p>BN °C ⚡ auto kg/net kg/br</p> <p>600x400 +2/+8 330 W 143 161</p>	<p>Rost: 600-800</p>	<p>25,00</p>
	<p>Konditorei Kühltisch 240 Liter (netto), 3 Türen</p> <ul style="list-style-type: none"> · 1470 x 720 x 850 mm · Temperatur: 0°C/+8°C · statische Kühlung · 230 W, 230 V, 50 Hz · Verbrauch: 1,45 kW/24h · außen & Innenmaß aus Lebensmittelqualität Edelstahl · Türen mit Automatikverschluss <p>mit Granitarbeitsplatte</p>	<p>10103201.01</p>	<p>2.469,00</p>
	<p>°C ⚡ 230 V/50 Hz kg/net kg/br</p> <p>0/+8 230 W 130 154</p>	<p>10103201G.01</p>	<p>2.679,00</p>
	<p>Konditorei Kühltisch 360 Liter (netto), 3 Türen</p> <ul style="list-style-type: none"> · 1980 x 720 x 850 mm · Temperatur: 0°C/+8°C · statische Kühlung · 276 W, 230 V, 50 Hz · außen & Innenmaß aus Lebensmittelqualität Edelstahl · Türen mit Automatikverschluss 	<p>10103202.01</p>	<p>3.149,00</p>
	<p>°C ⚡ 230 V/50 Hz kg/net kg/br</p> <p>0/+8 276 W 166 192</p>	<p>10103203.01</p>	<p>3.799,00</p>
	<p>Konditorei Kühltisch 360 Liter (netto), 3 Türen</p> <ul style="list-style-type: none"> · 2490 x 720 x 850 mm · Temperatur: 0°C/+8°C · statische Kühlung · 386 W, 230 V, 50 Hz · außen & Innenmaß aus Lebensmittelqualität Edelstahl · Türen mit Automatikverschluss 		
	<p>°C ⚡ 230 V/50 Hz kg/net kg/br</p> <p>0/+8 386 W 202 237</p>		









Weinkühlschränke / Humidor

	Artikel	Code	Euro
	Humidor mit Hygrometer für Anzeige der Luftfeuchtigkeit, 33 Liter <ul style="list-style-type: none"> · 340 x 510 x 468 mm · Innenmaß: 340 x 510 x 468 mm · Temperatur: +10°C/+18°C · thermoelektrische Kühlung, 140 W, 230 V, 50 Hz · Vibrationsarme Technik, flüsterleise · blaue LED Innenbeleuchtung, Umweltfreundlich · stabile Feuchtigkeit & Temperatur · einstellbare Temperaturregelung · FCKW-frei, inkl. 2 Holzkisten für Zigarren · Verpackungsmaß: 430 x 600 x 555 mm 	Smoke 	219,00
 <p>2 Zonen für Weiß- & Rotwein</p>	Weinkühlschrank für 12 Flaschen (750 ml), 2 Türen, 33 Liter, schwarz <ul style="list-style-type: none"> · 254 x 515 x 731 mm · Innenmaß: 2x 171 x 331 x 276 mm · Temperatur: +7°C/+18°C · thermoelektrische Kühlung · 140 W, 230 V, 50 Hz · 2 Zonen für Weiß- und Rotwein · LED-Display, Innenbeleuchtung · besonders geräusch- und vibrationsarm · Türen mit Doppelverglasung · inkl. 4 verchromte Roste · Verpackungsmaß: 295 x 560 x 760 mm 	WS-12CD 	229,00
 <p>2 Zonen für Weiß- & Rotwein</p>	Weinkühlschrank für 21 Flaschen, 1 Tür, 70 Liter, schwarz <ul style="list-style-type: none"> · 345 x 515 x 804 mm · Innenmaß: <ul style="list-style-type: none"> ↑ 190 x 335 x 257 mm, ↓ 445 x 335 x 257 mm · Temperatur: ↑ +7°C/+18°C, ↓ +11°C/+18°C · thermoelektrische Kühlung · 140 W, 230 V, 50 Hz · 2 Zonen für Weiß- und Rotwein · LED-Display, Innenbeleuchtung · besonders geräusch- und vibrationsarm · Tür mit Doppelverglasung und Griff · inkl. 6 verchromte Roste · Verpackungsmaß: 400 x 570 x 835 mm 	WS-21C 	269,00
 <p>2 Zonen für Weiß- & Rotwein</p>	Weinkühlschrank für 21 Flaschen, 1 Tür, 70 Liter, Tür in silber <ul style="list-style-type: none"> · 345 x 515 x 804 mm · Innenmaß: <ul style="list-style-type: none"> ↑ 190 x 335 x 257 mm, ↓ 445 x 335 x 257 mm · Temperatur: ↑ +7°C/+18°C, ↓ +11°C/+18°C · thermoelektrische Kühlung · 140 W, 230 V, 50 Hz · 2 Zonen für Weiß- und Rotwein · LED-Display, Innenbeleuchtung · besonders geräusch- und vibrationsarm · Tür mit Doppelverglasung und Griff · inkl. 6 verchromte Roste · Verpackungsmaß: 400 x 570 x 835 mm 	WS-21T 	279,00



Weinkühlschränke

	Artikel	Code	Euro
	<p>Weinkühlschrank für 12 Flaschen (0,33 Liter), 33 Liter</p> <ul style="list-style-type: none"> · 340 x 468 x 510 mm · Temperatur: +10°C/+18°C · thermoelektrische Kühlung · besonders geräusch- und vibrationsarm · blaue LED Innenbeleuchtung · grünes LED Display · Edelstahltür mit Glaseinsatz · inkl. 3 Metallböden · Verpackungsmaß: 430 x 555 x 600 mm 	<p>WK610</p> 	<p>199,00</p>
	<p>Weinkühlschrank für 12 Flaschen, 33 Liter</p> <ul style="list-style-type: none"> · 345 x 510 x 525 mm · Innenmaß: 2x 255 x 325 x 200 mm · Temperatur: ↑ +7°C/+18°C, ↓ +10°C/+18°C · 140 W, 230 V, 50 Hz · 2 Zonen á 6 Flaschen für Weiß-& Rotwein · Zonen einzeln einstellbar · besonders geräusch- und vibrationsarm · blaue LED Ist-Temperaturanzeige · blaue zuschaltbare LED Innenbeleuchtung · Edelstahltür mit Sicherheitsglaseinsatz · inkl. 4 herausnehmbare Holzlagerböden · Verpackungsmaß: 430 x 595 x 620 mm 	<p>WK620</p> 	<p>359,00</p>
<p>2 Zonen für Weiß-& Rotwein</p>	<p>↑ °C +7/+18 ↓ °C +10/+18 12 140 W 230 V / 50 Hz kg/net 14 kg/br 17</p>		
	<p>Weinkühlschrank für 18 Flaschen, 55 Liter</p> <ul style="list-style-type: none"> · 345 x 507 x 718 mm · Temperatur: ↑ 7°C/18°C, ↓ 11°C/18°C · 140 W, 230 V, 50 Hz · 2 Zonen für Weiß-& Rotwein · Zonen einzeln einstellbar, automatische Abtauung · Innenbeleuchtung mit Schalter · besonders geräusch- und vibrationsarm · LED-Temperaturanzeige, kein Kompressor · Edelstahltür mit Doppelverglasung und Griff · inkl. 5 Holzlagerböden, höhenverstellbare Füße · Verpackungsmaß: 400 x 570 x 767 mm 	<p>WK622</p> 	<p>369,00</p>
<p>2 Zonen für Weiß-& Rotwein</p>	<p>↑ °C +7/+18 ↓ °C +11/+18 18 140 W 230 V / 50 Hz auto kg/net 17,5 kg/br 19,5</p>		
	<p>Weinkühlschrank für 27 Flaschen, 90 Liter</p> <ul style="list-style-type: none"> · 345 x 506 x 985 mm · Innenmaß: ↑ 278 x 340 x 290 mm, ↓ 278 x 340 x 540 mm · Temperatur: ↑ 7°C/18°C, ↓ 11°C/18°C · 140 W, 230 V, 50 Hz · 2 Zonen für Weiß-& Rotwein · Zonen einzeln einstellbar, automatische Abtauung · Innenbeleuchtung mit Schalter · LED-Temperaturanzeige, kein Kompressor · besonders geräusch- und vibrationsarm · Edelstahltür mit Doppelverglasung und Griff · inkl. 8 Holzlagerböden, höhenverstellbare Füße · Verpackungsmaß: 400 x 570 x 1035 mm 	<p>WK636</p> 	<p>419,00</p>
<p>2 Zonen für Weiß-& Rotwein</p>	<p>↑ °C +7/+18 ↓ °C +11/+18 27 140 W 230 V / 50 Hz auto kg/net 22,9 kg/br 25,1</p>		



Weinkühlschränke

	Artikel	Code	Euro
 <p>2 Zonen für Weiß- & Rotwein</p>	<p>Weinkühlschrank für 21 Flaschen, 60 Liter</p> <ul style="list-style-type: none"> · 345 x 510 x 805 mm · Temperatur: ↑ 7°C/18°C, 6 Flaschen, ↓ 10°C/18°C, 15 Flaschen · 140 W, 230 V, 50 Hz · 2 Zonen für Weiß- und Rotwein · zwei Kühlsysteme · besonders geräusch- und vibrationsarm · blaue LED Ist-Temperaturanzeige · blaue zuschaltbare LED Innenbeleuchtung · Edelstahltür mit Sicherheitsglaseinsatz und Griff · inkl. 6 herausnehmbare Holzlagerböden · Verpackungsmaß: 430 x 600 x 905 mm 	<p>WK630</p> <p>B</p> 	<p>429,00</p>
 <p>2 Zonen für Weiß- & Rotwein</p>	<p>Weinkühlschrank für 38 Flaschen</p> <ul style="list-style-type: none"> · 500 x 537 x 855 mm · Temperatur: ↑ +5°C/+10°C, ↓ +10°C/+18°C · Umluftkühlung · 85 W, 230 V, 50 Hz · 2 Zonen für Weiß- und Rotwein · LED-Display · Edelstahltür mit Doppelverglasung und Griff · Innenbeleuchtung, Tür abschließbar · inkl. 5 ausziehbare Holzlagerböden · Verpackungsmaß: 540 x 570 x 890 mm 	<p>WS-42DZ</p> <p>B</p> 	<p>639,00</p>
 <p>2 Zonen für Weiß- & Rotwein</p>	<p>Weinkühlschrank für 24 Flaschen, 90 Liter</p> <ul style="list-style-type: none"> · 395 x 545 x 875 mm · Innenmaß: 408 x 315 x 760 mm · Temperatur: +5°C/20°C · 60 W, 230 V, 50 Hz · 2 Zonen für Weiß- und Rotwein · aktive Lüfter je Zone für gleichmäßige Temperaturverteilung · vibrationsarme Kompressortechnik · blaue LED Ist-Temperaturanzeige · zuschaltbare Innenbeleuchtung · Edelstahltür mit Sicherheitsglaseinsatz · inkl. 4 herausnehmbare Holzlagerböden · Verpackungsmaß: 470 x 590 x 920 mm 	<p>WK645</p> <p>A</p> 	<p>859,00</p>
 <p>2 Zonen für Weiß- & Rotwein</p>	<p>Weinkühlschrank für 43 Flaschen, 131 Liter</p> <ul style="list-style-type: none"> · 400 x 625 x 1020 mm · Temperatur: +5°C/+22°C · 60 W, 230 V, 50 Hz · vibrationsarme Kompressortechnik · blaue LED Ist-Temperaturanzeige · zuschaltbare Innenbeleuchtung · Edelstahltür mit Sicherheitsglaseinsatz · inkl. 8 Holzlagerböden mit kugelgelagerten Auszügen · Verpackungsmaß: 455 x 675 x 1100 mm 	<p>WK647</p> <p>A</p> 	<p>869,00</p>



Weinkühlschränke

	Artikel	Code	Euro
 <p>2 Zonen für Weiß-& Rotwein</p>	<p>Weinkühlschrank für 38 Flaschen, 125 Liter</p> <ul style="list-style-type: none"> · 400 x 625 x 1025 mm · Innenmaß: <ul style="list-style-type: none"> ↑ 310 x 445 x 360 mm, ↓ 310 x 340 x 455 mm · Temperatur: +5°C/+20°C · 60 W, 230 V, 50 Hz · 2 Zonen für Weiß- und Rotwein · aktive Lüfter je Zone für gleichmäßige Temperaturverteilung · Zonen separat regelbar · leise und vibrationsarme Kompressortechnik · blaue LED Ist-Temperaturanzeige · zuschaltbare Innenbeleuchtung · Edelstahltür mit Sicherheitsglaseinsatz · inkl. 7 ausziehbare Holzlagerböden · Verpackungsmaß: 455 x 675 x 1130 mm 	<p>WK650</p> <p>A</p> <p>Kältemittel: R600a</p>	<p>879,00</p>
 <p>2 Zonen für Weiß-& Rotwein</p>	<p>Weinkühlschrank für 66 Flaschen</p> <ul style="list-style-type: none"> · 595 x 630 x 1034 mm · Innenmaß: 493 x 515 x 920 mm · Temperatur: +5°C/+20°C · 120 W, 230 V, 41,6 db · 2 Zonen für Weiß- und Rotwein · aktive Lüfter je Zone für gleichmäßige Temperaturverteilung · Zonen separat regelbar · leise und vibrationsarme Kompressortechnik · blaue LED Ist-Temperaturanzeige · zuschaltbare Innenbeleuchtung · Edelstahltür mit Sicherheitsglaseinsatz · Isolier Sicherheitsglas mit UV-Filter · inkl. 7 ausziehbare Holzlagerböden · Verpackungsmaß: 655 x 685 x 1100 mm 	<p>WK660</p> <p>A</p> <p>Kältemittel: R600a</p>	<p>1.259,00</p>
 <p>2 Zonen für Weiß-& Rotwein</p>	<p>Weinkühlschrank für 62 Flaschen</p> <ul style="list-style-type: none"> · 595 x 675 x 1120 mm · Innenmaß: 550 x 598 x 916 mm · Temperatur: ↑ +5°C/+10°C, ↓ +10°C/18°C · Umluftkühlung · 200 W, 230 V, 50 Hz · LED-Display · Edelstahlürrahmen mit Doppelverglasung und Griff · Innenbeleuchtung · Tür abschließbar · inkl. 7 ausziehbare Holzlagerböden · Verpackungsmaß: 645 x 745 x 1135 mm 	<p>WS-89DZ</p> <p>D</p> <p>Kältemittel: R600a</p>	<p>1.189,00</p>

Weinkühlschränke





	Artikel	Code	Euro
 <p>2 Zonen für Weiß- & Rotwein</p>	<p>Weinkühlschrank für 117 Flaschen</p> <ul style="list-style-type: none"> · 595 x 680 x 1408 mm · Innen: 505 x 535 x 1190 mm · Temperatur: ↑ +5°C/+10°C, ↓ +10°C/+18°C · aktive Kühlung · 230 W, 230 V, 50 Hz · 2 Zonen für Weiß- & Rotwein · blaue zuschaltbare LED-Innenbeleuchtung mit Schalter · Edelstahltür mit Glaseinsatz (gehärtet) + Griff · einbaufähig oder freistehend · 100% FCKW & FKW frei · inkl. 11 ausziehbare Holzlagerböden · Verpackungsmaß: 663 x 736 x 1547 mm 	<p>WK655</p> <p>C</p> <p>Kältemittel: R600a</p>	<p>1.449,00</p>
 <p>2 Zonen für Weiß- & Rotwein</p>	<p>Weinkühlschrank für 168 Flaschen</p> <ul style="list-style-type: none"> · 595 x 680 x 1780 mm · Innen: 505 x 535 x 1190 mm · Temperatur: ↑ +5°C/+10°C, ↓ +10°C/+18°C · aktive Kühlung · 230 W, 230 V, 50 Hz · 2 Zonen für Weiß- & Rotwein · blaue zuschaltbare LED-Innenbeleuchtung mit Schalter · Edelstahltür mit Glaseinsatz (gehärtet) + Griff · einbaufähig oder freistehend · 100% FCKW & FKW frei · inkl. 15 ausziehbare Holzlagerböden · Verpackungsmaß: 663 x 736 x 1922 mm 	<p>WK680</p> <p>D</p> <p>Kältemittel: R600a</p>	<p>1.389,00</p>
 <p>2 Zonen für Weiß- & Rotwein</p>	<p>Weinkühlschrank für 150 Flaschen</p> <ul style="list-style-type: none"> · 595 x 680 x 1871 mm · Temperatur: ↑ +5°C/ +10°C, ↓ +10°C/+18°C · Umluftkühlung, aktive Lüfter · 220 W, 230 V, 50 Hz · 2 Zonen für Weiß- & Rotwein · LED-Display · Edelstahltürrahmen mit Doppelverglasung und Griff · Innenbeleuchtung · Tür abschließbar · inkl. 15 ausziehbare Holzlagerböden (Buche) · Verpackungsmaß: 720 x 805 x 2120 mm 	<p>WS-168DZ</p> <p>D</p> <p>Kältemittel: R600a</p>	<p>1.489,00</p>

Weinkühlschränke

	Artikel	Code	Euro
 <p>2 Zonen für Weiß- & Rotwein</p>	<p>Weinkühlschrank für 180 Flaschen, 520 Liter</p> <ul style="list-style-type: none"> · 595 x 650 x 1860 mm · Innen: 591 x 515 x 1748 mm · Temperatur: +5°C/+20°C · 170 W, 230 V, 50 Hz · 2 Zonen für Weiß- & Rotwein · aktive Lüfter je Zone für gleichmäßige Temperaturverteilung · leise und vibrationsarme Kompressortechnik · blaue LED Ist-Temperaturanzeige · zuschaltbare Innenbeleuchtung · Edelstahltür mit Sicherheitsglaseinsatz · inkl. 8 Holzlagerböden · Verpackungsmaß: 660 x 750 x 1940 mm 	<p>WK670</p> <p>C</p> <p>Kältemittel: R600a</p>	<p>2.199,00</p>
	<p>°C +5/+20 180 170 W 230 V / 50 Hz kg/net 79,3 kg/br 94,6</p>		
	<p>Weinkühlschrank für 161 Flaschen, Edelstahl</p> <ul style="list-style-type: none"> · 595 x 698 x 1908 mm · Temperatur: +5°C/+20°C · Umluftkühlung, aktive Lüfter · 220 W, 230 V, 50 Hz · komplett aus Edelstahl · LED-Display · Edelstahltür mit Doppelverglasung und Griff · Innenbeleuchtung · Tür abschließbar · inkl. ausziehbare Holzböden · Verpackungsmaß: 720 x 823 x 2170 mm 	<p>WS-168E</p> <p>D</p> <p>Kältemittel: R600a</p>	<p>1.959,00</p>
	<p>°C +5/+20 161 220 W 230 V / 50 Hz kg/net 120 kg/br 130</p>		



Speise-Eismaschinen

	Artikel	Code	Euro
	<p>NEU</p> <p>Eismaschine 2 Liter, silber</p> <ul style="list-style-type: none"> · 284 x 424 x 262 mm · Temperatur: -18°C/-35°C · 180 W, 230 V, 50 Hz · vollautomatisch, Fassungsvermögen: 2 Liter · für Speiseeis, Sorbets & Frozen Joghurt · LCD Display, digitaler Timer · Produktionszyklus in 1 Stunde · erfordert kein Eis oder vorheriges Einfrieren · extra breite & tiefe Schüssel für einfaches Löffeln · erweiterte Kühlfunktion (10 Min.) · Verpackungsmaß: 353 x 496 x 324 mm 	<p>EIS15</p> 	<p>389,00</p>
	<p>°C -18/-35</p> <p>L 2</p> <p>⚡ 180 W</p> <p>230 V / 50 Hz</p> <p>kg/net 12</p> <p>kg/br 13,6</p>		
	<p>NEU</p> <p>Eismaschine 2 Liter, silber</p> <ul style="list-style-type: none"> · 272 x 315 x 362 mm · Temperatur: -18°C/-35°C · 180 W, 230 V, 50 Hz · vollautomatisch, Fassungsvermögen: 2 Liter · für Speiseeis, Sorbets & Frozen Joghurt · LCD Display, digitaler Timer · Produktionszyklus in 1 Stunde · erfordert kein Eis oder vorheriges Einfrieren · extra breite & tiefe Schüssel für einfaches Löffeln · erweiterte Kühlfunktion (20 Min.) · Verpackungsmaß: 390 x 330 x 432 mm 	<p>EIS20</p> 	<p>399,00</p>
	<p>°C -18/-35</p> <p>L 2</p> <p>⚡ 180 W</p> <p>230 V / 50 Hz</p> <p>kg/net 13</p> <p>kg/br 14,4</p>		



Saftmaschinen









	Artikel	Code	Euro
	Saftmaschine 12 Liter · 350 x 410 x 660 mm · Temperatur: 7°C/12°C · 230 W, 230 V, 50 Hz · Verpackungsmaß: 360 x 480 x 750 mm	SM121	589,00
	°C +7/+12 ⚡ 230 W 230 V / 50 Hz kg/net 18 kg / br 22		
	Saftmaschine 2x 12 Liter · 410 x 410 x 660 mm · Temperatur: 7°C/12°C · 380 W, 230 V, 50 Hz · Verpackungsmaß: 470 x 470 x 700 mm	SM122	719,00
	°C +7/+12 ⚡ 380 W 230 V / 50 Hz kg/net 30 kg / br 34,7		
	Saftmaschine 3x 12 Liter · 600 x 410 x 660 mm · Temperatur: 7°C/12°C · 380 W, 230 V, 50 Hz · Verpackungsmaß: 640 x 450 x 700 mm	SM123	829,00
	°C +7/+12 ⚡ 380 W 230 V / 50 Hz kg/net 30 kg / br 35		



Slush-Ice Maschinen

	Artikel	Code	Euro					
 	Slush-Ice Maschine 10 Liter · 290 x 560 x 760 mm · Temperatur: -2°C/-3°C · 300 W, 230 V, 50 Hz · Verpackungsmaß: 360 x 620 x 840 mm	SL101	1.635,00					
<table border="0"> <tr> <td>°C -2/-3</td> <td>⚡ 300 W</td> <td>🔌 230 V/ 50 Hz</td> <td>📦/net 27,8</td> <td>📦/br 38,71</td> </tr> </table>				°C -2/-3	⚡ 300 W	🔌 230 V/ 50 Hz	📦/net 27,8	📦/br 38,71
°C -2/-3	⚡ 300 W	🔌 230 V/ 50 Hz	📦/net 27,8	📦/br 38,71				
 	Slush-Ice Maschine 2x 10 Liter · 420 x 560 x 760 mm · Temperatur: -2°C/-3°C · 400 W, 230 V, 50 Hz · Verpackungsmaß: 470 x 620 x 840 mm	SL102	2.169,00					
<table border="0"> <tr> <td>°C -2/-3</td> <td>⚡ 400 W</td> <td>🔌 230 V/ 50 Hz</td> <td>📦/net 42,7</td> <td>📦/br 54,7</td> </tr> </table>				°C -2/-3	⚡ 400 W	🔌 230 V/ 50 Hz	📦/net 42,7	📦/br 54,7
°C -2/-3	⚡ 400 W	🔌 230 V/ 50 Hz	📦/net 42,7	📦/br 54,7				
 	Slush-Ice Maschine 3x 10 Liter · 600 x 560 x 780 mm · Temperatur: -2°C/-3°C · 500 W, 230 V, 50 Hz · Verpackungsmaß: 670 x 620 x 840 mm	SL103	2.569,00					
<table border="0"> <tr> <td>°C -2/-3</td> <td>⚡ 500 W</td> <td>🔌 230 V/ 50 Hz</td> <td>📦/net 57,75</td> <td>📦/br 73</td> </tr> </table>				°C -2/-3	⚡ 500 W	🔌 230 V/ 50 Hz	📦/net 57,75	📦/br 73
°C -2/-3	⚡ 500 W	🔌 230 V/ 50 Hz	📦/net 57,75	📦/br 73				
 	Slush-Ice Maschine 2x 12 Liter · 430 x 510 x 770 mm · Temperatur: -2°C/-3°C · 500 W, 230 V, 50 Hz · Verpackungsmaß: 470 x 550 x 870 mm	SL122	2.199,00					
<table border="0"> <tr> <td>°C -2/-3</td> <td>⚡ 500 W</td> <td>🔌 230 V/ 50 Hz</td> <td>📦/net 43,3</td> <td>📦/br 55,1</td> </tr> </table>				°C -2/-3	⚡ 500 W	🔌 230 V/ 50 Hz	📦/net 43,3	📦/br 55,1
°C -2/-3	⚡ 500 W	🔌 230 V/ 50 Hz	📦/net 43,3	📦/br 55,1				
 	Slush-Ice Maschine 3x 12 Liter · 610 x 510 x 770 mm · Temperatur: -2°C/-3°C · 600 W, 230 V, 50 Hz · Verpackungsmaß: 660 x 550 x 870 mm	SL123	2.569,00					
<table border="0"> <tr> <td>°C -2/-3</td> <td>⚡ 600 W</td> <td>🔌 230 V/ 50 Hz</td> <td>📦/net 63,75</td> <td>📦/br 78,54</td> </tr> </table>				°C -2/-3	⚡ 600 W	🔌 230 V/ 50 Hz	📦/net 63,75	📦/br 78,54
°C -2/-3	⚡ 600 W	🔌 230 V/ 50 Hz	📦/net 63,75	📦/br 78,54				

Gastronormbehälter

	Artikel	Code	Euro
	1/1 GN 530 x 325 x 20 mm 530 x 325 x 40 mm 530 x 325 x 65 mm 530 x 325 x 100 mm 530 x 325 x 150 mm 530 x 325 x 200 mm	GN1/1-20 GN1/1-40 GN1/1-65 GN1/1-100 GN1/1-150 GN1/1-200	10,00 13,00 15,00 19,00 26,00 35,00
	1/2 GN 325 x 265 x 20 mm 325 x 265 x 40 mm 325 x 265 x 65 mm 325 x 265 x 100 mm 325 x 265 x 150 mm 325 x 265 x 200 mm	GN1/2-20 GN1/2-40 GN1/2-65 GN1/2-100 GN1/2-150 GN1/2-200	7,00 8,50 10,00 12,00 17,00 22,00
	2/4 GN 530 x 165 x 20 mm 530 x 165 x 40 mm 530 x 165 x 65 mm 530 x 165 x 100 mm 530 x 165 x 150 mm	GN2/4-20 GN2/4-40 GN2/4-65 GN2/4-100 GN2/4-150	12,00 14,00 16,00 21,00 29,00
	1/4 GN 265 x 165 x 20 mm 265 x 165 x 40 mm 265 x 165 x 65 mm 265 x 165 x 100 mm 265 x 165 x 150 mm 265 x 165 x 200 mm	GN1/4-20 GN1/4-40 GN1/4-65 GN1/4-100 GN1/4-150 GN1/4-200	4,00 6,00 8,00 9,00 13,50 24,00
	2/3 GN 354 x 325 x 20 mm 354 x 325 x 40 mm 354 x 325 x 65 mm 354 x 325 x 100 mm 354 x 325 x 150 mm 354 x 325 x 200 mm	GN2/3-20 GN2/3-40 GN2/3-65 GN2/3-100 GN2/3-150 GN2/3-200	8,50 10,00 11,00 14,00 21,00 26,00
	1/3 GN 325 x 176 x 20 mm 325 x 176 x 40 mm 325 x 176 x 65 mm 325 x 176 x 100 mm 325 x 176 x 150 mm 325 x 176 x 200 mm	GN1/3-20 GN1/3-40 GN1/3-65 GN1/3-100 GN1/3-150 GN1/3-200	5,50 6,50 7,50 9,50 15,00 29,00
	1/6 GN 176 x 162 x 65 mm 176 x 162 x 100 mm 176 x 162 x 150 mm 176 x 162 x 200 mm	GN1/6-65 GN1/6-100 GN1/6-150 GN1/6-200	5,00 7,00 13,00 22,00
	1/9 GN 176 x 108 x 65 mm 176 x 108 x 100 mm 176 x 108 x 150 mm	GN1/9-65 GN1/9-100 GN1/9-150	4,40 6,00 14,00



2

Tiefkühlschränke

Tiefkühlschränke	36
Edelstahl-Tiefkühlschränke	37 - 43
Bäckerei-Tiefkühlschränke	38
Schockfroster	44

Tiefkühlschränke

	Artikel	Code	Euro
<p>Neuer Türgriff</p> 	<p>Tiefkühlschrank 200 Liter, weiß</p> <ul style="list-style-type: none"> · 600 x 585 x 855 mm · Innenmaß: 484 x 470 x 620 mm · Temperatur: -10°C/-25°C · statische Kühlung · manuelle Abtauung · 105 W, 230 V, 50 Hz · maximale Umgebungstemperatur: +32°C · Türanschlag wechselbar und abschließbar · inkl. 3 feste Roste · Verpackungsmaß: 680 x 650 x 1050 mm 	<p>TK202N</p> <p>A</p> <p>Kältemittel: R600a</p>	<p>569,00</p>
	<p>Tiefkühlschrank 400 Liter, weiß</p> <ul style="list-style-type: none"> · 600 x 585 x 1850 mm · Innenmaß: 480 x 470 x 1620 mm · Temperatur: -10°C/-25°C · statische Kühlung · manuelle Abtauung · 150 W, 230 V, 50 Hz · maximale Umgebungstemperatur: +32°C · Türanschlag wechselbar und abschließbar · inkl. 7 feste Roste · Verpackungsmaß: 680 x 650 x 2100 mm 	<p>TK402N</p> <p>B</p> <p>Kältemittel: R600a</p>	<p>929,00</p>
	<p>Tiefkühlschrank 520 Liter, weiß</p> <ul style="list-style-type: none"> · 777 x 715 x 1720 mm · Innen: 667 x 570 x 1485 mm · Temperatur: -10°C/-25°C · max Außentemperatur: +32°C · statische Kühlung, manuelle Abtauung · 300 W, 230 V, 50 Hz · Türmaß: 773 x 1544 mm, Türanschlag wechselbar · digitaler Temperaturregler · inkl. 6 feste Roste, abschließbar · Verpackungsmaß: 840 x 760 x 1920 mm 	<p>TK-500N</p> <p>C</p> <p>Kältemittel: R600a</p>	<p>1.129,00</p>
	<p>Tiefkühlschrank 600 Liter, weiß</p> <ul style="list-style-type: none"> · 777 x 695 x 1895 mm · Innenmaß: 653 x 580 x 1680 mm · Temperatur: -10°C/-22°C · statische Kühlung · manuelle Abtauung · 300 W, 230 V, 50 Hz · maximale Umgebungstemperatur: +32°C · Türanschlag wechselbar und abschließbar · inkl. 7 feste Roste · Verpackungsmaß: 840 x 760 x 2100 mm 	<p>TK602N</p> <p>B</p> <p>Kältemittel: R600a</p>	<p>1.289,00</p>

Tiefkühlschränke - Edelstahl









	Artikel	Code	Euro
<p>Neuer Türgriff</p> 	<p>Edelstahl Tiefkühlschrank 200 Liter, Edelstahl</p> <ul style="list-style-type: none"> · 600 x 585 x 855 mm · Innenmaß: 484 x 470 x 620 mm · Temperatur: -10°C/-25°C · statische Kühlung · manuelle Abtauung · 105 W, 230 V, 50 Hz · maximale Umgebungstemperatur: +32°C · Türanschlag wechselbar und abschließbar · inkl. 3 feste Roste · Verpackungsmaß: 680 x 650 x 1050 mm 	<p>TK-202 SSN</p> <p>A</p> <p>Kältemittel: R600a</p>	<p>719,00</p>
	<p>Edelstahl Tiefkühlschrank 400 Liter, Edelstahl</p> <ul style="list-style-type: none"> · 600 x 585 x 1850 mm · Innenmaß: 480 x 470 x 1620 mm · Temperatur: -10°C/-25°C · statische Kühlung · manuelle Abtauung · 150 W, 230 V, 50 Hz · maximale Umgebungstemperatur: +32°C · Türanschlag wechselbar und abschließbar · inkl. 7 feste Roste · Verpackungsmaß: 680 x 650 x 2100 mm 	<p>TK-402 SSN</p> <p>B</p> <p>Kältemittel: R600a</p>	<p>1.129,00</p>
 <p>NEU</p>	<p>Edelstahl Tiefkühlschrank 522 Liter, Edelstahl</p> <ul style="list-style-type: none"> · 777 x 715 x 1720 mm · Innenmaß: 667 x 570 x 1485 mm · Temperatur: -10°C/-25°C · statische Kühlung · manuelle Abtauung · 300 W, 230 V, 50 Hz · maximale Umgebungstemperatur: +32°C · Türanschlag wechselbar und abschließbar · inkl. 7 feste Roste (515 x 613 mm) · Verpackungsmaß: 680 x 650 x 2100 mm 	<p>TK-500 SSN</p> <p>C</p> <p>Kältemittel: R600a</p>	<p>1.319,00</p>
	<p>Edelstahl Tiefkühlschrank 600 Liter, Edelstahl</p> <ul style="list-style-type: none"> · 777 x 695 x 1895 mm · Innenmaß: 653 x 580 x 1680 mm · Temperatur: -10°C/-22°C · statische Kühlung · manuelle Abtauung · 300 W, 230 V, 50 Hz · maximale Umgebungstemperatur: +32°C · Türanschlag wechselbar und abschließbar · inkl. 6 feste Roste · Verpackungsmaß: 840 x 760 x 2100 mm 	<p>TK-602 SSN</p> <p>B</p> <p>Kältemittel: R600a</p>	<p>1.449,00</p>

Tiefkühlschränke

	Artikel	Code	Euro
	Tiefkühlschrank 118,5 Liter, weiß <ul style="list-style-type: none"> · 600 x 600 x 980 mm · Innenmaß: 484 x 470 x 620 mm · Temperatur: bis -10°C/-25°C · 360 W, 230 V, 50 Hz · statische Kühlung mit Zwangsumwälzung · automatische Abtauung · Verpackungsmaß: 680 x 650 x 1050 mm 	KS202.01 	859,00
	Tiefkühlschrank 240 Liter, weiß, Semiprofi <ul style="list-style-type: none"> · 570 x 595 x 1750 mm · Innenmaß: 456 x 413 x 1548 mm · Temperatur: bis -18°C · statische Kühlung · manuelle Abtauung · Verbrauch: 0,7 kWh/24h · Türanschlag wechselbar · Schnellfrost, Temperatur-Warnleuchte · inkl. 6 Fächer aus Kunststoff und 1 Klappe · Verpackungsmaß: 694 x 651 x 1821 mm 	MF-305  	699,00
  Edelstahl	Bäckereitiefkühlschrank Edelstahl, 852 Liter, 1 Tür <ul style="list-style-type: none"> · 740 x 990 x 2010 mm · Innen: 620 x 861 x 1397 mm · Temperatur: -18°C/-22°C · 750 W, 230 V, 50 Hz · Verbrauch: 8,38 kW/24h · 10 Einschübe · Umgebungstemperatur 30°C · max. Luftfeuchtigkeit: 55 	BTK800.01  	2.529,00
 	Thermobox, Bäckerei 50 Liter <ul style="list-style-type: none"> · 390 x 400 x 690 mm · Innenmaß: 300 x 300 x 590 mm · doppelwandig, Frontlader, stapelbar · widerstandsfähiges und robustes Material · inkl. 5 robuste Einlegebögen · Gewicht: 7 kg/7,5 kg 	Thermo630 	279,00
 	Thermobox, Bäckerei 150 Liter <ul style="list-style-type: none"> · 520 x 700 x 670 mm · Innenmaß: 410 x 610 x 550 mm · doppelwandig, Frontlader, stapelbar · widerstandsfähiges und robustes Material · 10 Einschubvorrichtungen (Abstand: 50 mm) · Gewicht: 14 kg/15 kg 	Thermo660 	519,00

Tiefkühlschränke























	Artikel	Code	Euro													
	Edelstahl Tiefkühlschrank 301 Liter <ul style="list-style-type: none"> · 484 x 735 x 2010 mm · Innenmaß: 368 x 580 x 1390 mm · Temperatur: -18°C/-22°C · Umluftkühlung · automatische Abtauung · 490 W, 230 V, 50 Hz · Tür abschließbar · Türmaß: 458 x 550 x 1485 mm · inkl. 3x Roste: 335 x 530 mm · Verpackungsmaß: 515 x 765 x 2070 mm 	TK350.01  	1.829,00													
	<table border="0"> <tr> <td>°C</td> <td>L/net</td> <td>⚡</td> <td>230 V / 50 Hz</td> <td>auto</td> <td>kg/net</td> <td>kg/br</td> </tr> <tr> <td>-18/-22</td> <td>230</td> <td>490 W</td> <td></td> <td></td> <td>110</td> <td>123</td> </tr> </table>	°C	L/net	⚡	230 V / 50 Hz	auto	kg/net	kg/br	-18/-22	230	490 W			110	123	Rost: 335-530
°C	L/net	⚡	230 V / 50 Hz	auto	kg/net	kg/br										
-18/-22	230	490 W			110	123										
	Edelstahl Tiefkühlschrank 500 Liter <ul style="list-style-type: none"> · 680 x 700 x 1990 mm · Innenmaß: 560 x 580 x 1380 mm · Temperatur: -10°C/-20°C · statische Kühlung mit Walzenlüfter · manuelle Abtauung · 490 W, 230 V, 50 Hz · Tür abschließbar · Digitalanzeige · inkl. 3 rilsanierte Roste: 530 x 540 mm · Verpackungsmaß: 710 x 740 x 2150 mm 	TK507.01  	1.749,00													
	<table border="0"> <tr> <td>°C</td> <td>L/net</td> <td>⚡</td> <td>230 V / 50 Hz</td> <td>man</td> <td>kg/net</td> <td>kg/br</td> </tr> <tr> <td>-10/-20</td> <td>313</td> <td>490 W</td> <td></td> <td></td> <td>108</td> <td>116</td> </tr> </table>	°C	L/net	⚡	230 V / 50 Hz	man	kg/net	kg/br	-10/-20	313	490 W			108	116	Rost: 530-540
°C	L/net	⚡	230 V / 50 Hz	man	kg/net	kg/br										
-10/-20	313	490 W			108	116										
	Edelstahl Tiefkühlschrank 400 Liter, 1 Tür <ul style="list-style-type: none"> · 600 x 620 x 1900/2080 mm · Temperatur: -18°C/-22°C · 385 W, 230 V, 50 Hz · mit Monoblockaggregat · Rostmaße: 530 x 325 mm · inkl. 3 rilsanierten Rosten · inkl. 3 Edelstahlschienen 	MINUS400 	2.090,00													
	<table border="0"> <tr> <td>°C</td> <td>⚡</td> <td>230 V / 50 Hz</td> <td>kg/net</td> <td>kg/br</td> </tr> <tr> <td>-18/-22</td> <td>385 W</td> <td></td> <td>68</td> <td>70</td> </tr> </table>	°C	⚡	230 V / 50 Hz	kg/net	kg/br	-18/-22	385 W		68	70					
°C	⚡	230 V / 50 Hz	kg/net	kg/br												
-18/-22	385 W		68	70												

**GN 1/1
STANDARD**

Tiefkühlschränke Umluft

Allgemeine Beschreibung





- innen und außen aus Edelstahl
- automatische Abtauung und Wasserabführung
- 70 mm Isolation aus Polyurethan
- Zinkplatte auf der Rückseite
- Heizrohre verhindern Condensation
- leistungsstarker Kompressor
- Tür abschließbar
- Kühlmittel R290

	Artikel	Code	Euro
 <p>700 mm</p>	Edelstahl Tiefkühlschrank 410 Liter, 1 Tür · 600 x 700 x 1900 mm · Innen: 495 x 590 x 1400 mm · Temperatur: -18°C/-22°C · 380 W, 230 V, 50 Hz · Umluftkühlung · 3 Roste: 474 x 515 mm · Verpackungsmaß: 630 x 710 x 2000 mm	Minus500.01  	1.839,00
		 °C -18/-22  L/net 310  380 W  230 V/ 50 Hz  kg/net 78  kg/br 92	Rost: 474-515
 <p>700 mm</p>	Edelstahl Tiefkühlschrank 890 Liter, 2 Türen · 1215 x 700 x 1900 mm · Innen: 1110 x 590 x 1400 mm · Temperatur: -18°C/-22°C · 680 W, 230 V, 50 Hz · Umluftkühlung · 6 Roste: 474 x 515 mm · Verpackungsmaß: 1245 x 710 x 2000 mm	Minus1000.01  	2.649,00
		 °C -18/-22  L/net 620  680 W  230 V/ 50 Hz  kg/net 125  kg/br 130	Rost: 474-515

Tiefkühlschränke Umluft - 830 Tiefe

Allgemeine Beschreibung

- innen und außen aus Edelstahl
- Umluftkühlung
- automatische Abtauung
- Kühlmittel: R290
- Umluftkühlung
- Füße höhenverstellbar
- Türen abschließbar





	Artikel	Code	Euro
 <p>830 mm</p> <p>GN 2/1</p>	<p>Tiefkühlschrank 589 Liter, Edelstahl</p> <ul style="list-style-type: none"> · 740 x 830 x 2000 mm · Innen: 600 x 680 x 1400 mm · Temperatur: -18°C/-22°C · Kühlmittel: R290 · Umluftkühlung · automatische Abtauung · 600 W, 230 V, 50 Hz · Füße höhenverstellbar · innen und außen Edelstahl, SS201 · Tür abschließbar · inkl. 3 Roste: 3x 630 x 534 mm 	<p>Minus700N</p> <p>D</p> <p>Kältemittel: R290</p>	<p>1.749,00</p>
	<p>°C -18/-22</p> <p>L/net 444</p> <p>600 W</p> <p>230 V / 50 Hz</p> <p>auto</p> <p>kg/net 123</p> <p>kg / br 139</p>	<p>Rost: 630-534</p>	<p>29,00</p>
 <p>830 mm</p> <p>GN 2/1</p>	<p>Tiefkühlschrank 1311 Liter, Edelstahl</p> <ul style="list-style-type: none"> · 1480 x 830 x 2000 mm · Innen: 1340 x 680 x 1400 mm · Temperatur: -18°C/-22°C · Kühlmittel: R290 · Umluftkühlung · automatische Abtauung · 770 W, 230 V, 50 Hz · Füße höhenverstellbar · innen und außen Edelstahl, SS201 · Türen abschließbar · inkl. 9 Roste: 6x 630 x 534 mm, 3x 545 x 228 mm 	<p>Minus1400N</p> <p>D</p> <p>Kältemittel: R290</p>	<p>2.559,00</p>
	<p>°C -18/-22</p> <p>L/net 1004</p> <p>770 W</p> <p>230 V / 50 Hz</p> <p>auto</p> <p>kg/net 187</p> <p>kg / br 213</p>	<p>Rost: 630-534</p>	<p>29,00</p>

Tiefkühlschrank & Zubehör



	Artikel	Code	Euro
	<p>Tiefkühlschrank 40 Liter, weiß, für Spirituosen</p> <ul style="list-style-type: none"> · 470 x 450 x 507 mm · Innenmaß: 345 x 345 x 370 · Temperatur: bis -18°C · statische Kühlung · 120 W, 230 V, 50 Hz · inkl. 1 Rost · Verpackungsmaß: 520 x 465 x 530 mm 	<p>BG-40</p>  <p>Kältemittel: R600a</p>	<p>209,00</p>
	<p>°C bis -18 ⚡ 120 W 230 V / 50 Hz kg/net 18 kg/br 19,5</p>		
	<p>Tiefkühl-Einlegebox aus Kunststoff</p> <p>515 x 310 x 175 mm</p> <p>620 x 300 x 185 mm</p> <p>598 x 370 x 190 mm</p>	<p>HF600-60</p> <p>HF600.61</p> <p>HF500-61</p>	<p>33,00</p> <p>33,00</p> <p>33,00</p>



	Artikel	Code	Euro
	Edelstahl-Tiefkühlschrank 600 Liter, 1 Tür · 710 x 700 x 2030/2100 mm · Temperatur: -18°C/-22°C · 650 W, 230 V, 50 Hz · mit Monoblockaggregat + Lüftungsstopp · Rostmaße: 530 x 550 mm · inkl. 3 rilsanierten Rosten · inkl. 3 Edelstahlschienen	TK600 	2.449,00
	Edelstahl Tiefkühlschrank 1200 Liter, 2 Türen · 1420 x 700 x 2030/2100 mm · Temperatur: -22°C/-18°C · 570 W, 230 V, 50 Hz · inkl. Monoblockaggregat · inkl. 6 Roste, 6 Edelstahlschienen · Verpackungsmaß: 1460 x 750 x 2200 mm	TK1200 	3.249,00
	Edelstahl-Tiefkühlschrank 700 Liter, 1 Tür · 710 x 800 x 2030 mm · Temperatur: -18°C/-22°C · 650 W, 230 V, 50 Hz · mit Monoblockaggregat · inkl. 3 rilsanierten Rosten: 530 x 650 mm · inkl. 3 Paar Edelstahlschienen	TK700 	2.629,00
	Edelstahl Tiefkühlschrank 1400 Liter, 2 Türen · 1420 x 800 x 2030/2100 mm · Temperatur: -22°C/-18°C · 700 W, 230 V, 50 Hz · inkl. Monoblockaggregat · inkl. 6 Roste, 6 Edelstahlschienen · Verpackungsmaß: 1460 x 850 x 2200 mm	TK1400 	3.479,00

°C -18/-22	L/net 385	⚡ 650 W	230 V / 50 Hz	kg/net 105	kg/br 116
---------------	--------------	------------	------------------	---------------	--------------

°C -22/-18	L/net 770	⚡ 570 W	230 V / 50 Hz	kg/net 155	kg/br 190
---------------	--------------	------------	------------------	---------------	--------------





°C -18/-22	L/net 455	⚡ 650 W	230 V / 50 Hz
---------------	--------------	------------	------------------

°C -22/-18	L/net 909	⚡ 700 W	230 V / 50 Hz	kg/net 174	kg/br 198
---------------	--------------	------------	------------------	---------------	--------------

Edelstahl - Schnellkühler & Schockfroster



Temperatur von +70°C auf +3°C in maximal 90 min./+70°C auf -18°C in maximal 240 min.

	Artikel	Code	Euro
 <p>3x GN1/1 oder Blech 600 x 400 mm</p>	<p>Schockfroster mit Aggregat 3x GN 1/1</p> <ul style="list-style-type: none"> · 750 x 740 x 720/750 mm · Innenmaß: 600 x 400 x 280 mm · Kapazität: 14 kg (+3°C)/11 kg (-18°C) · 1150 W, 230 V, 50 Hz · Abstand zw. Einschüben 70 mm · Verpackungsmaß: 800 x 800 x 1000 mm 	<p>AT03 ISO</p> <p>Kältemittel: R452a</p> <p>GN 3x 1/1</p>	<p>2.199,00</p>
	<p>1150 W 230 V / 50 Hz kg/net 50 kg/br 60</p>	<p>Rost: GRIDAT07</p>	<p>29,00</p>
 <p>5x GN1/1 oder Blech 600 x 400 mm</p>	<p>Schockfroster mit Aggregat 5x GN 1/1</p> <ul style="list-style-type: none"> · 750 x 740 x 850/880 mm · Innenmaß: 610 x 400 x 410 mm · Kapazität: 20 kg (+3°C)/15 kg (-18°C) · 1424 W, 230 V, 50 Hz · Abstand zw. Einschüben 70 mm · Verpackungsmaß: 800 x 800 x 1050 mm 	<p>AT05 ISO</p> <p>Kältemittel: R452a</p> <p>GN 5x 1/1</p>	<p>2.489,00</p>
	<p>1424 W 230 V / 50 Hz kg/net 60 kg/br 71</p>	<p>Rost: GRIDAT07</p>	<p>29,00</p>
 <p>7x GN1/1 oder Blech 600 x 400 mm</p>	<p>Schockfroster mit Aggregat 7x GN 1/1</p> <ul style="list-style-type: none"> · 750 x 740 x 1260/1290 mm · Innenmaß: 610 x 400 x 770 mm · Kapazität: 25 kg (+3°C)/20 kg (-18°C) · 1490 W, 230 V, 50 Hz · Abstand zw. Einschüben 70 mm · Verpackungsmaß: 800 x 800 x 1400 mm 	<p>AT07 ISO</p> <p>Kältemittel: R452a</p> <p>GN 7x 1/1</p>	<p>3.179,00</p>
	<p>1490 W 230 V / 50 Hz kg/net 85 kg/br 95</p>	<p>Rost: GRIDAT07</p>	<p>29,00</p>
 <p>10x GN1/1 oder Blech 600 x 400 mm</p>	<p>Schockfroster mit Aggregat 10x GN 1/1</p> <ul style="list-style-type: none"> · 750 x 740 x 1260/1290 mm · Innenmaß: 610 x 400 x 770 mm · Kapazität: 25 kg (+3°C)/20 kg (-18°C) · 2100 W, 230 V, 50 Hz · Abstand zw. Einschüben 70 mm · Verpackungsmaß: 800 x 800 x 1400 mm 	<p>AT10 ISO</p> <p>Kältemittel: R452a</p> <p>GN 10x 1/1</p>	<p>4.869,00</p>
	<p>2100 W 230 V / 50 Hz kg/net 90 kg/br 101</p>	<p>Rost: GRIDAT07</p>	<p>29,00</p>



3

Kühl- & Tiefkühltische

Serie 600	47 - 49
Unterbaukühltische	50 - 53
Serie 700	54 - 57
Mini-Kühltische 700	58 - 59
Bäckereikühltische	60 - 61
Tiefkühltische	62
Schockfroster	63

Vakuumiergeräte













	Artikel	Code	Euro
	<p>Vakuumiergerät</p> <ul style="list-style-type: none"> · 330 x 480 x 320 mm als Tischgerät · Kammer Größe: 280 x 385 x 100 mm (inkl. Deckel) · 370 W, 230 V, 50 Hz · Produktionszyklus: 1-2/min · Versieglungsmaß: 260 x 8 mm · Pumpenleistung: 10 m³/h · Geeignet für: goffierte und glatte Beutel 	<p>VAC 280</p>  <p>Ersatzteile beiliegend: Öl, Teflonband, Deckeldichtung, Schweißdraht</p>	<p>1.519,00</p>
	<p>Vakuumiergerät</p> <ul style="list-style-type: none"> · 425 x 560 x 410 mm als Tischgerät · Kammer Größe: 370 x 450 x 120 mm (inkl. Deckel) · 900 W, 230 V, 50 Hz · Produktionszyklus: 1-2/min · Versieglungsmaß: 350 x 8 mm · Pumpenleistung: 20 m³/h · Geeignet für: goffierte und glatte Beutel 	<p>VAC 350 M</p>  <p>Ersatzteile beiliegend: Öl, Teflonband, Deckeldichtung, Schweißdraht</p>	<p>1.889,00</p>
	<p>Vakuumiergerät</p> <ul style="list-style-type: none"> · 475 x 555 x 460 mm als Tischgerät · Kammer Größe: 420 x 440 x 200 mm (inkl. Deckel) · 900 W, 230 V, 50 Hz · Produktionszyklus: 1-2/min · Versieglungsmaß: 400 x 8 mm · Pumpenleistung: 20 m³/h · Geeignet für: goffierte und glatte Beutel 	<p>VAC 400 G</p>  <p>Ersatzteile beiliegend: Öl, Teflonband, Deckeldichtung, Schweißdraht</p>	<p>2.019,00</p>
	<p>Vakuumiergerät</p> <ul style="list-style-type: none"> · 475 x 555 x 1050 mm als Standgerät · Kammer Größe: 440 x 420 x 200 mm (inkl. Deckel) · 900 W, 230 V, 50 Hz · Produktionszyklus: 1-2/min · Versieglungsmaß: 400 x 8 mm · Pumpenleistung: 20 m³/h · Geeignet für: goffierte und glatte Beutel 	<p>VAC 440 GL</p>  <p>Ersatzteile beiliegend: Öl, Teflonband, Deckeldichtung, Schweißdraht</p>	<p>2.259,00</p>

Kühltische Serie 600

Abbildung
ähnlich!



GN
2/3

Artikel	Code	Euro														
Kühltisch 260 Liter, 2 Türen, GN 2/3 <ul style="list-style-type: none"> · 1360 x 600 x 860 mm · Innenmaß: 799 x 480 x 569 mm · Temperatur: -2°C/+8°C · Umluftkühlung, automatische Abtauung · 300 W, 230 V, 50 Hz, Verbrauch: 1,96 kW/24h · Rostmaß: 328 x 430 mm · Verpackungsmaß: 1390 x 630 x 910 mm · Gewicht: 100 kg/110 kg 	60-2.01  	1.649,00														
wie oben, jedoch mit Aufkantung (100 mm) <table border="1"> <tr> <td>GN</td> <td>°C</td> <td>L/net</td> <td>⚡</td> <td>230 V/50 Hz</td> <td>24h</td> <td>auto</td> </tr> <tr> <td>2/3</td> <td>-2/+8</td> <td>166</td> <td>300 W</td> <td>230 V/50 Hz</td> <td>1,96 kWh</td> <td></td> </tr> </table>	GN	°C	L/net	⚡	230 V/50 Hz	24h	auto	2/3	-2/+8	166	300 W	230 V/50 Hz	1,96 kWh		60-2A.01 	1.699,00
GN	°C	L/net	⚡	230 V/50 Hz	24h	auto										
2/3	-2/+8	166	300 W	230 V/50 Hz	1,96 kWh											
Kühltisch 260 Liter, 1 Tür, 2 Schubladen, GN 2/3 <ul style="list-style-type: none"> · 1360 x 600 x 860 mm · Innenmaß: 799 x 480 x 569 mm · Temperatur: -2°C/+8°C · Umluftkühlung, automatische Abtauung · 300 W, 230 V, 50 Hz, Verbrauch: 2,219 kW/24h · Rostmaß: 328 x 430 mm · Schubladenmaß: 430 x 320 mm · Verpackungsmaß: 1390 x 630 x 910 mm · Gewicht: 100 kg/110 kg 	60-2C2.01  	1.959,00														
wie oben, jedoch mit Aufkantung (100 mm) <table border="1"> <tr> <td>GN</td> <td>°C</td> <td>L/net</td> <td>⚡</td> <td>230 V/50 Hz</td> <td>24h</td> <td>auto</td> </tr> <tr> <td>2/3</td> <td>-2/+8</td> <td>163</td> <td>300 W</td> <td>230 V/50 Hz</td> <td>2,219 kWh</td> <td></td> </tr> </table>	GN	°C	L/net	⚡	230 V/50 Hz	24h	auto	2/3	-2/+8	163	300 W	230 V/50 Hz	2,219 kWh		60-2C2A.01 	1.999,00
GN	°C	L/net	⚡	230 V/50 Hz	24h	auto										
2/3	-2/+8	163	300 W	230 V/50 Hz	2,219 kWh											
Kühltisch 260 Liter, 4 Schubladen, GN 2/3 <ul style="list-style-type: none"> · 1360 x 600 x 860 mm · Innenmaß: 799 x 480 x 569 mm · Temperatur: -2°C/+8°C · Umluftkühlung, automatische Abtauung · 300 W, 230 V, 50 Hz, Verbrauch: 2,05 kW/24h · Rostmaß: 328 x 430 mm · Schubladenmaß: 430 x 320 mm · Verpackungsmaß: 1390 x 630 x 910 mm · Gewicht: 116 kg/126 kg 	60-2C4.01  	2.369,00														
wie oben, jedoch mit Aufkantung (100 mm) <table border="1"> <tr> <td>GN</td> <td>°C</td> <td>L/net</td> <td>⚡</td> <td>230 V/50 Hz</td> <td>24h</td> <td>auto</td> </tr> <tr> <td>2/3</td> <td>-2/+8</td> <td>149</td> <td>300 W</td> <td>230 V/50 Hz</td> <td>2,05 kWh</td> <td></td> </tr> </table>	GN	°C	L/net	⚡	230 V/50 Hz	24h	auto	2/3	-2/+8	149	300 W	230 V/50 Hz	2,05 kWh		60-2C4A.01 	2.429,00
GN	°C	L/net	⚡	230 V/50 Hz	24h	auto										
2/3	-2/+8	149	300 W	230 V/50 Hz	2,05 kWh											
Kühltisch 386 Liter, 3 Türen, GN 2/3 <ul style="list-style-type: none"> · 1795 x 600 x 860 mm · Innenmaß: 1234 x 480 x 569 mm · Temperatur: -2°C/+8°C · Umluftkühlung, automatische Abtauung · 300 W, 230 V, 50 Hz, Verbrauch: 2,25 kW/24h · Rostmaß: 328 x 430 mm · Verpackungsmaß: 1825 x 630 x 910 mm · Gewicht: 115 kg/130 kg 	60-3.01  	1.949,00														
wie oben, jedoch mit Aufkantung (100 mm) <table border="1"> <tr> <td>GN</td> <td>°C</td> <td>L/net</td> <td>⚡</td> <td>230 V/50 Hz</td> <td>24h</td> <td>auto</td> </tr> <tr> <td>2/3</td> <td>-2/+8</td> <td>289</td> <td>300 W</td> <td>230 V/50 Hz</td> <td>2,25 kWh</td> <td></td> </tr> </table>	GN	°C	L/net	⚡	230 V/50 Hz	24h	auto	2/3	-2/+8	289	300 W	230 V/50 Hz	2,25 kWh		60-3A.01 	1.999,00
GN	°C	L/net	⚡	230 V/50 Hz	24h	auto										
2/3	-2/+8	289	300 W	230 V/50 Hz	2,25 kWh											

Kühltische Serie 600

Abbildung
ähnlich!



GN
2/3

Artikel	Code	Euro
Kühltisch 386 Liter, 2 Türen, 2 Schubladen, GN 2/3 · 1795 x 600 x 860 mm · Innenmaß: 1234 x 480 x 569 mm · Temperatur: -2°C/+8°C · Umluftkühlung, automatische Abtauung · 300 W, 230 V, 50 Hz, Verbrauch: 2,38 kW/24h · Rostmaß: 328 x 430 mm · Schubladenmaß: 420 x 476 x 308 mm · Verpackungsmaß: 1825 x 630 x 910 mm · Gewicht: 123 kg/138 kg	60-3C2.01 	2.099,00
wie oben, jedoch mit Aufkantung (100 mm) 	60-3C2A.01	2.129,00
Kühltisch 386 Liter, 1 Tür, 4 Schubladen, GN 2/3 · 1795 x 600 x 860 mm · Innenmaß: 1234 x 480 x 569 mm · Temperatur: -2°C/+8°C · Umluftkühlung, automatische Abtauung · 300 W, 230 V, 50 Hz, Verbrauch: 2,41 kW/24h · Rostmaß: 328 x 430 mm · Schubladenmaß: 420 x 476 x 308 mm · Verpackungsmaß: 1825 x 630 x 910 mm · Gewicht: 131 kg/146 kg	60-3C4.01 	2.549,00
wie oben, jedoch mit Aufkantung (100 mm) 	60-3C4A.01	2.599,00
Kühltisch 386 Liter, 6 Schubladen, GN 2/3 · 1795 x 600 x 860 mm · Innenmaß: 1234 x 480 x 569 mm · Temperatur: -2°C/+8°C · Umluftkühlung, automatische Abtauung · 300 W, 230 V, 50 Hz, Verbrauch: 2,797 kW/24h · Schubladenmaß: 420 x 476 x 308 mm · Verpackungsmaß: 1825 x 630 x 910 mm · Gewicht: 131 kg/146 kg	60-3C6.01 	2.939,00
wie oben, jedoch mit Aufkantung (100 mm) 	60-3C6A.01	2.999,00
Kühltisch 511 Liter, 4 Türen, GN 2/3 · 2230 x 600 x 860 mm · Innenmaß: 1669 x 480 x 569 mm · Temperatur: -2°C/+8°C · Umluftkühlung, automatische Abtauung · 300 W, 230 V, 50 Hz, Verbrauch: 3,83 kW/24h · Rostmaß: 328 x 430 mm · Verpackungsmaß: 2260 x 630 x 910 mm · Gewicht: 142 kg/162 kg	60-4.01 	2.099,00
wie oben, jedoch mit Aufkantung (100 mm) 	60-4A.01	2.169,00

Kühltische Serie 600

Abbildung
ähnlich!

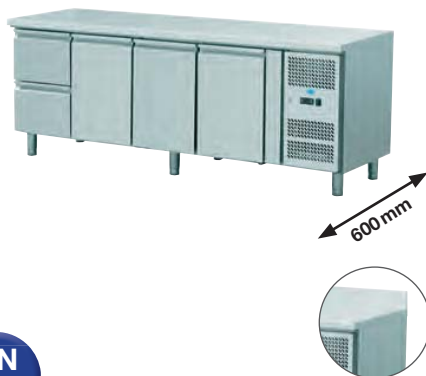

GN
2/3

Artikel	Code	Euro
Kühltisch 511 Liter, 3 Türen, 2 Schubladen, GN 2/3 · 2230 x 600 x 860 mm · Innenmaß: 1669 x 480 x 569 mm · Temperatur: -2°C/+8°C · Umluftkühlung, automatische Abtauung · 300 W, 230 V, 50 Hz, Verbrauch: 3,46 kW/24h · Rostmaß: 328 x 430 mm · Schubladenmaß: 420 x 476 x 308 mm · Verpackungsmaß: 2260 x 630 x 910 mm · Gewicht: 150 kg/170 kg wie oben, jedoch mit Aufkantung (100 mm)	60-4C2.01 	2.529,00 2.599,00

GN 2/3	°C -2/+8	L/net 373	⚡ 300 W	🔌 230 V/ 50 Hz	📊 24h 3,46 kWh	❄️ auto
-----------	-------------	--------------	------------	----------------------	----------------------	------------

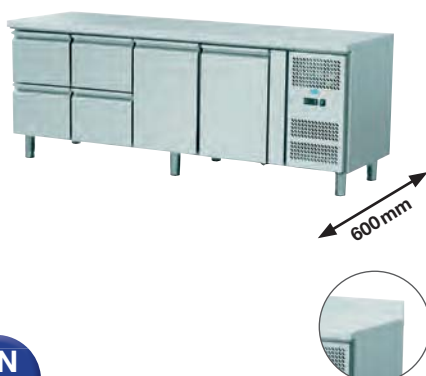

GN
2/3

Kühltisch 511 Liter, 2 Türen, 4 Schubladen, GN 2/3 · 2230 x 600 x 860 mm · Innenmaß: 1669 x 480 x 569 mm · Temperatur: -2°C/+8°C · Umluftkühlung, automatische Abtauung · 300 W, 230 V, 50 Hz, Verbrauch: 3,31 kW/24h · Rostmaß: 328 x 430 mm · Schubladenmaß: 420 x 476 x 308 mm · Verpackungsmaß: 2260 x 630 x 910 mm · Gewicht: 158 kg/178 kg wie oben, jedoch mit Aufkantung (100 mm)	60-4C4.01 	2.969,00 3.029,00
---	----------------------------------	--

GN 2/3	°C -2/+8	L/net 348	⚡ 300 W	🔌 230 V/ 50 Hz	📊 24h 3,31 kWh	❄️ auto
-----------	-------------	--------------	------------	----------------------	----------------------	------------

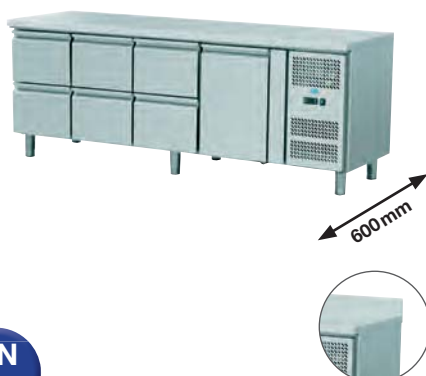

GN
2/3

Kühltisch 511 Liter, 1 Tür, 6 Schubladen, GN 2/3 · 2230 x 600 x 860 mm · Innenmaß: 1669 x 480 x 569 mm · Temperatur: -2°C/+8°C · Umluftkühlung, automatische Abtauung · 300 W, 230 V, 50 Hz, Verbrauch: 3,49 kW/24h · Rostmaß: 328 x 430 mm · Schubladenmaß: 420 x 476 x 308 mm · Verpackungsmaß: 2260 x 630 x 910 mm · Gewicht: 166 kg/186 kg wie oben, jedoch mit Aufkantung (100 mm)	60-4C6.01 	3.389,00 3.449,00
---	----------------------------------	--

GN 2/3	°C -2/+8	L/net 321	⚡ 300 W	🔌 230 V/ 50 Hz	📊 24h 3,49 kWh	❄️ auto
-----------	-------------	--------------	------------	----------------------	----------------------	------------

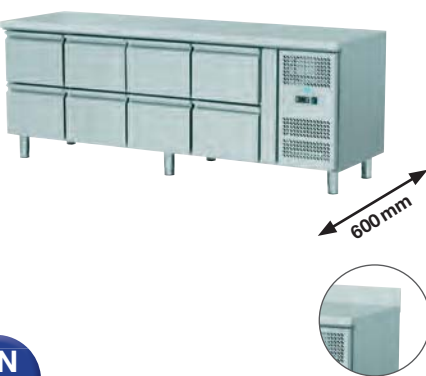





























GN
2/3

Kühltisch 511 Liter, 8 Schubladen, GN 2/3 · 2230 x 600 x 860 mm · Innenmaß: 1669 x 480 x 569 mm · Temperatur: -2°C/+8°C · Umluftkühlung, automatische Abtauung · 300 W, 230 V, 50 Hz, Verbrauch: 3,35 kW/24h · Schubladenmaß: 420 x 476 x 308 mm · Verpackungsmaß: 2260 x 630 x 910 mm · Gewicht: 174 kg/194 kg wie oben, jedoch mit Aufkantung (100 mm)	60-4C8.01 	3.749,00 3.799,00
---	----------------------------------	--

GN 2/3	°C -2/+8	L/net 297	⚡ 300 W	🔌 230 V/ 50 Hz	📊 24h 3,35 kWh	❄️ auto
-----------	-------------	--------------	------------	----------------------	----------------------	------------





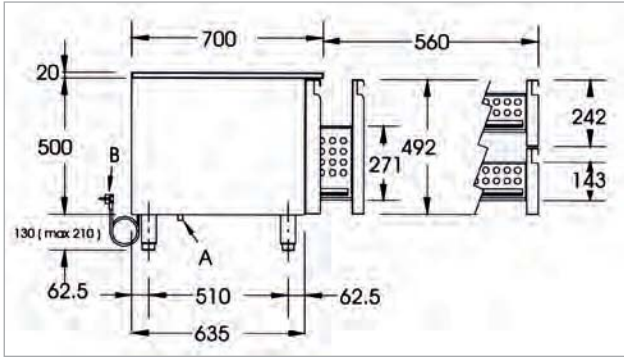









	Artikel	Code	Euro
  <p>kurze Lieferzeit</p>	Unterbaukühltsch 4 Schubladen klein - GN 1/2 1 Schublade groß - GN 1/1 · 1600 x 700 x 650 mm, 262 W, 230 V, 50 Hz · Verpackungsmaß: 1640 x 750 x 970 mm GN 1/1 / 1/2 °C +2/+8 262 W 230 V / 50 Hz kg/net 156 kg/br 181	10113202-0-0-C.01 	2.879,00 
  <p>kurze Lieferzeit</p>	Unterbaukühltsch 6 Schubladen klein - GN 1/2 · 1600 x 700 x 650 mm, 262 W, 230 V, 50 Hz · Verpackungsmaß: 1640 x 750 x 970 mm GN 1/2 °C +2/+8 262 W 230 V / 50 Hz kg/net 156 kg/br 181	10113202-0-0-E.01 	2.979,00 
  <p>kurze Lieferzeit</p>	Unterbaukühltsch 4 Schubladen groß - GN 1/1 · 2000 x 700 x 650 mm, 303 W, 230 V, 50 Hz · Verpackungsmaß: 2040 x 750 x 970 mm GN 1/1 °C +2/+8 303 W 230 V / 50 Hz kg/net 158 kg/br 193	10113203-0-0-0.01 	2.999,00 
  <p>kurze Lieferzeit</p>	Unterbaukühltsch 2 Schubladen klein - GN 1/2 3 Schubladen groß - GN 1/1 · 2000 x 700 x 650 mm, 303 W, 230 V, 50 Hz · Verpackungsmaß: 2040 x 750 x 970 mm GN 1/1 / 1/2 °C +2/+8 303 W 230 V / 50 Hz kg/net 161 kg/br 201	10113203-0-0-A.01 	3.149,00 
  <p>kurze Lieferzeit</p>	Unterbaukühltsch 4 Schubladen klein - GN 1/2 2 Schubladen groß - GN 1/1 · 2000 x 700 x 650 mm, 303 W, 230 V, 50 Hz · Verpackungsmaß: 2040 x 750 x 970 mm GN 1/1 / 1/2 °C +2/+8 303 W 230 V / 50 Hz kg/net 155 kg/br 195	10113203-0-0-C.01 	3.299,00 
  <p>kurze Lieferzeit</p>	Unterbaukühltsch 6 Schubladen klein - GN 1/2 1 Schublade groß - GN 1/1 · 2000 x 700 x 650 mm, 303 W, 230 V, 50 Hz · Verpackungsmaß: 2040 x 750 x 970 mm GN 1/1 / 1/2 °C +2/+8 303 W 230 V / 50 Hz kg/net 158 kg/br 193	10113203-0-0-E.01 	3.449,00 
  <p>kurze Lieferzeit</p>	Unterbaukühltsch 8 Schubladen klein - GN 1/2 · 2000 x 700 x 650 mm, 303 W, 230 V, 50 Hz · Verpackungsmaß: 2040 x 750 x 970 mm GN 1/2 °C +2/+8 303 W 230 V / 50 Hz kg/net 155 kg/br 193	10113203-0-0-G.01 	3.599,00 





Achtung nur Schubladen!

Allgemeine Beschreibung

- außen und innen aus Lebensmittelqualität Edelstahl
- Ventilationsverdampfer
- Abtauautomatik
- Schubladen GN 1/1 mit Teleskobschienen
- Temperatur: +2°C/+8°C

	Artikel	Code	Euro
 <p>650 mm</p>	Unterbaukühltsch 2 Schubladen - GN 1/1 · 1200 x 700 x 650 mm · Temperatur: +2°C/+8°C · 207 W, 230 V, 50 Hz · Verpackungsmaß: 1240 x 750 x 970 mm	10113201.01  	2.039,00
 <p>650 mm</p>	Unterbaukühltsch 2 Schubladen klein - GN 1/2 1 Schublade groß - GN 1/1 · 1200 x 700 x 650 mm · Temperatur: +2°C/+8°C · 207 W, 230 V, 50 Hz · Verpackungsmaß: 1240 x 750 x 970 mm	10113201A.01  	2.399,00
 <p>650 mm</p>	Unterbaukühltsch 3 Schubladen groß - GN 1/1 · 1600 x 700 x 650 mm · Temperatur: +2°C/+8°C · 262 W, 230 V, 50 Hz · Verpackungsmaß: 1640 x 750 x 970 mm	10113202.01  	2.639,00
 <p>650 mm</p>	Unterbaukühltsch 2 Schubladen klein - GN 1/2 2 Schubladen groß - GN 1/1 · 1600 x 700 x 650 mm · Temperatur: +2°C/+8°C · 262 W, 230 V, 50 Hz · Verpackungsmaß: 1640 x 750 x 970 mm	10113202A.01  	2.799,00

Unterbaukühltische

	Artikel	Code	Euro										
	Unterbaukühltisch 360 Liter <ul style="list-style-type: none"> · 2130 x 700 x 600 mm · Temperatur: -2°C/+8°C · Umluftkühlung, automatische Abtaung · 0,35 kW, 230 V, 50 Hz · 4 Schubladen GN 1/1 	UKT-3203	3.029,00										
	<table border="1"> <tr> <td>GN</td> <td>°C</td> <td>⚡</td> <td>🔌</td> <td>📦</td> </tr> <tr> <td>1/1</td> <td>-2/+8</td> <td>230 W</td> <td>230 V / 50 Hz</td> <td>165 kg/net</td> </tr> </table>	GN	°C	⚡	🔌	📦	1/1	-2/+8	230 W	230 V / 50 Hz	165 kg/net		
GN	°C	⚡	🔌	📦									
1/1	-2/+8	230 W	230 V / 50 Hz	165 kg/net									
	Unterbaukühltisch 360 Liter <ul style="list-style-type: none"> · 2130 x 700 x 600 mm · Temperatur: -2°C/+8°C · Umluftkühlung, automatische Abtaung · 0,35 kW, 230 V, 50 Hz · 3 Schubladen GN 1/1, 2 Schubladen GN 1/2 	UKT-3203AA	3.069,00										
	<table border="1"> <tr> <td>GN</td> <td>°C</td> <td>⚡</td> <td>🔌</td> <td>📦</td> </tr> <tr> <td>1/1 1/2</td> <td>-2/+8</td> <td>350 W</td> <td>230 V / 50 Hz</td> <td>165 kg/net</td> </tr> </table>	GN	°C	⚡	🔌	📦	1/1 1/2	-2/+8	350 W	230 V / 50 Hz	165 kg/net		
GN	°C	⚡	🔌	📦									
1/1 1/2	-2/+8	350 W	230 V / 50 Hz	165 kg/net									
	Unterbaukühltisch 280 Liter <ul style="list-style-type: none"> · 2130 x 700 x 600 mm · Temperatur: -2°C/+8°C · Umluftkühlung, automatische Abtaung · 0,23 kW, 230 V, 50 Hz · 2 Schubladen GN 1/1, 4 Schubladen GN 1/2 	UKT-3203CC	3.099,00										
	<table border="1"> <tr> <td>GN</td> <td>°C</td> <td>⚡</td> <td>🔌</td> <td>📦</td> </tr> <tr> <td>1/1 1/2</td> <td>-2/+8</td> <td>350 W</td> <td>230 V / 50 Hz</td> <td>165 kg/net</td> </tr> </table>	GN	°C	⚡	🔌	📦	1/1 1/2	-2/+8	350 W	230 V / 50 Hz	165 kg/net		
GN	°C	⚡	🔌	📦									
1/1 1/2	-2/+8	350 W	230 V / 50 Hz	165 kg/net									
	Unterbaukühltisch 360 Liter <ul style="list-style-type: none"> · 2130 x 700 x 600 mm · Temperatur: -2°C/+8°C · Umluftkühlung, automatische Abtaung · 0,23 kW, 230 V, 50 Hz · 1 Schublade GN 1/1, 6 Schubladen GN 1/2 	UKT-3203EE	3.149,00										
	<table border="1"> <tr> <td>GN</td> <td>°C</td> <td>⚡</td> <td>🔌</td> <td>📦</td> </tr> <tr> <td>1/1 1/2</td> <td>-2/+8</td> <td>350 W</td> <td>230 V / 50 Hz</td> <td>165 kg/net</td> </tr> </table>	GN	°C	⚡	🔌	📦	1/1 1/2	-2/+8	350 W	230 V / 50 Hz	165 kg/net		
GN	°C	⚡	🔌	📦									
1/1 1/2	-2/+8	350 W	230 V / 50 Hz	165 kg/net									
	Unterbaukühltisch 360 Liter <ul style="list-style-type: none"> · 1200 x 700 x 600 mm · Temperatur: -2°C/+8°C · Umluftkühlung, automatische Abtaung · 0,23 kW, 230 V, 50 Hz · 8 Schubladen GN 1/2 	UKT-3203GG	3.179,00										
	<table border="1"> <tr> <td>GN</td> <td>°C</td> <td>⚡</td> <td>🔌</td> <td>📦</td> </tr> <tr> <td>1/2</td> <td>-2/+8</td> <td>350 W</td> <td>230 V / 50 Hz</td> <td>165 kg/net</td> </tr> </table>	GN	°C	⚡	🔌	📦	1/2	-2/+8	350 W	230 V / 50 Hz	165 kg/net		
GN	°C	⚡	🔌	📦									
1/2	-2/+8	350 W	230 V / 50 Hz	165 kg/net									



Unterbaukühlische

	Artikel	Code	Euro
	Unterbaukühlisch 180 Liter · 1200 x 700 x 600 mm · Temperatur: -2°C/+8°C · Umluftkühlung, automatische Abtauung · 0,17 kW, 230 V, 50 Hz · 2 Schubladen GN 1/1	UKT-3201	1.999,00
	GN 1/1 °C -2/+8 ⚡ 170 W 230 V / 50 Hz kg/met 112		
	Unterbaukühlisch 180 Liter · 1200 x 700 x 600 mm · Temperatur: -2°C/+8°C · Umluftkühlung, automatische Abtauung · 0,17 kW, 230 V, 50 Hz · 1 Schublade GN 1/1, 2 Schubladen GN 1/2	UKT-3201AA	2.049,00
	GN 1/1 1/2 °C -2/+8 ⚡ 170 W 230 V / 50 Hz kg/met 112		
	Unterbaukühlisch 280 Liter · 1600 x 700 x 600 mm · Temperatur: -2°C/+8°C · Umluftkühlung, automatische Abtauung · 0,23 kW, 230 V, 50 Hz · 3 Schubladen GN 1/1	UKT-3202	2.459,00
	GN 1/1 °C -2/+8 ⚡ 230 W 230 V / 50 Hz kg/met 145		
	Unterbaukühlisch 280 Liter · 1600 x 700 x 600 mm · Temperatur: -2°C/+8°C · Umluftkühlung, automatische Abtauung · 0,23 kW, 230 V, 50 Hz · 2 Schubladen GN 1/1, 2 Schubladen GN 1/2	UKT-3202AA	2.499,00
	GN 1/1 1/2 °C -2/+8 ⚡ 230 W 230 V / 50 Hz kg/met 145		
	Unterbaukühlisch 280 Liter · 1600 x 700 x 600 mm · Temperatur: -2°C/+8°C · Umluftkühlung, automatische Abtauung · 0,23 kW, 230 V, 50 Hz · 1 Schubladen GN 1/1, 4 Schubladen GN 1/2	UKT-3202CC	2.529,00
	GN 1/1 1/2 °C -2/+8 ⚡ 230 W 230 V / 50 Hz kg/met 145		
	Unterbaukühlisch 280 Liter · 1600 x 700 x 600 mm · Temperatur: -2°C/+8°C · Umluftkühlung, automatische Abtauung · 0,23 kW, 230 V, 50 Hz · 6 Schubladen GN 1/2	UKT-3202EE	2.579,00
	GN 1/2 °C -2/+8 ⚡ 230 W 230 V / 50 Hz kg/met 145		



Kühltische Serie 700

Abbildung
ähnlich!





Artikel	Code	Euro																								
Kühltisch 2 Schubladen · 925 x 700 x 860 mm · Innenmaß: 364 x 580 x 560 mm · Temperatur: -2°C/+8°C · Umluftkühlung, automatische Abtauung · 300 W, 230 V, 50 Hz · Verbrauch: 1,75 kW/24h · LED-Beleuchtung · Edelstahl · Schubladen 420x576x307 mm · Verpackungsmaß: 950 x 730 x 910 mm	GN1120 TN.01NS  	1.799,00																								
<table border="1"> <tr> <td>°C</td> <td>L/net</td> <td>⚡</td> <td>🔌</td> <td>📊</td> <td>🔄</td> <td>📦</td> <td>📦</td> </tr> <tr> <td>-2/+8</td> <td>59</td> <td>300 W</td> <td>230 V / 50 Hz</td> <td>1,75 kWh</td> <td>24h</td> <td>kg/net</td> <td>kg/br</td> </tr> <tr> <td></td> <td></td> <td></td> <td></td> <td></td> <td></td> <td>94</td> <td>104</td> </tr> </table>	°C	L/net	⚡	🔌	📊	🔄	📦	📦	-2/+8	59	300 W	230 V / 50 Hz	1,75 kWh	24h	kg/net	kg/br							94	104		
°C	L/net	⚡	🔌	📊	🔄	📦	📦																			
-2/+8	59	300 W	230 V / 50 Hz	1,75 kWh	24h	kg/net	kg/br																			
						94	104																			





Kühltisch 3 Schubladen · 925 x 700 x 860 mm · Innenmaß: 364 x 580 x 560 mm · Temperatur: -2°C/+8°C · Umluftkühlung, automatische Abtauung · 300 W, 230 V, 50 Hz · Verbrauch: 1,82 kW/24h · LED-Beleuchtung · Edelstahl · Schubladen 420 x 576 x 200 mm · Verpackungsmaß: 950 x 730 x 910 mm	GN1130 TN.01NS  	1.929,00																								
<table border="1"> <tr> <td>°C</td> <td>L/net</td> <td>⚡</td> <td>🔌</td> <td>📊</td> <td>🔄</td> <td>📦</td> <td>📦</td> </tr> <tr> <td>-2/+8</td> <td>59</td> <td>300 W</td> <td>230 V / 50 Hz</td> <td>1,82 kWh</td> <td>24h</td> <td>kg/net</td> <td>kg/br</td> </tr> <tr> <td></td> <td></td> <td></td> <td></td> <td></td> <td></td> <td>72</td> <td>81</td> </tr> </table>	°C	L/net	⚡	🔌	📊	🔄	📦	📦	-2/+8	59	300 W	230 V / 50 Hz	1,82 kWh	24h	kg/net	kg/br							72	81		
°C	L/net	⚡	🔌	📊	🔄	📦	📦																			
-2/+8	59	300 W	230 V / 50 Hz	1,82 kWh	24h	kg/net	kg/br																			
						72	81																			



Kühltisch 314 Liter, 2 Türen, GN 1/1 · 1360 x 700 x 860 mm · Innenmaß: 799 x 580 x 569 mm · Temperatur: -2°C/+8°C · Umluftkühlung, automatische Abtauung · 300 W, 230 V, 50 Hz · Verbrauch: 2,55 kW/24h · Rostmaß: 328 x 530 mm	VIP-2.01  	1.759,00																								
wie oben, jedoch mit Aufkantung (100 mm)	VIP-2A.01	1.819,00																								
<table border="1"> <tr> <td>°C</td> <td>L/net</td> <td>⚡</td> <td>🔌</td> <td>📊</td> <td>🔄</td> <td>📦</td> <td>📦</td> </tr> <tr> <td>-2/+8</td> <td>205</td> <td>300 W</td> <td>230 V / 50 Hz</td> <td>2,55 kWh</td> <td>24h</td> <td>kg/net</td> <td>kg/br</td> </tr> <tr> <td></td> <td></td> <td></td> <td></td> <td></td> <td></td> <td>108</td> <td>118</td> </tr> </table>	°C	L/net	⚡	🔌	📊	🔄	📦	📦	-2/+8	205	300 W	230 V / 50 Hz	2,55 kWh	24h	kg/net	kg/br							108	118		
°C	L/net	⚡	🔌	📊	🔄	📦	📦																			
-2/+8	205	300 W	230 V / 50 Hz	2,55 kWh	24h	kg/net	kg/br																			
						108	118																			

GN
1/1



Kühltisch 314 Liter, 1 Tür, 2 Schubladen, GN 1/1 · 1360 x 700 x 860 mm · Innenmaß: 799 x 580 x 569 mm · Temperatur: -2°C/+8°C · Umluftkühlung, automatische Abtauung · 300 W, 230 V, 50 Hz · Verbrauch: 2,67 kW/24h · Schubladenmaß: 420 x 576 x 308 mm	VIP-2C2.01  	2.279,00																								
wie oben, jedoch mit Aufkantung (100 mm)	VIP-2C2A.01	2.339,00																								
<table border="1"> <tr> <td>°C</td> <td>L/net</td> <td>⚡</td> <td>🔌</td> <td>📊</td> <td>🔄</td> <td>📦</td> <td>📦</td> </tr> <tr> <td>-2/+8</td> <td>171</td> <td>300 W</td> <td>230 V / 50 Hz</td> <td>2,67 kWh</td> <td>24h</td> <td>kg/net</td> <td>kg/br</td> </tr> <tr> <td></td> <td></td> <td></td> <td></td> <td></td> <td></td> <td>116</td> <td>126</td> </tr> </table>	°C	L/net	⚡	🔌	📊	🔄	📦	📦	-2/+8	171	300 W	230 V / 50 Hz	2,67 kWh	24h	kg/net	kg/br							116	126		
°C	L/net	⚡	🔌	📊	🔄	📦	📦																			
-2/+8	171	300 W	230 V / 50 Hz	2,67 kWh	24h	kg/net	kg/br																			
						116	126																			

GN
1/1



Kühltische Serie 700

Abbildung
ähnlich!



GN
1/1



Artikel	Code	Euro																
Kühltisch 314 Liter, 4 Schubladen, GN 1/1 · 1360 x 700 x 860 mm · Temperatur: -2°C/+8°C · Umluftkühlung, automatische Abtauung · 350 W, 230 V, 50 Hz · Verbrauch: 2 kW/24h	VIP-2C4.01	2.639,00																
wie oben, jedoch mit Aufkantung (100 mm)	VIP-2C4A.01	2.699,00																
<table border="1"> <tr> <td>°C</td> <td>L/net</td> <td>⚡</td> <td>230 V/50 Hz</td> <td>24h</td> <td>auto</td> <td>kg/net</td> <td>kg/br</td> </tr> <tr> <td>-2/+8</td> <td>118</td> <td>350 W</td> <td>230 V/50 Hz</td> <td>2 kWh</td> <td></td> <td>124</td> <td>134</td> </tr> </table>			°C	L/net	⚡	230 V/50 Hz	24h	auto	kg/net	kg/br	-2/+8	118	350 W	230 V/50 Hz	2 kWh		124	134
°C	L/net	⚡	230 V/50 Hz	24h	auto	kg/net	kg/br											
-2/+8	118	350 W	230 V/50 Hz	2 kWh		124	134											



GN
1/1



Kühltisch 313,5 Liter, 6 Schubladen, GN 1/1 · 1360 x 700 x 860 mm · Temperatur: -2°C/+8°C · Umluftkühlung, automatische Abtauung · 350 W, 230 V, 50 Hz · Verbrauch: 2,86 kW/24h	VIP-2C6.01	2.999,00																
wie oben, jedoch mit Aufkantung (100 mm)	VIP-2C6A.01	3.039,00																
<table border="1"> <tr> <td>°C</td> <td>L/net</td> <td>⚡</td> <td>230 V/50 Hz</td> <td>24h</td> <td>auto</td> <td>kg/net</td> <td>kg/br</td> </tr> <tr> <td>-2/+8</td> <td>118</td> <td>350 W</td> <td>230 V/50 Hz</td> <td>2,86 kWh</td> <td></td> <td>134</td> <td>144</td> </tr> </table>			°C	L/net	⚡	230 V/50 Hz	24h	auto	kg/net	kg/br	-2/+8	118	350 W	230 V/50 Hz	2,86 kWh		134	144
°C	L/net	⚡	230 V/50 Hz	24h	auto	kg/net	kg/br											
-2/+8	118	350 W	230 V/50 Hz	2,86 kWh		134	144											



GN
1/1



Kühltisch 464 Liter, 3 Türen, GN 1/1 · 1795 x 700 x 860 mm · GN 1/1 · Temperatur: -2°C/+8°C · Umluftkühlung, automatische Abtauung · 350 W, 230 V, 50 Hz · Verbrauch: 2,45 kW/24h	VIP-3.01	1.969,00																
wie oben, jedoch mit Aufkantung (100 mm)	VIP-3A.01	2.019,00																
<table border="1"> <tr> <td>°C</td> <td>L/net</td> <td>⚡</td> <td>230 V/50 Hz</td> <td>24h</td> <td>auto</td> <td>kg/net</td> <td>kg/br</td> </tr> <tr> <td>-2/+8</td> <td>358</td> <td>350 W</td> <td>230 V/50 Hz</td> <td>2,45 kWh</td> <td></td> <td>125</td> <td>140</td> </tr> </table>			°C	L/net	⚡	230 V/50 Hz	24h	auto	kg/net	kg/br	-2/+8	358	350 W	230 V/50 Hz	2,45 kWh		125	140
°C	L/net	⚡	230 V/50 Hz	24h	auto	kg/net	kg/br											
-2/+8	358	350 W	230 V/50 Hz	2,45 kWh		125	140											



GN
1/1



Kühltisch 464 Liter, 2 Türen, 2 Schubladen, GN 1/1 · 1795 x 700 x 860 mm · GN 1/1 · Temperatur: -2°C/+8°C · Umluftkühlung, automatische Abtauung · 350 W, 230 V, 50 Hz · Verbrauch: 2,3 kW/24h	VIP-3C2.01	2.429,00																
wie oben, jedoch mit Aufkantung (100 mm)	VIP-3C2A.01	2.459,00																
<table border="1"> <tr> <td>°C</td> <td>L/net</td> <td>⚡</td> <td>230 V/50 Hz</td> <td>24h</td> <td>auto</td> <td>kg/net</td> <td>kg/br</td> </tr> <tr> <td>-2/+8</td> <td>284</td> <td>350 W</td> <td>230 V/50 Hz</td> <td>2,3 kWh</td> <td></td> <td>133</td> <td>148</td> </tr> </table>			°C	L/net	⚡	230 V/50 Hz	24h	auto	kg/net	kg/br	-2/+8	284	350 W	230 V/50 Hz	2,3 kWh		133	148
°C	L/net	⚡	230 V/50 Hz	24h	auto	kg/net	kg/br											
-2/+8	284	350 W	230 V/50 Hz	2,3 kWh		133	148											



Kühltische Serie 700

Abbildung
ähnlich!



GN
1/1



Kühltisch

464 Liter, 1 Tür, 4 Schubladen, GN 1/1

- 1795 x 700 x 860 mm
- GN 1/1
- Temperatur: -2°C/+8°C
- Umluftkühlung, automatische Abtauung
- 350 W, 230 V, 50 Hz
- Verbrauch: 3,18 kW/24h

wie oben, jedoch mit Aufkantung (100 mm)

°C	L/net	⚡	🔌	📊	🔄	🧴	🧴
-2/+8	230	350 W	230 V / 50 Hz	3,18 kWh	auto	141 kg/net	156 kg/br

Code

VIP-3C4.01

Euro

2.899,00

B



VIP-3C4A.01

2.929,00

C



VIP-3C6A.01

3.199,00

C



VIP-3C9A.01

3.599,00

C



VIP-4A.01

2.369,00



GN
1/1



Kühltisch

464 Liter, 6 Schubladen, GN 1/1

- 1795 x 700 x 860 mm
- GN 1/1
- Temperatur: -2°C/+8°C
- Umluftkühlung, automatische Abtauung
- 350 W, 230 V, 50 Hz
- Verbrauch: 2,64 kW/24h

wie oben, jedoch mit Aufkantung (100 mm)

°C	L/net	⚡	🔌	📊	🔄	🧴	🧴
-2/+8	275	350 W	230 V / 50 Hz	2,64 kWh	auto	149 kg/net	164 kg/br

VIP-3C6.01

3.139,00



GN
1/1

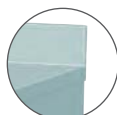

Kühltisch

464 Liter, 9 Schubladen, GN 1/1

- 1795 x 700 x 860 mm
- GN 1/1
- Temperatur: -2°C/+8°C
- Umluftkühlung, automatische Abtauung
- 350 W, 230 V, 50 Hz
- Verbrauch: 2,96 kW/24h

wie oben, jedoch mit Aufkantung (100 mm)

°C	L/net	⚡	🔌	📊	🔄	🧴	🧴
-2/+8	275	350 W	230 V / 50 Hz	2,96 kWh	auto	165 kg/net	180 kg/br

VIP-3C9.01

3.479,00



GN
1/1



Kühltisch

616 Liter, 4 Türen, GN 1/1

- 2230 x 700 x 860 mm
- GN 1/1
- Temperatur: -2°C/+8°C
- Umluftkühlung, automatische Abtauung
- 350 W, 230 V, 50 Hz
- Verbrauch: 3,96 kW/24h

wie oben, jedoch mit Aufkantung (100 mm)

°C	L/net	⚡	🔌	📊	🔄	🧴	🧴
-2/+8	476	350 W	230 V / 50 Hz	3,96 kWh	auto	159 kg/net	179 kg/br

VIP-4.01

2.299,00

Kühltische Serie 700

Abbildung
ähnlich!



GN
1/1



Artikel	Code	Euro																
Kühltisch 616 Liter, 3 Türen, 2 Schubladen, GN 1/1 · 2230 x 700 x 860 mm · GN 1/1 · Temperatur: -2°C/+8°C · Umluftkühlung, automatische Abtauung · 350 W, 230 V, 50 Hz · Verbrauch: 3,4 kW/24h	VIP-4C2.01 	2.779,00																
wie oben, jedoch mit Aufkantung (100 mm)	VIP-4C2A.01	2.849,00																
<table border="1"> <tr> <td>°C</td> <td>L/net</td> <td>⚡</td> <td>230 V/50 Hz</td> <td>24h</td> <td>auto</td> <td>kg/net</td> <td>kg/br</td> </tr> <tr> <td>-2/+8</td> <td>453</td> <td>350 W</td> <td>230 V/50 Hz</td> <td>3,4 kWh</td> <td></td> <td>167</td> <td>187</td> </tr> </table>			°C	L/net	⚡	230 V/50 Hz	24h	auto	kg/net	kg/br	-2/+8	453	350 W	230 V/50 Hz	3,4 kWh		167	187
°C	L/net	⚡	230 V/50 Hz	24h	auto	kg/net	kg/br											
-2/+8	453	350 W	230 V/50 Hz	3,4 kWh		167	187											



GN
1/1



Kühltisch 616 Liter, 2 Türen, 4 Schubladen, GN 1/1 · 2230 x 700 x 860 mm · GN 1/1 · Temperatur: -2°C/+8°C · Umluftkühlung, automatische Abtauung · 350 W, 230 V, 50 Hz · Verbrauch: 3,56 kW/24h	VIP-4C4.01 	3.269,00																
wie oben, jedoch mit Aufkantung (100 mm)	VIP-4C4A.01	3.329,00																
<table border="1"> <tr> <td>°C</td> <td>L/net</td> <td>⚡</td> <td>230 V/50 Hz</td> <td>24h</td> <td>auto</td> <td>kg/net</td> <td>kg/br</td> </tr> <tr> <td>-2/+8</td> <td>343</td> <td>350 W</td> <td>230 V/50 Hz</td> <td>3,56 kWh</td> <td></td> <td>175</td> <td>195</td> </tr> </table>			°C	L/net	⚡	230 V/50 Hz	24h	auto	kg/net	kg/br	-2/+8	343	350 W	230 V/50 Hz	3,56 kWh		175	195
°C	L/net	⚡	230 V/50 Hz	24h	auto	kg/net	kg/br											
-2/+8	343	350 W	230 V/50 Hz	3,56 kWh		175	195											



GN
1/1



Kühltisch 616 Liter, 1 Tür, 6 Schubladen, GN 1/1 · 2230 x 700 x 860 mm · GN 1/1 · Temperatur: -2°C/+8°C · Umluftkühlung, automatische Abtauung · 350 W, 230 V, 50 Hz · Verbrauch: 3,62 kW/24h	VIP-4C6.01 	3.749,00																
wie oben, jedoch mit Aufkantung (100 mm)	VIP-4C6A.01	3.799,00																
<table border="1"> <tr> <td>°C</td> <td>L/net</td> <td>⚡</td> <td>230 V/50 Hz</td> <td>24h</td> <td>auto</td> <td>kg/net</td> <td>kg/br</td> </tr> <tr> <td>-2/+8</td> <td>343</td> <td>350 W</td> <td>230 V/50 Hz</td> <td>3,62 kWh</td> <td></td> <td>183</td> <td>203</td> </tr> </table>			°C	L/net	⚡	230 V/50 Hz	24h	auto	kg/net	kg/br	-2/+8	343	350 W	230 V/50 Hz	3,62 kWh		183	203
°C	L/net	⚡	230 V/50 Hz	24h	auto	kg/net	kg/br											
-2/+8	343	350 W	230 V/50 Hz	3,62 kWh		183	203											



GN
1/1



Kühltisch 616 Liter, 8 Schubladen, GN 1/1 · 2230 x 700 x 860 mm · GN 1/1 · Temperatur: -2°C/+8°C · Umluftkühlung, automatische Abtauung · 350 W, 230 V, 50 Hz · Verbrauch: 3,7 kW/24h	VIP-4C8.01 	4.129,00																
wie oben, jedoch mit Aufkantung (100 mm)	VIP-4C8A.01	4.169,00																
<table border="1"> <tr> <td>°C</td> <td>L/net</td> <td>⚡</td> <td>230 V/50 Hz</td> <td>24h</td> <td>auto</td> <td>kg/net</td> <td>kg/br</td> </tr> <tr> <td>-2/+8</td> <td>366</td> <td>350 W</td> <td>230 V/50 Hz</td> <td>3,7 kWh</td> <td></td> <td>196</td> <td>211</td> </tr> </table>			°C	L/net	⚡	230 V/50 Hz	24h	auto	kg/net	kg/br	-2/+8	366	350 W	230 V/50 Hz	3,7 kWh		196	211
°C	L/net	⚡	230 V/50 Hz	24h	auto	kg/net	kg/br											
-2/+8	366	350 W	230 V/50 Hz	3,7 kWh		196	211											

Mini Kühltische 700

	Artikel	Code	Euro															
	Kühltisch 109 Liter, 1 Tür · 435 x 700 x 870 mm · Innenmaß: 362 x 595 x 456 mm · Temperatur: +2°C/+8°C, automatische Abtauung · statisch Kühlung mit Zwangsumwälzung · 100 W, 230 V, 50 Hz, Verbrauch: 1,85 kW/24 h · Rostmaß: 328 x 530 mm · Verpackungsmaß: 510 x 760 x 1060 mm 2 Schubladen	S401.01 	759,00 999,00															
	<table border="1"> <tr> <td>°C</td> <td>L/net</td> <td>⚡</td> <td>🔌</td> <td>🕒</td> <td>❄️</td> <td>📊</td> <td>📊</td> </tr> <tr> <td>+2/+8</td> <td>65/88</td> <td>100 W</td> <td>230 V / 50 Hz</td> <td>1,85 kWh</td> <td>auto</td> <td>kg/net 48</td> <td>kg/br 55</td> </tr> </table>	°C	L/net	⚡	🔌	🕒	❄️	📊	📊	+2/+8	65/88	100 W	230 V / 50 Hz	1,85 kWh	auto	kg/net 48	kg/br 55	
°C	L/net	⚡	🔌	🕒	❄️	📊	📊											
+2/+8	65/88	100 W	230 V / 50 Hz	1,85 kWh	auto	kg/net 48	kg/br 55											
	Kühltisch 257 Liter, 2 Türen · Innenmaß: 830 x 595 x 456 mm · Temperatur: +2°C/+8°C · statische Kühlung mit Zwangsumwälzung · 155 W, 230 V, 50 Hz · Verbrauch: 2,56 kW/24h · automatische Abtauung, digitale Steuerung · inkl. 2 Einlegeböden: 328 x 530 mm ohne Aufkantung · 903 x 700 x 870 mm mit Aufkantung · 903 x 700 x 910 mm	 	920,00 1.149,00															
	<table border="1"> <tr> <td>°C</td> <td>L/net</td> <td>⚡</td> <td>🔌</td> <td>🕒</td> <td>❄️</td> <td>📊</td> <td>📊</td> </tr> <tr> <td>+2/+8</td> <td>201</td> <td>155 W</td> <td>230 V / 50 Hz</td> <td>2,56 kWh</td> <td>auto</td> <td>kg/net 72</td> <td>kg/br 83</td> </tr> </table>	°C	L/net	⚡	🔌	🕒	❄️	📊	📊	+2/+8	201	155 W	230 V / 50 Hz	2,56 kWh	auto	kg/net 72	kg/br 83	
°C	L/net	⚡	🔌	🕒	❄️	📊	📊											
+2/+8	201	155 W	230 V / 50 Hz	2,56 kWh	auto	kg/net 72	kg/br 83											
	Kühltisch 257 Liter, 1 Tür, 2 Schubladen · Innenmaß: 830 x 595 x 456 mm · Temperatur: +2°C/+8°C · statische Kühlung mit Zwangsumwälzung · 155 W, 230 V, 50 Hz, Verbrauch: 2,42 kW/24h · automatische Abtauung, digitale Temperaturkontrolle · Schublade: 428 x 576 x 260 mm · inkl. 1 Einlegeboden: 328 x 530 mm ohne Aufkantung · 903 x 700 x 850 mm mit Aufkantung · 903 x 700 x 910 mm	 	1.250,00 1.389,00															
	<table border="1"> <tr> <td>°C</td> <td>L/net</td> <td>⚡</td> <td>🔌</td> <td>🕒</td> <td>❄️</td> <td>📊</td> <td>📊</td> </tr> <tr> <td>+2/+8</td> <td>161</td> <td>155 W</td> <td>230 V / 50 Hz</td> <td>2,42 kWh</td> <td>auto</td> <td>kg/net 81</td> <td>kg/br 91</td> </tr> </table>	°C	L/net	⚡	🔌	🕒	❄️	📊	📊	+2/+8	161	155 W	230 V / 50 Hz	2,42 kWh	auto	kg/net 81	kg/br 91	
°C	L/net	⚡	🔌	🕒	❄️	📊	📊											
+2/+8	161	155 W	230 V / 50 Hz	2,42 kWh	auto	kg/net 81	kg/br 91											
	Kühltisch 257 Liter, 4 Schubladen · Innenmaß: 830 x 595 x 456 mm · Temperatur: +2°C/+8°C · statische Kühlung mit Zwangsumwälzung · 155 W, 230 V, 50 Hz, Verbrauch: 2,25 kW/24h · automatische Abtauung, digitale Steuerung · Schublade: 428 x 576 x 260 mm · inkl. 2 Einlegeböden: 328 x 530 mm ohne Aufkantung · 903 x 700 x 870 mm mit Aufkantung · 903 x 700 x 910 mm	 	1.529,00 1.729,00															
	<table border="1"> <tr> <td>°C</td> <td>L/net</td> <td>⚡</td> <td>🔌</td> <td>🕒</td> <td>❄️</td> <td>📊</td> <td>📊</td> </tr> <tr> <td>+2/+8</td> <td>130</td> <td>155 W</td> <td>230 V / 50 Hz</td> <td>2,25 kWh</td> <td>auto</td> <td>kg/net 89</td> <td>kg/br 99</td> </tr> </table>	°C	L/net	⚡	🔌	🕒	❄️	📊	📊	+2/+8	130	155 W	230 V / 50 Hz	2,25 kWh	auto	kg/net 89	kg/br 99	
°C	L/net	⚡	🔌	🕒	❄️	📊	📊											
+2/+8	130	155 W	230 V / 50 Hz	2,25 kWh	auto	kg/net 89	kg/br 99											

Mini Kühltische 700









	Artikel	Code	Euro
	Kühltisch 400 Liter, 3 Türen <ul style="list-style-type: none"> · Innenmaß: 1295 x 595 x 456 mm · Temperatur: +2°C/+8°C · statische Kühlung mit Zwangsumwälzung · 235 W, 230 V, 50 Hz, Verbrauch: 3,15 kW/24h · automatische Abtauung, digitale Steuerung · inkl. 3 Einlegeböden: 328 x 530 mm 	  K1365.01 KSA-1365.01	 1.519,00 1.539,00
	ohne Aufkantung · 1365 x 700 x 870 mm mit Aufkantung · 1365 x 700 x 910 mm		
			
	Kühltisch 400 Liter, 2 Türen, 2 Schubladen <ul style="list-style-type: none"> · Innenmaß: 1295 x 595 x 456 mm · Temperatur: +2°C/+8°C · statische Kühlung mit Zwangsumwälzung · 235 W, 230 V, 50 Hz, Verbrauch: 3,18 kW/24h · automatische Abtauung, digitale Steuerung · Schubladenmaß: 428 x 576 x 260 mm · inkl. 2 Einlegeböden: 328 x 530 mm 	  S93C2.01 KSA-93C2.01	 1.829,00 1.829,00
	ohne Aufkantung · 1365 x 700 x 870 mm mit Aufkantung · 1365 x 700 x 910 mm		
			
	Kühltisch 400 Liter, 1 Tür, 4 Schubladen <ul style="list-style-type: none"> · Innenmaß: 1295 x 595 x 456 mm · Temperatur: +2°C/+8°C · statische Kühlung mit Zwangsumwälzung · 235 W, 230 V, 50 Hz, Verbrauch: 3,2 kW/24h · automatische Abtauung, digitale Steuerung · Schubladenmaß: 428 x 576 x 260 mm · inkl. 2 Einlegeböden: 328 x 530 mm 	  S93C4.01 KSA-93C4	 2.099,00 2.099,00
	ohne Aufkantung · 1365 x 700 x 870 mm mit Aufkantung · 1365 x 700 x 910 mm		
			
	Kühltisch 400 Liter, 6 Schubladen, mit Aufkantung <ul style="list-style-type: none"> · Innenmaß: 1295 x 595 x 456 mm · Temperatur: +2°C/+8°C · statische Kühlung mit Zwangsumwälzung · 235 W, 230 V, 50 Hz, Verbrauch: 3,04 kW/24h · automatische Abtauung, digitale Steuerung · Schubladenmaß: 428 x 576 x 260 mm 	  S93C6.01 KSA-93C6.01	 2.529,00 2.529,00
	ohne Aufkantung · 1365 x 700 x 870 mm mit Aufkantung · 1365 x 700 x 910 mm		
			



Bäckerei- & Konditorei Kühlschränke

	Artikel	Code	Euro
	<p>Kühltisch mit Granitplatte</p> <ul style="list-style-type: none"> · Temperatur: +2°C/+8°C · manuelle Abtauung · Rostmaß: 328 x 530 mm <p>257 Liter</p> <ul style="list-style-type: none"> · 900 x 700 x 870 mm · 155 W, 230 V, 50 Hz · Verbrauch: 2,56 kW/24h · Gewicht: 182 kg/192 kg <p>400 Liter</p> <ul style="list-style-type: none"> · 1365 x 700 x 870 mm · 230 W, 230 V, 50 Hz · Verbrauch: 3,05 kW/24h · Gewicht: 195 kg/210 kg 	<p>C</p> <p>SG901.01</p> <p>Kältemittel: R600a</p> <p>SG903.01NS</p>	<p>1.099,00</p> <p>1.619,00</p>
<p>BN 60x40</p> 	<p>Konditorei Kühltisch 240 Liter (netto), 3 Türen</p> <ul style="list-style-type: none"> · 1470 x 720 x 850 mm · Temperatur: 0°C/+8°C · statische Kühlung · 230 W, 230 V, 50 Hz · Verbrauch: 1,45 kW/24h · Türen mit Automatikverschluss · 7 Paar Schienen je Tür · mit Edelstahl Arbeitsplatte · 2 Türen für Bleche 400 x 600 mm · Verpackungsmaß: 1510 x 760 x 1100 mm <p>mit Granit Arbeitsplatte</p>	<p>10103201.01</p> <p>B</p> <p>Kältemittel: R290</p> <p>1010320 1G.01</p>	<p>2.469,00</p> <p>2.694,00</p>
<p>BN 60x40</p> 	<p>Konditorei Kühltisch 360 Liter (netto), 3 Türen</p> <ul style="list-style-type: none"> · 1980 x 720 x 850 mm · Temperatur: 0°C/+8°C · statische Kühlung · 276 W, 230 V, 50 Hz · Türen mit Automatikverschluss · 7 Paar Schienen je Tür · mit Edelstahl Arbeitsplatte · 3 Türen für Bleche 400 x 600 mm <p>mit Granit Arbeitsplatte</p>	<p>10103202.01</p> <p>B</p> <p>Kältemittel: R290</p> <p>1010320 2G.01</p>	<p>3.129,00</p> <p>3.659,00</p>
<p>BN 60x40</p> 	<p>Konditorei Kühltisch 480 Liter (netto), 4 Türen</p> <ul style="list-style-type: none"> · 2490 x 720 x 850 mm · Temperatur: 0°C/+8°C · statische Kühlung · 386 W, 230 V, 50 Hz · Türen mit Automatikverschluss · 7 Paar Schienen je Tür · mit Edelstahl Arbeitsplatte · 4 Türen für Bleche 400 x 600 mm <p>mit Granit Arbeitsplatte</p>	<p>10103203.01</p> <p>B</p> <p>Kältemittel: R290</p> <p>1010320 3G.01</p>	<p>3.799,00</p> <p>4.519,00</p>

Kühltische & Bäckereikühltische

	Artikel	Code	Euro
 <p>60x40</p>	<p>Kühltisch ohne Arbeitsplatte, mit Isolierplatte</p> <p>440 Liter, 2 Türen</p> <ul style="list-style-type: none"> · 1600 x 800 x 850/920 mm · Temperatur: 0°C/+10°C · 495 W, 230 V, 50 Hz · Aggregatblock rechts · aus Edelstahl · Rost: 600 x 400 mm 	<p>BACISO2</p> 	<p>2.299,00</p>
	<p>°C 0/+10</p> <p>⚡ 495 W</p> <p>🔌 230 V / 50 Hz</p> <p>📦 kg/net 84</p> <p>📦 kg/br 107</p>		
 	<p>Bäckereikühltisch</p> <p>680 Liter, 3 Türen, ohne Aufkantung</p> <ul style="list-style-type: none"> · 2150 x 800 x 850/920 mm · Temperatur: 0°C/+10°C · 495 W, 230 V, 50 Hz · Verbrauch: 4,05 kW/24h, Aggregatblock rechts · Türmaß: 600 x 400 mm 	<p>BACK3</p> 	<p>2.649,00</p>
<p>BN 60x40</p>	<p>mit Aufkantung (100 mm)</p>	<p>BACK3A</p>	<p>2.829,00</p>
	<p>°C 0/+10</p> <p>L/net 432</p> <p>⚡ 495 W</p> <p>🔌 230 V / 50 Hz</p> <p>📊 24h 4,05 kWh</p> <p>📦 kg/net 116</p> <p>📦 kg/br 145</p>		
 	<p>Bäckereikühltisch</p> <p>890 Liter, 4 Türen, ohne Aufkantung</p> <ul style="list-style-type: none"> · 2700 x 800 x 850/920 mm · Temperatur: 0°C/+10°C · 495 W, 230 V, 50 Hz · Verbrauch: 4,58 kW/24h, Aggregatblock recht · Türmaß: 600 x 400 mm 	<p>BACK4</p> 	<p>3.129,00</p>
<p>BN 60x40</p>	<p>mit Aufkantung (100 mm)</p>	<p>BACK4A</p>	<p>3.329,00</p>
	<p>°C 0/+10</p> <p>L/net 576</p> <p>⚡ 495 W</p> <p>🔌 230 V / 50 Hz</p> <p>📊 24h 4,58 kWh</p> <p>📦 kg/net 144</p> <p>📦 kg/br 179</p>		

Tiefkühlische/Gefriertische

	Artikel	Code	Euro
	Tiefkühlisch 109 Liter, 1 Tür, Edelstahl <ul style="list-style-type: none"> · 925 x 700 x 860 mm · Innenmaß: 364 x 580 x 560 mm · Temperatur: -10°C/-20°C · Umluftkühlung, automatische Abtauung · 470 W, 230 V, 50 Hz · Verbrauch: 3,81 kW/h · runde Innenecken für leichte Reinigung · Rostmaß: 328 x 530 mm · Türmaß: 420 x 54 x 630 mm · elektronisches Thermostat, mit LED Display · Verpackungsmaß: 950 x 730 x 910 mm 	GN1100BT.01  	2.099,00
	Tiefkühlisch 180 Liter, 2 Türen GN 1/1, Edelstahl <ul style="list-style-type: none"> · 1380 x 700 x 850 mm, mit Aufkantung · Temperatur: -15°C/-20°C · 375 W, 230 V, 50 Hz · Ventilationsverdampfer zwischen den Türen · Türen mit Automatikverschluss · 1 Rost je Tür, 75 mm Isolierung · Verpackungsmaß: 1420 x 740 x 950 mm 	10111201.01 	2.649,00
	Eismaschine 2 Liter, silber <ul style="list-style-type: none"> · 284 x 424 x 262 mm · Temperatur: -18°C/-35°C · 180 W, 230 V, 50 Hz · vollautomatisch, Fassungsvermögen: 2 Liter · für Speiseeis, Sorbets & Frozen Joghurt · LCD Display, digitaler Timer · Produktionszyklus in 1 Stunde · erfordert kein Eis oder vorheriges Einfrieren · extra breite & tiefe Schüssel für einfaches Löffeln · erweiterte Kühlfunktion (10 Min.) · Verpackungsmaß: 353 x 496 x 324 mm 	EIS15 	389,00
	Eismaschine 2 Liter, silber <ul style="list-style-type: none"> · 272 x 315 x 362 mm · Temperatur: -18°C/-35°C · 180 W, 230 V, 50 Hz · vollautomatisch, Fassungsvermögen: 2 Liter · für Speiseeis, Sorbets & Frozen Joghurt · LCD Display, digitaler Timer · Produktionszyklus in 1 Stunde · erfordert kein Eis oder vorheriges Einfrieren · extra breite & tiefe Schüssel für einfaches Löffeln · erweiterte Kühlfunktion (20 Min.) · Verpackungsmaß: 390 x 330 x 432 mm 	EIS20 	399,00





NEU

NEU

Edelstahl - Schnellkühler & Schockfroster



Temperatur von +70°C auf +3°C in maximal 90 min./+70°C auf -18°C in maximal 240 min.

	Artikel	Code	Euro
 <p>3x GN1/1 oder Blech 600 x 400 mm</p>	<p>Schockfroster mit Aggregat 3x GN 1/1</p> <ul style="list-style-type: none"> · 750 x 740 x 720/750 mm · Innenmaß: 600 x 400 x 280 mm · Kapazität: 14 kg (+3°C)/11 kg (-18°C) · 1150 W, 230 V, 50 Hz · Abstand zw. Einschüben 70 mm · Verpackungsmaß: 800 x 800 x 1000 mm 	<p>AT03 ISO</p> <p>Kältemittel: R452a</p> <p>GN 3x 1/1</p> <p>Rost: GRIDAT07</p>	<p>2.199,00</p>
<p>1150 W 230 V / 50 Hz kg /net 50 kg /br 60</p>			
 <p>5x GN1/1 oder Blech 600 x 400 mm</p>	<p>Schockfroster mit Aggregat 5x GN 1/1</p> <ul style="list-style-type: none"> · 750 x 740 x 850/880 mm · Innenmaß: 610 x 400 x 410 mm · Kapazität: 20 kg (+3°C)/15 kg (-18°C) · 1424 W, 230 V, 50 Hz · Abstand zw. Einschüben 70 mm · Verpackungsmaß: 800 x 800 x 1050 mm 	<p>AT05 ISO</p> <p>Kältemittel: R452a</p> <p>GN 5x 1/1</p> <p>Rost: GRIDAT07</p>	<p>2.489,00</p>
<p>1424 W 230 V / 50 Hz kg /net 60 kg /br 71</p>			
 <p>7x GN1/1 oder Blech 600 x 400 mm</p>	<p>Schockfroster mit Aggregat 7x GN 1/1</p> <ul style="list-style-type: none"> · 750 x 740 x 1260/1290 mm · Innenmaß: 610 x 400 x 770 mm · Kapazität: 25 kg (+3°C)/20 kg (-18°C) · 1490 W, 230 V, 50 Hz · Abstand zw. Einschüben 70 mm · Verpackungsmaß: 800 x 800 x 1400 mm 	<p>AT07 ISO</p> <p>Kältemittel: R452a</p> <p>GN 7x 1/1</p> <p>Rost: GRIDAT07</p>	<p>3.179,00</p>
<p>1490 W 230 V / 50 Hz kg /net 85 kg /br 95</p>			
 <p>10x GN1/1 oder Blech 600 x 400 mm</p>	<p>Schockfroster mit Aggregat 10x GN 1/1</p> <ul style="list-style-type: none"> · 750 x 740 x 1260/1290 mm · Innenmaß: 610 x 400 x 770 mm · Kapazität: 25 kg (+3°C)/20 kg (-18°C) · 2100 W, 230 V, 50 Hz · Abstand zw. Einschüben 70 mm · Verpackungsmaß: 800 x 800 x 1400 mm 	<p>AT10 ISO</p> <p>Kältemittel: R452a</p> <p>GN 10x 1/1</p> <p>Rost: GRIDAT07</p>	<p>3.869,00</p>
<p>2100 W 230 V / 50 Hz kg /net 90 kg /br 101</p>			

Servier-/Transportwagen

	Artikel	Code	Euro				
	Servier-/ Transportwagen 2 Borde <ul style="list-style-type: none"> · 860 x 535 x 940 mm · Chromnickelstahl · 4 Lenkrollen mit 2 Feststellern · Tragfähigkeit: 80 kg 	TROLL2	89,00				
	<table border="1"> <tr> <td>kg/net</td> <td>kg/br</td> </tr> <tr> <td>9,86</td> <td>11,3</td> </tr> </table>	kg/net	kg/br	9,86	11,3		
kg/net	kg/br						
9,86	11,3						
	Servier-/ Transportwagen 3 Borde <ul style="list-style-type: none"> · 860 x 535 x 940 mm · Chromnickelstahl · 4 Lenkrollen mit 2 Feststellern · Tragfähigkeit: 120 kg 	TROLL3	99,00				
	<table border="1"> <tr> <td>kg/net</td> <td>kg/br</td> </tr> <tr> <td>13</td> <td>14</td> </tr> </table>	kg/net	kg/br	13	14		
kg/net	kg/br						
13	14						
	Servier-/ Transportwagen 4 Borde <ul style="list-style-type: none"> · 855 x 535 x 1275 mm · Chromnickelstahl · 4 Lenkrollen mit 2 Feststellern 	TROLLY4	169,00				
	<table border="1"> <tr> <td>kg/net</td> <td>kg/br</td> </tr> <tr> <td>17</td> <td>17,99</td> </tr> </table>	kg/net	kg/br	17	17,99		
kg/net	kg/br						
17	17,99						
	Servier-/ Transportwagen 5 Borde <ul style="list-style-type: none"> · 855 x 535 x 1275 mm · Chromnickelstahl · 4 Lenkrollen mit 2 Feststellern · Verpackungsmaß: 940 x 530 x 200 mm 	TROLLEY5	199,00				
	<table border="1"> <tr> <td>kg/net</td> <td>kg/br</td> </tr> <tr> <td>14,58</td> <td>15,86</td> </tr> </table>	kg/net	kg/br	14,58	15,86		
kg/net	kg/br						
14,58	15,86						











4

Pizza- & Saladetten

Pizzakühltische	67
Pizzatische	69
Pizzakühlaufsätze	70 - 71
Saladetten	72 - 75
Vorbereitungskühltische	68
Sandwichtheken	74

Gastronormbehälter

	Artikel	Code	Euro
	1/1 GN 530 x 325 x 20 mm 530 x 325 x 40 mm 530 x 325 x 65 mm 530 x 325 x 100 mm 530 x 325 x 150 mm 530 x 325 x 200 mm	GN1/1-20 GN1/1-40 GN1/1-65 GN1/1-100 GN1/1-150 GN1/1-200	10,00 13,00 15,00 19,00 26,00 35,00
	1/2 GN 325 x 265 x 20 mm 325 x 265 x 40 mm 325 x 265 x 65 mm 325 x 265 x 100 mm 325 x 265 x 150 mm 325 x 265 x 200 mm	GN1/2-20 GN1/2-40 GN1/2-65 GN1/2-100 GN1/2-150 GN1/2-200	7,00 8,50 10,00 12,00 17,00 22,00
	2/4 GN 530 x 165 x 20 mm 530 x 165 x 40 mm 530 x 165 x 65 mm 530 x 165 x 100 mm 530 x 165 x 150 mm	GN2/4-20 GN2/4-40 GN2/4-65 GN2/4-100 GN2/4-150	12,00 14,00 16,00 21,00 29,00
	1/4 GN 265 x 165 x 20 mm 265 x 165 x 40 mm 265 x 165 x 65 mm 265 x 165 x 100 mm 265 x 165 x 150 mm 265 x 165 x 200 mm	GN1/4-20 GN1/4-40 GN1/4-65 GN1/4-100 GN1/4-150 GN1/4-200	4,00 6,00 8,00 9,00 13,50 24,00
	2/3 GN 354 x 325 x 20 mm 354 x 325 x 40 mm 354 x 325 x 65 mm 354 x 325 x 100 mm 354 x 325 x 150 mm 354 x 325 x 200 mm	GN2/3-20 GN2/3-40 GN2/3-65 GN2/3-100 GN2/3-150 GN2/3-200	8,50 10,00 11,00 14,00 21,00 26,00
	1/3 GN 325 x 176 x 20 mm 325 x 176 x 40 mm 325 x 176 x 65 mm 325 x 176 x 100 mm 325 x 176 x 150 mm 325 x 176 x 200 mm	GN1/3-20 GN1/3-40 GN1/3-65 GN1/3-100 GN1/3-150 GN1/3-200	5,50 6,50 7,50 9,50 15,00 29,00
	1/6 GN 176 x 162 x 65 mm 176 x 162 x 100 mm 176 x 162 x 150 mm 176 x 162 x 200 mm	GN1/6-65 GN1/6-100 GN1/6-150 GN1/6-200	5,00 7,00 13,00 22,00
	1/9 GN 176 x 108 x 65 mm 176 x 108 x 100 mm 176 x 108 x 150 mm	GN1/9-65 GN1/9-100 GN1/9-150	4,40 6,00 14,00









Pizzakühltische

	Artikel	Code	Euro																
	Pizzakühltisch 109 Liter, 1 Tür, 6 Schubladen ungekühlt <ul style="list-style-type: none"> · 955 x 700 x 1020 mm · Innenmaß: 365 x 595 x 456 mm · Temperatur: +2°C/+8°C · statische Kühlung mit Zwangsumwälzung · automatische Abtauung · 100 W, 230 V, 50 Hz, Verbrauch: 1,9 kW/24h · Innenmaß und außen aus Edelstahl · runde Innenmaßecken für leichte Reinigung · elektronisches Thermostat mit LED Display · mit Granit-Arbeitsplatte, Rost: 328 x 530 mm · Schubladen á 485 x 604 x 114 mm · Verpackungsmaß: 1000 x 730 x 1200 mm 	PZ4001.01  	1.929,00																
	<table border="0"> <tr> <td>°C</td> <td>L/net</td> <td>⚡</td> <td>230 V / 50 Hz</td> <td>auto</td> <td>24h</td> <td>kg/net</td> <td>kg/br</td> </tr> <tr> <td>+2/+8</td> <td>88</td> <td>100 W</td> <td></td> <td></td> <td>1,9 kWh</td> <td>183</td> <td>195</td> </tr> </table>	°C	L/net	⚡	230 V / 50 Hz	auto	24h	kg/net	kg/br	+2/+8	88	100 W			1,9 kWh	183	195		
°C	L/net	⚡	230 V / 50 Hz	auto	24h	kg/net	kg/br												
+2/+8	88	100 W			1,9 kWh	183	195												
	Pizzakühltisch 257 Liter, 2 Türen, 6 Schubladen ungekühlt <ul style="list-style-type: none"> · 1420 x 700 x 1020 mm · Innenmaß: 830 x 595 x 456 mm · Temperatur: +2°C/+8°C · statische Kühlung mit Zwangsumwälzung · automatische Abtauung · 155 W, 230 V, 50 Hz, Verbrauch: 2,6 kW/24h · Innenmaß und außen aus Edelstahl · runde Innenmaßecken für leichte Reinigung · elektronisches Thermostat mit LED Display · mit Granit-Arbeitsplatte, Rost: 328 x 530 mm · Schubladen á 485 x 604 x 114 mm · Verpackungsmaß: 1460 x 730 x 1200 mm 	PZ9001.01  	2.089,00																
	<table border="0"> <tr> <td>°C</td> <td>L/net</td> <td>⚡</td> <td>230 V / 50 Hz</td> <td>auto</td> <td>24h</td> <td>kg/net</td> <td>kg/br</td> </tr> <tr> <td>+2/+8</td> <td>201</td> <td>155 W</td> <td></td> <td></td> <td>2,6 kWh</td> <td>248</td> <td>260</td> </tr> </table>	°C	L/net	⚡	230 V / 50 Hz	auto	24h	kg/net	kg/br	+2/+8	201	155 W			2,6 kWh	248	260		
°C	L/net	⚡	230 V / 50 Hz	auto	24h	kg/net	kg/br												
+2/+8	201	155 W			2,6 kWh	248	260												
	Pizzakühltisch 400 Liter, 3 Türen, 6 Schubladen ungekühlt <ul style="list-style-type: none"> · 1885 x 700 x 1020 mm · Innenmaß: 1295 x 595 x 456 mm · Temperatur: +2°C/+8°C · statische Kühlung mit Zwangsumwälzung · automatische Abtauung · 235 W, 230 V, 50 Hz, Verbrauch: 3,15 kW/24h · Innenmaß und außen aus Edelstahl · runde Innenmaßecken für leichte Reinigung · elektronisches Thermostat mit LED Display · mit Granit-Arbeitsplatte, Rost: 328 x 530 mm · Schubladen á 485 x 604 x 114 mm · Verpackungsmaß: 1930 x 730 x 1200 mm 	PZ9031.01  	2.529,00																
	<table border="0"> <tr> <td>°C</td> <td>L/net</td> <td>⚡</td> <td>230 V / 50 Hz</td> <td>auto</td> <td>24h</td> <td>kg/net</td> <td>kg/br</td> </tr> <tr> <td>+2/+8</td> <td>308</td> <td>235 W</td> <td></td> <td></td> <td>3,15 kWh</td> <td>302</td> <td>318</td> </tr> </table>	°C	L/net	⚡	230 V / 50 Hz	auto	24h	kg/net	kg/br	+2/+8	308	235 W			3,15 kWh	302	318		
°C	L/net	⚡	230 V / 50 Hz	auto	24h	kg/net	kg/br												
+2/+8	308	235 W			3,15 kWh	302	318												
	Schubladenblock ungekühlt 6 Schubladen, OHNE Aufkantung <ul style="list-style-type: none"> · 510 x 720 x 800 mm · für Pizzateigbällchen · Edelstahl CNS 18/10 · mit höhenverstellbaren Füßen · Lärm- und wasserisolierte Arbeitsplatten · Verpackungsmaß: 510 x 725 x 950 mm 	CATP2	1.229,00																
	<table border="0"> <tr> <td>kg/net</td> <td>kg/br</td> </tr> <tr> <td>62</td> <td>65</td> </tr> </table>	kg/net	kg/br	62	65														
kg/net	kg/br																		
62	65																		

Vorbereitungskühltische

	Artikel	Code	Euro								
	Vorbereitungskühlisch 396 Liter, 6x GN 1/3, 2 Türen, Edelstahl <ul style="list-style-type: none"> · 1360 x 700 x 1085 mm · Innenmaß: 795 x 580 x 560 mm · Temperatur: +2°C/+8°C · Umluftkühlung, 300 W, 230 V, 50 Hz · automatische Abtauung · inkl. 2 Roste: 328 x 530 mm · Verpackungsmaß: 1390 x 7303 x 1160 mm 	SH2000-700.01 	2.429,00								
	<table border="1"> <tr> <td>GN 1/3</td> <td>°C +2/+8</td> <td>L/net 297</td> <td>⚡ 300 W</td> <td>⚡ 230 V / 50 Hz</td> <td>kg/net 125</td> <td>kg/br 138</td> </tr> </table>	GN 1/3	°C +2/+8	L/net 297	⚡ 300 W	⚡ 230 V / 50 Hz	kg/net 125	kg/br 138			
GN 1/3	°C +2/+8	L/net 297	⚡ 300 W	⚡ 230 V / 50 Hz	kg/net 125	kg/br 138					
	Vorbereitungskühlisch 575 Liter, 8x GN 1/3, 3 Türen, Edelstahl <ul style="list-style-type: none"> · 1795 x 700 x 1085 mm · Innenmaß: 1230 x 580 x 560 mm · Temperatur: +2°C/+8°C · Umluftkühlung, 300 W, 230 V, 50 Hz · automatische Abtauung · inkl. 3 Roste: 328 x 530 mm · Verpackungsmaß: 1160 x 1825 x 730 mm 	SH3000-700.01 	2.799,00								
	<table border="1"> <tr> <td>GN 1/3</td> <td>°C +2/+8</td> <td>L/net 407</td> <td>⚡ 300 W</td> <td>⚡ 230 V / 50 Hz</td> <td>kg/net 146</td> <td>kg/br 166</td> </tr> </table>	GN 1/3	°C +2/+8	L/net 407	⚡ 300 W	⚡ 230 V / 50 Hz	kg/net 146	kg/br 166			
GN 1/3	°C +2/+8	L/net 407	⚡ 300 W	⚡ 230 V / 50 Hz	kg/net 146	kg/br 166					
	Pizzakühlisch mit Granitarbeitsplatte 400 Liter, 6x GN 1/4, 3 Türen, OHNE Kühlaufsatz <ul style="list-style-type: none"> · 1370 x 700 x 1020 mm · Innenmaß: 1295 x 595 x 456 mm · Temperatur: +2°/+8°C · statische Kühlung mit Zwangsumwälzung · automatische Abtauung · 230 W, 230 V, 50 Hz · 3 Türen mit je 7 Schienenpaare (GN 1/1) · Rost: 328 x 530 mm · Verpackungsmaß: 1430 x 730 x 1165 mm 	PK1400.01 	1.379,00								
	<table border="1"> <tr> <td>GN 1/6</td> <td>L/net 308</td> <td>°C +2/+8</td> <td>⚡ 230 W</td> <td>⚡ 230 V / 50 Hz</td> <td>auto ❄️</td> <td>kg/net 195</td> <td>kg/br 210</td> </tr> </table>	GN 1/6	L/net 308	°C +2/+8	⚡ 230 W	⚡ 230 V / 50 Hz	auto ❄️	kg/net 195	kg/br 210		
GN 1/6	L/net 308	°C +2/+8	⚡ 230 W	⚡ 230 V / 50 Hz	auto ❄️	kg/net 195	kg/br 210				
	Schubladenblock ungekühlt 6 Schubladen, OHNE Aufkantung <ul style="list-style-type: none"> · 510 x 720 x 800 mm · für Pizzateigbällchen · Edelstahl CNS 18/10 · mit höhenverstellbaren Füßen · Verpackungsmaß: 510 x 725 x 950 mm 	CATP2	1.229,00								
	<table border="1"> <tr> <td>kg/net 62</td> <td>kg/br 65</td> </tr> </table>	kg/net 62	kg/br 65								
kg/net 62	kg/br 65										
	Pizzateigbehälter <ul style="list-style-type: none"> · aus lebensmittelechtem Kunststoff · 600 x 400 x 70 mm 	E 6407	17,00								
	Deckel weiß <ul style="list-style-type: none"> · 600 x 400 mm 	EN 64	9,50								

Pizzakühltische

	Artikel	Code	Euro
 	<p>Pizzakühltable 428 Liter, 2 Türen</p> <ul style="list-style-type: none"> · 1510 x 800 x 1000 mm · Innenmaß: 945 x 680 x 560 mm · Temperatur: +2°C/+8°C, automatische Abtauung · 300 W, 230 V, 50 Hz, Verbrauch: 2,32 kWh · 2 Türabteile mit je 7 Schienenpaare (600 x 400) · Digitale Temperaturanzeige, Türen abschließbar · Granit-Arbeitsplatte: 30 mm, Aufkantung 150 mm · Verpackungsmaß: 1540 x 840 x 1010 mm <p>Pizzakühlaufsatz, 44,1 Liter · 1500 x 335 x 460 mm, 6x GN 1/3</p>	<p>PK1510.01</p> <p>B</p> <p>VRX1500/ 380.01</p>	<p>2.319,00</p> <p>Kältemittel: R600a</p> <p>699,00</p>
 	<p>Pizzakühltable 221 Liter, 1 Tür, 7 Schubladen ungekühlt</p> <ul style="list-style-type: none"> · 1515 x 800 x 1000 mm · Innenmaß: 435 x 680 x 560 mm · Temperatur: +2°C/+8°C · Umluftkühlung, automatische Abtauung · 300 W, 230 V, 50 Hz, Verbrauch: 2,2 kWh · 1 Türabteil mit je 7 Schienenpaare (600 x 400) · Schubladenmaß: 485 x 630 x 84 mm · Digitale Temperaturanzeige, Türen abschließbar · Granit-Arbeitsplatte: 30 mm, Aufkantung 150 mm · Verpackungsmaß: 1545 x 830 x 1050 mm <p>Pizzakühlaufsatz, 44,1 Liter · 1500 x 335 x 460 mm, 6x GN 1/3</p>	<p>PK1670.01</p> <p>C</p> <p>VRX1500/ 380.01</p>	<p>2.246,00</p> <p>Kältemittel: R600a</p> <p>699,00</p>
 	<p>Pizzakühltable 635 Liter, 3 Türen</p> <ul style="list-style-type: none"> · 2020 x 800 x 1000 mm · Temperatur: +2°C/+8°C, manuelle Abtauung · 300 W, 230 V, 50 Hz, Verbrauch: 2,83 kWh · 3 Türabteile mit je 7 Schienenpaare (600 x 400) · Digitale Temperaturanzeige · Granit-Arbeitsplatte: 30 mm, Aufkantung 150 mm · Verpackungsmaß: 2055 x 830 x 1050 mm <p>Pizzakühlaufsatz, 63,3 Liter · 2000 x 335 x 460 mm 10x GN 1/4</p>	<p>PK2020.01</p> <p>C</p> <p>VRX2000.01</p>	<p>2.599,00</p> <p>Kältemittel: R600a</p> <p>729,00</p>
 	<p>Pizzakühltable 428 Liter, 2 Türen, 7 Schubladen ungekühlt</p> <ul style="list-style-type: none"> · 2025 x 800 x 1000 mm · Innenmaß: 935 x 680 x 560 mm · Temperatur: +2°C/+8°C · Umluftkühlung, automatische Abtauung · 300 W, 230 V, 50 Hz, Verbrauch: 2,41 kWh · 2 Türabteile mit je 7 Schienenpaare (600 x 400) · Schubladenmaß: 485 x 630 x 84 mm · Digitale Temperaturanzeige, Türen abschließbar · Granit-Arbeitsplatte: 30 mm, Aufkantung 150 mm · Verpackungsmaß: 2055 x 830 x 1050 mm <p>Pizzakühlaufsatz, 63,3 Liter · 2000 x 335 x 460 mm, 10x GN 1/4</p>	<p>PK2030.01</p> <p>B</p> <p>VRX2000.01</p>	<p>2.849,00</p> <p>Kältemittel: R600a</p> <p>729,00</p>

Kühlaufsätze mit Edelstahldeckel

Allgemeine Beschreibung

- qualitativ hochwertiger Edelstahl
- stabil und praktisch
- Standard Größendesign für GN 1/3 + GN 1/4 (Tiefe 150 mm)
- PU-Schaum-Isolation
- Außentemperatur geschützt
- reduzierter Energieverbrauch
- Mikro Elektronik Prozessor hält & kontrolliert die Temperatur präzise
- digitale Temperaturanzeige
- Edelstahldeckel
- statische Kühlung und automatische Abtauung
- Temperaturbereich +2°C/+8°C
- Kältemittel: R600a



GN 1/4

Größen	GN	Anschluss	Leistung	Volumen	Code	Euro
1200 x 335 x 300 mm	5x GN 1/4	230 V, 50 Hz	110 W	32,6 Liter	VRXSS1200-1/4.01	619,00
1500 x 335 x 300 mm	7x GN 1/4	230 V, 50 Hz	110 W	44,1 Liter	VRXSS1500-1/4.01	689,00
1600 x 333 x 300 mm	7x GN 1/4	230 V, 50 Hz	110 W	47,9 Liter	VRXSS1600-1/4.01	739,00
1800 x 335 x 300 mm	8x GN 1/4	230 V, 50 Hz	122 W	55,6 Liter	VRXSS1800-1/4.01	769,00
2000 x 335 x 300 mm	10x GN 1/4	230 V, 50 Hz	122 W	63,3 Liter	VRXSS2000-1/4.01	799,00

GN 1/3

Größen	GN	Anschluss	Leistung	Volumen	Code	Euro
1200 x 395 x 300 mm	4x GN 1/3	230 V, 50 Hz	110 W	40,3 Liter	VRXSS1200-1/3.01	679,00
1500 x 395 x 300 mm	6x GN 1/3	230 V, 50 Hz	110 W	54,6 Liter	VRXSS1500-1/3.01	749,00
1600 x 395 x 300 mm	7x GN 1/3	230 V, 50 Hz	110 W	59,3 Liter	VRXSS1600-1/3.01	799,00
1800 x 395 x 300 mm	8x GN 1/3	230 V, 50 Hz	122 W	68,9 Liter	VRXSS1800-1/3.01	869,00
2000 x 395 x 300 mm	9x GN 1/3	230 V, 50 Hz	122 W	78,4 Liter	VRXSS2000-1/3.01	969,00

Kühlaufsätze mit Glasaufsatz

Allgemeine Beschreibung

- qualitativ hochwertiger Edelstahl
- stabil und praktisch
- Standard Größendesign für GN 1/3 + GN 1/4 (Tiefe 150 mm)
- PU-Schaum-Isolation
- Außentemperatur geschützt
- reduzierter Energieverbrauch
- Mikro Elektronik Prozessor hält & kontrolliert die Temperatur präzise
- digitale Temperaturanzeige
- Hygiene-Glas-Schutz
- Befestigungsplatten können in der Höhe verstellt werden
- statische Kühlung und automatische Abtaugung
- Temperaturbereich +2°C/+8°C
- Kältemittel: R600a



GN 1/4

Größen	GN	Anschluss	Leistung	Volumen	Code	Euro
1200 x 335 x 460 mm	5x GN 1/4	230 V, 50 Hz	110 W	32,6 Liter	VRX1200.01	599,00
1400 x 335 x 460 mm	7x GN 1/4	230 V, 50 Hz	110 W	40,2 Liter	VRX1400.01	629,00
1500 x 335 x 460 mm	7x GN 1/4	230 V, 50 Hz	110 W	44,1 Liter	VRX1500.01	649,00
1600 x 333 x 460 mm	7x GN 1/4	230 V, 50 Hz	110 W	47,9 Liter	VRX1600.01	689,00
1800 x 335 x 460 mm	8x GN 1/4	230 V, 50 Hz	122 W	55,6 Liter	VRX1800.01	719,00
2000 x 335 x 460 mm	10x GN 1/4	230 V, 50 Hz	122 W	63,3 Liter	VRX2000.01	729,00

GN 1/3

Größen	GN	Anschluss	Leistung	Volumen	Code	Euro
1200 x 395 x 460 mm	4x GN 1/3	230 V, 50 Hz	110 W	40,3 Liter	VRX1200/380.01	659,00
1400 x 395 x 460 mm	6x GN 1/3	230 V, 50 Hz	110 W	49,8 Liter	VRX1400/380.01	679,00
1500 x 395 x 460 mm	6x GN 1/3	230 V, 50 Hz	110 W	54,6 Liter	VRX1500/380.01	699,00
1600 x 395 x 460 mm	7x GN 1/3	230 V, 50 Hz	110 W	59,3 Liter	VRX1600/380.01	719,00
1800 x 395 x 460 mm	8x GN 1/3	230 V, 50 Hz	122 W	68,9 Liter	VRX1800/380.01	739,00
2000 x 395 x 460 mm	9x GN 1/3	230 V, 50 Hz	122 W	78,4 Liter	VRX2000/380.01	759,00

Saladetten und Pizzakühltische

	Artikel	Code	Euro
	<p>Saladette mit Kühlaufsatz 254 Liter, Edelstahl</p> <ul style="list-style-type: none"> · 900 x 700 x 945 mm · Innenmaß: 830 x 595 x 456 mm · Temperatur: +2°C/+8°C · statische Kühlung mit Zwangsumwälzung, automatische Abtauung · 230 W, 230 V, 50 Hz · Kühlaufsatz: 5x GN 1/6 · inkl. digitale Anzeige · Verpackungsmaß: 970 x 760 x 1175 mm 	<p>PS200.01</p> 	<p>1.239,00</p>
	<p>GN 5x 1/6 °C +2/+8 230 W 230 V / 50 Hz kg/net 67 kg / br 88</p>		
	<p>Saladette 444 Liter, mit Kühlaufsatz</p> <ul style="list-style-type: none"> · 1370 x 700 x 945 mm · Innenmaß: 1295 x 595 x 456 mm · 8x GN1/6 · Temperatur: +2°C/+8°C · 230 W, 230 V, 50 Hz · statische Kühlung mit Zwangsumwälzung · automatische Abtauung · Türmaß: 428 x 36 x 526 mm · Rostmaß: 328 x 530 mm · Arbeitsfläche: 1368 x 360 mm · Verpackungsmaß: 1390 x 730 x 1175 mm 	<p>PS300.01</p> 	<p>1.549,00</p>
	<p>GN 8x 1/6 °C +2/+8 230 W 230 V / 50 Hz kg/net 110 kg / br 124</p>		
	<p>Pizzakühltisch mit Granitplatte</p> <ul style="list-style-type: none"> · Temperatur: +2°C/+8°C · statische Kühlung mit Zwangsumwälzung · automatische Abtauung · 230 V, 50 Hz · Elektronisches Thermostat und digitale LED-Temperaturanzeige <p>254 Liter, GN 1/6, 2 Türen · 900 x 700 x 950 mm</p> <p>285 Liter, 5x 1/6 GN, 2 Türen · 900 x 700 x 1070 mm · Innenmaß: 830 x 515 x 595 mm · 155 W</p>	<p>PSSR200 1.079,00</p> <p>PS900.01 1.029,00</p> 	
	<p>GN 1/6 °C +2/+8 230 W auto 230 V / 50 Hz</p>		
	<p>Pizzakühltisch 400 Liter, GN 8x 1/6, 3 Türen</p> <ul style="list-style-type: none"> · 1365 x 700 x 1070 mm · Innenmaß: 1295 x 515 x 500 mm · Temperatur: +2°C/+8°C · 230 W, 230 V, 50 Hz · Verbrauch: 2,5 kW/24h · PU-Schaum-Isolierung · Elektronisches Thermostat und digitale LED-Temperaturanzeige · automatische Abtauung und Tauwasserverdunstung · Boden mit runden Ecken zur leichten Reinigung · Verpackungsmaß: 1390 x 730 x 1264 mm 	<p>PS903.01 1.679,00</p> 	
	<p>GN 1/6 °C +2/+8 230 W auto 230 V / 50 Hz kg/net 150 kg / br 165</p>		

Saladetten

	Artikel	Code	Euro
	<p>Saladette 148,2 Liter, 2 Türen, Edelstahl, mit Glasaufsatz</p> <ul style="list-style-type: none"> · 880 x 700 x 1075 mm · 199 W, 230 V/50 Hz · Temperatur: +2°/+8°C · automatische Abtauung · für Benutzung von GN 1/1-Rost und Behälter · 1 Rost pro Tür, Innen aus Edelstahl, FCKW-frei · Türen mit Automatikverschluss · elektronische Kontrollanzeige · Verpackungsmaß: 920 x 740 x 1100 mm 	<p>10109209.01</p> <p></p>	1.599,00
	<p>Saladette mit Glasaufsatz 700 Liter, 2 Türen, Edelstahl</p> <ul style="list-style-type: none"> · 900 x 700 x 870 mm · 2x GN 1/1 + 3x GN 1/6 · Höhe mit Glasaufbau 1300 mm · Temperatur: +2°/+8°C · statische Kühlung mit Zwangsumwälzung · automatische Abtauung · 155 W, 230 V, 50 Hz · Kunststoffschneidebrett vorne · PU-Schaum-Isolierung · digitale Temperaturanzeige · Verpackungsmaß: 978 x 760 x 1054 mm 	<p>S910-GLAS.01</p>	1.629,00
	<p>Saladette mit Glasaufsatz 400 Liter, 3 Türen</p> <ul style="list-style-type: none"> · 1375 x 700 x 870/1375 mm · Innenmaß: 1295 x 595 x 456 mm · 235 W, 230 V, 50 Hz · Temperatur: +2°/+8°C · Kühlfläche für 4x GN 1/1 · Kunststoffschneidebrett vorne · digitale Temperaturanzeige · Rost: 323 x 570 mm · Verpackungsmaß: 1390 x 730 x 1054 mm 	<p>S903CG.01</p> <p></p>	1.559,00
	<p>Saladette, Kantglasausführung 220 Liter, 3 Türen</p> <ul style="list-style-type: none"> · 1380 x 700 x 1058 mm · Temperatur: +4°C/+10°C · 300 W, 230 V, 50 Hz · Edelstahl · Verpackungsmaß: 1450 x 730 x 1300 mm 	<p>PKGA903</p> <p></p>	1.899,00

GN 1/1 °C +2/+8 199 W 230 V / 50 Hz auto kg/net 82 kg/br 105

°C +2/+8 155 W 230 V / 50 Hz auto kg/net 85 kg/br 98

GN 4x 1/1 °C +2/+8 235 W 230 V / 50 Hz kg/net 120 kg/br 149

°C +4/+10 300 W 230 V / 50 Hz kg/net 91 kg/br 111

Saladetten und Sandwich Theken



	Artikel	Code	Euro
	<p>Sandwich Theke 465 Liter, Edelstahl</p> <ul style="list-style-type: none"> · 1795 x 700 x 860 mm · Innenmaß: 1230 x 580 x 560 mm · Umluftkühlung, automatisch Abtauung · Temperatur: -2°C/+8°C · 350 W, 230 V, 50 Hz · Verbrauch: 2,4 kW/24h · Abmessungen Glasaufsatz: 1425 x 760 x 310 mm · inkl. 3 Roste: 328 x 530 mm · Verpackungsmaß: 1825 x 730 x 910 mm 	Sal179.01	2.399,00
			
	<p>Sandwich Theke 345 Liter, Edelstahl</p> <ul style="list-style-type: none"> · 1400 x 700 x 850-1350 mm · Innenmaß: 1230 x 580 x 560 mm · GN 4x GN 1/1 · Umluftkühlung, automatisch Abtauung · Temperatur: 0°C/+10°C · 507 W, 230 V, 50 Hz · beleuchtete Glasvitrine · Umgebungs-Temperatur: +43°C · Verpackungsmaß: 1450 x 750 x 900 mm 	Sal140.01	2.499,00
			







Saladetten









	Artikel	Code	Euro
	<p>Saladette 2 Türen, 257 Liter, 2x GN 1/1 + 1x GN 1/2</p> <ul style="list-style-type: none"> · 900 x 700 x 870 mm · Innenmaß: 830 x 595 x 456 mm · Temperatur: +2°C/+8°C, automatische Abtauung · statische Kühlung mit Zwangsumwälzung · 155 W, 230 V, 50 Hz · PU-Schaum-Isolierung · digitale Temperaturanzeige · Isolierung 35 mm, Rostmaß: 323 x 570 mm · Verpackungsmaß: 978 x 760 x 1060 mm 	<p>S900.01</p> 	<p>779,00</p>
	<p>Saladette 2 Türen, 302 Liter, 3x GN 1/1, Edelstahl</p> <ul style="list-style-type: none"> · 1045 x 700 x 870 mm · Innenmaß: 975 x 595 x 456 mm · Temperatur: +2°C/+8°C, automatische Abtauung · statische Kühlung mit Zwangsumwälzung · 175 W, 230 V, 50 Hz · einstellbare Füße, PU-Schaum-Isolierung · digitale Temperaturanzeige, Isolierung 35 mm · Rostmaß: 323 x 570 mm · Führungsschiene: 565 mm, U-Form · Kunststoffschneidbrett vorne · Verpackungsmaß: 1115 x 760 x 978 mm 	<p>S902.01</p> 	<p>1.229,00</p>
	<p>Saladette 3 Türen, 400 Liter, 4x GN 1/1, Edelstahl</p> <ul style="list-style-type: none"> · 1365 x 700 x 870 mm · Innenmaß: 1295 x 595 x 456 mm · Temperatur: +2°C/+8°C, automatische Abtauung · statische Kühlung mit Zwangsumwälzung · 235 W, 230 V, 50 Hz · einstellbare Füße, PU-Schaum-Isolierung · digitale Temperaturanzeige, Isolierung 35 mm · Rostmaß: 323 x 570 mm · Führungsschiene: 570 mm, U-Form · Kunststoffschneidbrett vorne · Verpackungsmaß: 1390 x 730 x 1054 mm 	<p>S903.01</p> 	<p>1.289,00</p>
	<p>Saladette 350 Liter, 3 Türen</p> <ul style="list-style-type: none"> · 1380 x 700 x 880 mm · Temperatur: +4°C/+10°C · 300 W, 230 V, 50 Hz · Edelstahl-Schiebedeckel · aus Edelstahl · Türen austauschbar · Verpackungsmaß: 1450 x 730 x 1000 mm 	<p>SA903</p> 	<p>1.559,00</p>

Gastronormbehälter

	Artikel	Code	Euro
	Deckel flach, mit Löffelaussparung	GD 1/1 L	15,00
	Deckel flach ohne Löffelaussparung (Preise minus 2,00 € pro Stück / Code-Nr. ohne L)	GD 2/3 L	11,00
		GD 1/2 L	11,00
		GD 1/3 L	8,00
		GD 1/4 L	7,00
		GD 1/6 L	7,00
		GD 1/9 L	5,00
	Steg - 325 mm	550 - 650	6,00
	Steg - 530 mm	550 - 651	7,00
 inkl. Behälter und Deckel	GN Behälter Aufsatzbord inkl. Behälter und Deckel · für 6 x GN 1/6-150 · 980 x 250 x 210 mm · Verpackungmaß: 1000 x 270 x 230 mm	460180	139,00

GN-Behälter gelocht	Artikel	Code	Euro			
	1/1 GN 530 x 325 x 20 mm 530 x 325 x 40 mm 530 x 325 x 60 mm 530 x 325 x 100 mm 530 x 325 x 150 mm	GN1/1-20GL GN1/1-40GL GN1/1-60GL GN1/1-100GL GN1/1-150GL	27,00 30,00 35,00 44,00 59,00			
		2/3 GN 354 x 325 x 40 mm 354 x 325 x 65 mm 354 x 325 x 100 mm 354 x 325 x 150 mm 354 x 325 x 200 mm	GN2/3-40GL GN2/3-65GL GN2/3-100GL GN2/3-150GL GN2/3-200GL	24,00 26,00 36,00 53,00 60,00		
			1/2 GN 325 x 265 x 60 mm 325 x 265 x 100 mm 325 x 265 x 150 mm 325 x 265 x 200 mm	GN1/2-60GL GN1/2-100GL GN1/2-150GL GN1/2-200GL	26,00 32,00 44,00 51,00	
				1/3 GN 325 x 176 x 40 mm 325 x 176 x 65 mm 325 x 176 x 100 mm 325 x 176 x 150 mm 325 x 176 x 200 mm	GN1/3-40GL GN1/3-65GL GN1/3-100GL GN1/3-150GL GN1/3-200GL	17,00 19,00 29,00 43,00 60,00

Gastronormbehälter

	Artikel	Code	Euro
	1/1 GN 530 x 325 x 20 mm 530 x 325 x 40 mm 530 x 325 x 65 mm 530 x 325 x 100 mm 530 x 325 x 150 mm 530 x 325 x 200 mm	GN1/1-20 GN1/1-40 GN1/1-65 GN1/1-100 GN1/1-150 GN1/1-200	10,00 13,00 15,00 19,00 26,00 35,00
	1/2 GN 325 x 265 x 20 mm 325 x 265 x 40 mm 325 x 265 x 65 mm 325 x 265 x 100 mm 325 x 265 x 150 mm 325 x 265 x 200 mm	GN1/2-20 GN1/2-40 GN1/2-65 GN1/2-100 GN1/2-150 GN1/2-200	7,00 8,50 10,00 12,00 17,00 22,00
	2/4 GN 530 x 165 x 20 mm 530 x 165 x 40 mm 530 x 165 x 65 mm 530 x 165 x 100 mm 530 x 165 x 150 mm	GN2/4-20 GN2/4-40 GN2/4-65 GN2/4-100 GN2/4-150	12,00 14,00 16,00 21,00 29,00
	1/4 GN 265 x 165 x 20 mm 265 x 165 x 40 mm 265 x 165 x 65 mm 265 x 165 x 100 mm 265 x 165 x 150 mm 265 x 165 x 200 mm	GN1/4-20 GN1/4-40 GN1/4-65 GN1/4-100 GN1/4-150 GN1/4-200	4,00 6,00 8,00 9,00 13,50 24,00
	2/3 GN 354 x 325 x 20 mm 354 x 325 x 40 mm 354 x 325 x 65 mm 354 x 325 x 100 mm 354 x 325 x 150 mm 354 x 325 x 200 mm	GN2/3-20 GN2/3-40 GN2/3-65 GN2/3-100 GN2/3-150 GN2/3-200	8,50 10,00 11,00 14,00 21,00 26,00
	1/3 GN 325 x 176 x 20 mm 325 x 176 x 40 mm 325 x 176 x 65 mm 325 x 176 x 100 mm 325 x 176 x 150 mm 325 x 176 x 200 mm	GN1/3-20 GN1/3-40 GN1/3-65 GN1/3-100 GN1/3-150 GN1/3-200	5,50 6,50 7,50 9,50 15,00 29,00
	1/6 GN 176 x 162 x 65 mm 176 x 162 x 100 mm 176 x 162 x 150 mm 176 x 162 x 200 mm	GN1/6-65 GN1/6-100 GN1/6-150 GN1/6-200	5,00 7,00 13,00 22,00
	1/9 GN 176 x 108 x 65 mm 176 x 108 x 100 mm 176 x 108 x 150 mm	GN1/9-65 GN1/9-100 GN1/9-150	4,40 6,00 14,00

Thermometer

	Artikel	Code	Euro
	<p>Fleisch-Thermometer (digital)</p> <ul style="list-style-type: none"> · 150 x 22 x 15 mm · Messbereich: -50°C/+125°C, (-58°F/+302°F) · Batterie: 1x 1,5 V (LR44) · Einstehtiefe Edelstahlfühler: Ø 3,8 x 70 mm · Verpackungsmaß: 200 x 65 x 20 mm 	YSW-018	16,00
	<p>°C -50/+125</p>		
	<p>Grill-Thermometer mit Fernbedienung</p> <ul style="list-style-type: none"> · Sender: 90 x 65 x 90 mm · Empfänger: 105 x 65 x 25 mm · Edelstahlfühler: Ø 3,8 x 300 mm · Messbereich: -10°C/+250°C · Kabellänge: 870 mm · 4 wählbare Garpunkte für 5 Fleischsorten: Rind, Kalb, Schwein, Huhn, Truthahn · frei wählbare Temperatur und Timer · Signalton bei Erreichen von Garpunkt · Temperatur oder Zeitvorgabe · Verpackungsmaß: 245 x 75 x 75 mm 	YSW-020A	49,00
	<p>°C -10/+250</p>		
 <p>spülmaschinenfest</p>	<p>Fritteusen-Thermometer</p> <ul style="list-style-type: none"> · Ø 52 x 310 mm · Messbereich: +38°C/+205°C, (+100°F/+400°F) · Edelstahlfühler: Ø 3,8 x 296 mm · inkl. Befestigungsklemme 	YSW-002A	9,00
	<p>°C +38/+205</p>		









5

Ausschank

Flaschen-Kühltruhen	80
Bierkühler	81
Ausschanktheken	81 - 85
Flaschenkühler	86
Flaschenkühltische	87 - 91
Fasskühler	92 - 93

Flaschen-Kühltruhen +1°C/+10°C

Zum Aufbewahren von Bierflaschen

















	Artikel	Code	Euro
	<p>NEU</p> <p>Flaschen-Kühltruhe 133 Liter</p> <ul style="list-style-type: none"> · 573 x 573 x 904 mm · Innenmaß: 463 x 463 x 552 mm · Temperatur: +1°C/+10°C · Aluminiumrahmen · 4 Räder mit 2 Bremsen · mechanisches Thermostat  <p> °C L/net kg/net kg/br +1/+10 107 40 47 </p>	<p>KFT160</p> 	<p>479,00</p>
	<p>NEU</p> <p>Flaschen-Kühltruhe 208 Liter</p> <ul style="list-style-type: none"> · 763 x 653 x 904 mm · Innenmaß: 639 x 529 x 552 mm · Temperatur: +1°C/+10°C · Aluminiumrahmen · 4 Räder mit 2 Bremsen · mechanisches Thermostat  <p> °C L/net kg/net kg/br +1/+10 170 45 53 </p>	<p>KFT210</p> 	<p>579,00</p>
	<p>NEU</p> <p>Flaschen-Kühltruhe 314 Liter</p> <ul style="list-style-type: none"> · 1043 x 659 x 904 mm · Innenmaß: 915 x 529 x 552 mm · Temperatur: +1°C/+10°C · Aluminiumrahmen · 4 Räder mit 2 Bremsen · mechanisches Thermostat  <p> °C L/net kg/net kg/br +1/+10 258 55 62 </p>	<p>KFT310</p> 	<p>629,00</p>

Ausschanktheken

















	Artikel	Code	Euro
	Bierkühler 128 Liter <ul style="list-style-type: none"> · 815 x 515 x 665 mm · 95 W, 230 V, 50 Hz · statische Kühlung · max. 60 Liter Fass · Edelstahltür · Verpackungsmaß: 855 x 565 x 710 mm · mit CO²-Flasche, Zapfhahn, Bierschlauch 	BK-128  	679,00
	NEU Ausschanktheke 241 Liter, schwarz - 1 Zapfhahn <ul style="list-style-type: none"> · 592 x 810 x 982 mm · Innenmaß: 508 x 660 x 759 mm · 1 Tür: 568 x 36 x 817 mm · Temperatur: +1°C/+8°C · Umluftkühlung, automatische Abtauung · 175 W, 230 V, 50 Hz · Schankbalken: Ø 77 mm, · Höhe des Zapfhahns: 332 mm · Innen: Edelstahl, Boden S/S 304 · Außen: pulverbeschichteter Stahl, schwarz 	BK-29 	1.799,00
	NEU Ausschanktheke 346 Liter, schwarz - 1 Zapfhahn <ul style="list-style-type: none"> · 1247 x 620 x 1060 mm · Innenmaß: 915 x 460 x 746 mm · 2 Türen: je 480 x 36 x 812 mm · Temperatur: +1°C/+8°C · Umluftkühlung, automatische Abtauung · 210 W, 230 V, 50 Hz · Schankbalken: Ø 77 mm · Höhe des Zapfhahns: 332 mm · Innen: Edelstahl, Boden S/S 304 · Außen: pulverbeschichteter Stahl, schwarz · Verpackungsmaß: 1287 x 680 x 1130 mm 	BK-48-1.01 	2.119,00
	NEU Ausschanktheke 462 Liter, schwarz - 1 Zapfhahn <ul style="list-style-type: none"> · 1552 x 620 x 1060 mm · Innenmaß: 1219 x 460 x 746 mm · 2 Türen: je 632 x 36 x 812 mm · Temperatur: +1°C/+8°C · Umluftkühlung, automatische Abtauung · 230 W, 230 V, 50 Hz · Schankbalken: Ø 77 mm · Höhe des Zapfhahns: 332 mm · Innen: Edelstahl, Boden S/S 304 · Außen: pulverbeschichteter Stahl, schwarz · Verpackungsmaß: 1591 x 680 x 1130 mm 	BK-60-1 	2.364,00
	2 Zapfhähne <ul style="list-style-type: none"> · 1247 x 620 x 1060 mm · Innenmaß: 915 x 460 x 746 mm · 2 Türen: je 480 x 36 x 812 mm · Temperatur: +1°C/+8°C · Umluftkühlung, automatische Abtauung · 210 W, 230 V, 50 Hz · Schankbalken: Ø 77 mm · Höhe des Zapfhahns: 332 mm · Innen: Edelstahl, Boden S/S 304 · Außen: pulverbeschichteter Stahl, schwarz · Verpackungsmaß: 1287 x 680 x 1130 mm 	BK-48-2.01 	2.399,00



Ausschanktheken - Umluft

	Artikel	Code	Euro
 <p>→ Wird ohne Mischbatterie & Zapfanlage geliefert!</p>	Ausschanktheke 2 Türen <ul style="list-style-type: none"> · 1550 x 700 x 930 mm · Umluftkühlung · 350 W · Türen für Flaschen oder Fässer · 1 Spülbecken links · Verpackungsmaß: 1660 x 760 x 1020 mm 	F-BL	3.679,00
	wie oben, nur mit Spülbecken rechts	F-BR	3.679,00
<div style="display: flex; justify-content: space-around; align-items: center;">  350 W  115  127 </div>			
 <p>→ Wird ohne Mischbatterie & Zapfanlage geliefert!</p>	Ausschanktheke 1 Tür, 2 Schubladen <ul style="list-style-type: none"> · 1550 x 700 x 930 mm · Umluftkühlung · 350 W · Türen für Flaschen oder Fässer · Schubladen für Flaschen · 1 Spülbecken links · Verpackungsmaß: 1660 x 760 x 1020 mm 	F1-BL	3.829,00
	wie oben, nur mit Spülbecken rechts	F1-BR	3.829,00
<div style="display: flex; justify-content: space-around; align-items: center;">  350 W  134  146 </div>			
 <p>→ Wird ohne Mischbatterie & Zapfanlage geliefert!</p>	Ausschanktheke 4 Schubladen <ul style="list-style-type: none"> · 1550 x 700 x 930 mm · Umluftkühlung · 350 W · Schubladen für Flaschen · 1 Spülbecken links · Verpackungsmaß: 1660 x 760 x 1020 mm 	F2-BL	4.129,00
	wie oben, nur mit Spülbecken rechts	F2-BR	4.129,00
<div style="display: flex; justify-content: space-around; align-items: center;">  350 W  148  160 </div>			
 <p>→ Wird ohne Mischbatterie & Zapfanlage geliefert!</p>	Ausschanktheke 2 Türen <ul style="list-style-type: none"> · 1950 x 700 x 930 mm · Umluftkühlung · 350 W · Türen für Flaschen oder Fässer · 2 Spülbecken links · Verpackungsmaß: 2060 x 760 x 1020 mm 	S-BL	3.989,00
	wie oben, nur mit Spülbecken rechts	S-BR	3.989,00
<div style="display: flex; justify-content: space-around; align-items: center;">  350 W  155  168 </div>			

Ausschanktheken - Umluft

	Artikel	Code	Euro
 <p>→ Wird ohne Mischbatterie & Zapfanlage geliefert!</p>	Ausschanktheke 1 Tür, 2 Schubladen · 1950 x 700 x 930 mm · Umluftkühlung · 350 W · Türen für Flaschen oder Fässer · Schubladen für Flaschen · 2 Spülbecken links · Verpackungsmaß: 2060 x 760 x 1020 mm	S1-BL	4.399,00
	wie oben, nur mit Spülbecken rechts	S1-BR	4.399,00
<div style="display: flex; justify-content: space-around;">  350 W  156  173 </div>			
 <p>→ Wird ohne Mischbatterie & Zapfanlage geliefert!</p>	Ausschanktheke 4 Schubladen · 1950 x 700 x 930 mm · Umluftkühlung · 350 W · Schubladen für Flaschen · 2 Spülbecken links · Verpackungsmaß: 2060 x 760 x 1020 mm	S2-BL	4.749,00
	wie oben, nur mit Spülbecken rechts	S2-BR	4.749,00
<div style="display: flex; justify-content: space-around;">  350 W  165  180 </div>			
 <p>→ Wird ohne Mischbatterie & Zapfanlage geliefert!</p>	Ausschanktheke 2 Türen, 2 Schubladen · 2500 x 700 x 930 mm · Umluftkühlung · 400 W · Türen für Flaschen oder Fässer · Schubladen für Flaschen · 2 Spülbecken links · Verpackungsmaß: 2560 x 760 x 1020 mm	B1-BL	5.149,00
	wie oben, nur mit Spülbecken rechts	B1-BR	5.149,00
<div style="display: flex; justify-content: space-around;">  350 W  189  207 </div>			
 <p>→ Wird ohne Mischbatterie & Zapfanlage geliefert!</p>	Ausschanktheke 1 Tür, 4 Schubladen · 2500 x 700 x 930 mm · Umluftkühlung · 400 W · Türen für Flaschen oder Fässer · Schubladen für Flaschen · 2 Spülbecken links · Verpackungsmaß: 2560 x 760 x 1020 mm	B2-BL	5.439,00
	wie oben, nur mit Spülbecken rechts	B2-BR	5.439,00
<div style="display: flex; justify-content: space-around;">  350 W  199  217 </div>			

Ausschanktheken mit Türschloss

	Artikel	Code	Euro
	Ausschanktheke 2 Türen <ul style="list-style-type: none"> · 1550 x 700 x 960 mm · Temperatur: -2°C/+8°C · Umluftkühlung · 360 W, 230 V, 50 Hz · Türen für Flaschen oder Fässer · 1 Spülbecken links · Verpackungsmaß: 1650 x 800 x 1130 mm 	 	F-BLCH 2.929,00
			wie oben, nur mit Spülbecken rechts
  			
	Ausschanktheke 1 Tür, 2 Schubladen <ul style="list-style-type: none"> · 1550 x 700 x 960 mm · Temperatur: -2°C/+8°C · Umluftkühlung · 360 W, 230 V, 50 Hz · Türen für Flaschen oder Fässer · Schubladen für Flaschen · 1 Spülbecken links · Verpackungsmaß: 1650 x 800 x 1130 mm 	 	F1-BLCH 3.199,00
			wie oben, nur mit Spülbecken rechts
  			
	Ausschanktheke 4 Schubladen <ul style="list-style-type: none"> · 1550 x 700 x 960 mm · Temperatur: -2°C/+8°C · Umluftkühlung · 360 W, 230 V, 50 Hz · Schubladen für Flaschen · 1 Spülbecken links · Verpackungsmaß: 1650 x 800 x 1130 mm 	 	F2-BLCH 3.999,00
			wie oben, nur mit Spülbecken rechts
  			
	Ausschanktheke 2 Türen <ul style="list-style-type: none"> · 1950 x 700 x 960 mm · Temperatur: -2°C/+8°C · Umluftkühlung · 360 W, 230 V, 50 Hz · Türen für Flaschen oder Fässer · 2 Spülbecken links · Verpackungsmaß: 2050 x 800 x 1130 mm 	 	S-BLCH 3.319,00
			wie oben, nur mit Spülbecken rechts
  			



Ausschanktheken mit Türschloss

	Artikel	Code	Euro
	Ausschanktheke 1 Tür, 2 Schubladen <ul style="list-style-type: none"> · 1950 x 700 x 960 mm · Temperatur: -2°C/+8°C · Umluftkühlung · 360 W, 230 V, 50 Hz · Türen für Flaschen oder Fässer · Schubladen für Flaschen · 2 Spülbecken links · Verpackungsmaß: 2050 x 800 x 1100 mm 	NEU 	S1-BLCH 3.599,00
			wie oben, nur mit Spülbecken rechts
<div style="display: flex; justify-content: space-around; align-items: center;">  360 W  205  225 </div>			
	Ausschanktheke 4 Schubladen <ul style="list-style-type: none"> · 1950 x 700 x 960 mm · Temperatur: -2°C/+8°C · Umluftkühlung · 360 W, 230 V, 50 Hz · Schubladen für Flaschen · 2 Spülbecken links · Verpackungsmaß: 2050 x 800 x 1100 mm 	NEU 	S2-BLCH 4.299,00
			wie oben, nur mit Spülbecken rechts
<div style="display: flex; justify-content: space-around; align-items: center;">  360 W  205  225 </div>			
	Ausschanktheke 2 Türen, 2 Schubladen <ul style="list-style-type: none"> · 2500 x 700 x 960 mm · Temperatur: -2°C/+8°C · Umluftkühlung · 460 W, 230 V, 50 Hz · Türen für Flaschen oder Fässer · Schubladen für Flaschen · 2 Spülbecken links · Verpackungsmaß: 2500 x 800 x 1100 mm 	NEU 	B1-BLCH 4.389,00
			wie oben, nur mit Spülbecken rechts
<div style="display: flex; justify-content: space-around; align-items: center;">  460 W  255  287 </div>			
	Ausschanktheke 1 Tür, 4 Schubladen <ul style="list-style-type: none"> · 2500 x 700 x 960 mm · Temperatur: -2°C/+8°C · Umluftkühlung · 460 W, 230 V, 50 Hz · Türen für Flaschen oder Fässer · Schubladen für Flaschen · 2 Spülbecken links · Verpackungsmaß: 2600 x 800 x 1100 mm 	NEU 	B2-BLCH 4.899,00
			wie oben, nur mit Spülbecken rechts
<div style="display: flex; justify-content: space-around; align-items: center;">  460 W  255  287 </div>			

Flaschenkühler

	Artikel	Code	Euro
 <div style="position: absolute; top: 10px; right: 10px; background-color: red; color: white; padding: 5px; font-weight: bold;">NEU</div>	Flaschenkühler 279 Liter, schwarz, mit Schiebedeckel <ul style="list-style-type: none"> · 935 x 687 x 888 mm · Innenmaß: 824 x 583 x 725 mm · Temperatur: +2°C/+8°C · Kältemittel: R600a · Umluftkühlung · automatische Abtauung · 300 W, 230 V, 50 Hz · Verpackungsmaß: 970 x 730 x 1010 mm 	FKB-900	849,00
 <div style="position: absolute; top: 10px; right: 10px; background-color: red; color: white; padding: 5px; font-weight: bold;">NEU</div>	Flaschenkühler 417 Liter, schwarz, mit Schiebedeckel <ul style="list-style-type: none"> · 935 x 687 x 888 mm · Innenmaß: 1151 x 583 x 725 mm · Temperatur: +2°C/+8°C · Kältemittel: R600a · Umluftkühlung · automatische Abtauung · 350 W, 230 V, 50 Hz · Verpackungsmaß: 1300 x 740 x 1010 mm 	FKB-1250	999,00
 <div style="position: absolute; top: 10px; right: 10px; background-color: red; color: white; padding: 5px; font-weight: bold;">NEU</div>	Flaschenkühler 577 Liter, schwarz, mit Schiebedeckel <ul style="list-style-type: none"> · 1634 x 687 x 888 mm · Innenmaß: 1530 x 583 x 725 mm · Temperatur: +2°C/+8°C · Kältemittel: R600a · Umluftkühlung · automatische Abtauung · 350 W, 230 V, 50 Hz · Verpackungsmaß: 1680 x 740 x 1010 mm 	FKB-1650	1.149,00
 <div style="position: absolute; top: 10px; right: 10px; background-color: red; color: white; padding: 5px; font-weight: bold;">NEU</div> <p>Edelstahl inkl. Rollen</p>	Party-Kühler 50 Liter, für 21 Flaschen <ul style="list-style-type: none"> · Ø 503 x 838 mm, Edelstahl · Maße mit ausgeklappten Ablagen: 918 x 503 x 838 mm · Temperatur: +4°C/+15°C · Kältemittel: R600a · 60 W, 230 V, 50 Hz · Lautstärke: 46 dB · 2 verstell- und klappbare Ablagen in schwarz inkl. Hängkörbe für Flaschen · temperierte Glasoberfläche · Steuerelement mit digitalem Display · inklusive Rollen · Verpackungsmaß: 550 x 550 x 880 mm 	PAT-50SS	429,00







Flaschenkühltisch

	Artikel	Code	Euro
 <p>NEU</p> <p>Neuheit: Praktischer Kühlbereich für 8 Flaschen</p>	<p>Flaschenkühltisch 380 Liter, mit Klapptüren</p> <ul style="list-style-type: none"> · 1668 x 570 x 860 mm · Innenmaß: 1588 x 480 x 716 mm · 2 Türen: je 515 x 37,5 x 769 mm · Temperatur: 0°C/+10°C · Kältemittel: R290 · Umluftkühlung · automatische Abtauung · 320 W, 230 V, 50 Hz · Verbrauch: 4,43 kW/24h · elektrischer Regler mit Temperaturanzeige · extra Kühlbereich für 8 Flaschen oberhalb des Aggregats: 410 x 326 x 568 mm · verschließbar · inkl. 4 Einlegeböden: 460 x 430 mm · Verpackungsmaß: 1728 x 630 x 1030 mm <p> °C 0/+10 ⚡ 320 W 🔌 230 V / 50 Hz 📊 4,43 kWh 🔄 auto 🧊 📦 kg/net 95 📦 kg/br 133 </p>	BCD2100	2.319,00
 <p>NEU</p> <p>Neuheit: Praktischer Kühlbereich für 8 Flaschen</p>	<p>Flaschenkühltisch 510 Liter, mit Klapptüren</p> <ul style="list-style-type: none"> · 2203 x 570 x 860 mm · Innenmaß: 2128 x 480 x 716 mm · 3 Türen: je 515 x 37,5 x 769 mm · Temperatur: 0°C/+10°C · Kältemittel: R290 · Umluftkühlung · automatische Abtauung · 320 W, 230 V, 50 Hz · Verbrauch: 4,43 kW/24h · elektrischer Regler mit Temperaturanzeige · extra Kühlbereich für 8 Flaschen oberhalb des Aggregats: 410 x 326 x 568 mm · verschließbar · inkl. 6 Einlegeböden: 460 x 430 mm · Verpackungsmaß: 2268 x 630 x 1030 mm <p> °C 0/+10 ⚡ 320 W 🔌 230 V / 50 Hz 📊 4,43 kWh 🔄 auto 🧊 📦 kg/net 110 📦 kg/br 145 </p>	BCD3100	2.629,00



Flaschenkühltische mit Glastüren



	Artikel	Code	Euro
	<p>Flaschenkühltisch 2 Glastüren, schwarz</p> <ul style="list-style-type: none"> · 1462 x 513 x 860 mm · Innenmaß: 1082 x 415 x 720 mm · Temperatur: 0°C/+10°C · Umluftkühlung · 280 W, 230 V, 50 Hz · automatische Abtauung · Innenbeleuchtung · abschließbar · inkl. 4 höhenverstellbare Böden: 430 x 395 mm · Verpackungsmaß: 1522 x 575 x 1015 mm 	<p>CCB210G.01</p> 	<p>1.619,00</p>
	<p>Flaschenkühltisch 3 Glastüren, schwarz</p> <ul style="list-style-type: none"> · 2002 x 513 x 860 mm · Innenmaß: 1622 x 415 x 720 mm · Temperatur: 0°C/+10°C · Umluftkühlung · 280 W, 230 V, 50 Hz · automatische Abtauung · Innenbeleuchtung, abschließbar · inkl. 8 höhenverstellbare Böden: 6x 430 x 395 mm 2x 95 x 335 mm · Verpackungsmaß: 2062 x 575 x 1015 mm 	<p>CCB310G.01</p> 	<p>1.959,00</p>
	<p>Flaschenkühltisch 4 Glastüren, schwarz</p> <ul style="list-style-type: none"> · 2542 x 513 x 860 mm · Innenmaß: 2162 x 415 x 720 mm · Temperatur: 0°C/+10°C · Umluftkühlung · 440 W, 230 V, 50 Hz · automatische Abtauung · Innenbeleuchtung, abschließbar · inkl. 12 höhenverstellbare Böden: 8x 430 x 395 mm, 4x 95 x 335 mm · Verpackungsmaß: 2602 x 575 x 1015 mm 	<p>CCB410G.01</p> 	<p>2.499,00</p>

°C 0/+10 L/net 350 280 W 230 V / 50 Hz auto kg/net 100 kg/br 121

°C 0/+10 L/net 537 280 W 230 V / 50 Hz auto kg/net 125 kg/br 154

°C 0/+10 L/net 698 440 W 230 V / 50 Hz auto kg/net 150 kg/br 171

Flaschenkühltische

	Artikel	Code	Euro																											
	<p>Flaschenkühltisch 350 Liter, 2 Türen, schwarz</p> <ul style="list-style-type: none"> · 1462 x 513 x 860 mm · Innenmaß: 1082 x 415 x 760 mm · Temperatur: 0°C/+10°C · Umluftkühlung · 320 W, 230 V, 50 Hz · Verbrauch: 2,35 kWh/24h · automatische Abtauung · Rostmaß: 430 x 395 mm · abschließbar · inkl. 4 höhenverstellbare Roste: 430 x 395 mm · Verpackungsmaß: 1522 x 575 x 1000 mm 	<p>BBC210.01</p>  	<p>1.579,00</p>																											
	<table border="1"> <tr> <td>°C</td> <td>L/net</td> <td>⚡</td> <td>🔌</td> <td>📊</td> <td>🔄</td> <td>🧊</td> <td>📊</td> <td>📊</td> </tr> <tr> <td>0/+10</td> <td>250</td> <td>320 W</td> <td>230 V / 50 Hz</td> <td>2,35 kWh</td> <td>24h</td> <td>auto</td> <td>kg/net</td> <td>kg/br</td> </tr> <tr> <td></td> <td></td> <td></td> <td></td> <td></td> <td></td> <td></td> <td>89</td> <td>111</td> </tr> </table>	°C	L/net	⚡	🔌	📊	🔄	🧊	📊	📊	0/+10	250	320 W	230 V / 50 Hz	2,35 kWh	24h	auto	kg/net	kg/br								89	111		
°C	L/net	⚡	🔌	📊	🔄	🧊	📊	📊																						
0/+10	250	320 W	230 V / 50 Hz	2,35 kWh	24h	auto	kg/net	kg/br																						
							89	111																						
<p>Nutzhöhe Schubladen: 315 mm</p> 	<p>Flaschenkühltisch 350 Liter, 1 Tür, 2 Schubladen, schwarz</p> <ul style="list-style-type: none"> · 1462 x 513 x 860 mm · Innenmaß: 1082 x 415 x 760 mm · Temperatur: 0°C/+10°C · Umluftkühlung · 320 W, 230 V, 50 Hz · Verbrauch: 3,02 kWh/24h · automatische Abtauung · abschließbar · inkl. 4 höhenverstellbare Roste: 430 x 395 mm · Verpackungsmaß: 1522 x 575 x 1000 mm 	<p>BBC220.01</p>  	<p>2.149,00</p>																											
	<table border="1"> <tr> <td>°C</td> <td>L/net</td> <td>⚡</td> <td>🔌</td> <td>📊</td> <td>🔄</td> <td>🧊</td> <td>📊</td> <td>📊</td> </tr> <tr> <td>0/+10</td> <td>233</td> <td>320 W</td> <td>230 V / 50 Hz</td> <td>3,02 kWh</td> <td>24h</td> <td>auto</td> <td>kg/net</td> <td>kg/br</td> </tr> <tr> <td></td> <td></td> <td></td> <td></td> <td></td> <td></td> <td></td> <td>99</td> <td>120</td> </tr> </table>	°C	L/net	⚡	🔌	📊	🔄	🧊	📊	📊	0/+10	233	320 W	230 V / 50 Hz	3,02 kWh	24h	auto	kg/net	kg/br								99	120		
°C	L/net	⚡	🔌	📊	🔄	🧊	📊	📊																						
0/+10	233	320 W	230 V / 50 Hz	3,02 kWh	24h	auto	kg/net	kg/br																						
							99	120																						
<p>Nutzhöhe Schubladen: 315 mm</p> 	<p>Flaschenkühltisch 350 Liter, 4 Schubladen, schwarz</p> <ul style="list-style-type: none"> · 1462 x 513 x 860 mm · Innenmaß: 1082 x 415 x 760 mm · Temperatur: 0°C/+10°C · Umluftkühlung · 320 W, 230 V, 50 Hz · Verbrauch: 2,9 kWh/24h · automatische Abtauung · abschließbar · Verpackungsmaß: 1522 x 575 x 1000 mm 	<p>BBC240.01</p>  	<p>2.529,00</p>																											
	<table border="1"> <tr> <td>°C</td> <td>L/net</td> <td>⚡</td> <td>🔌</td> <td>📊</td> <td>🔄</td> <td>🧊</td> <td>📊</td> <td>📊</td> </tr> <tr> <td>0/+10</td> <td>211</td> <td>320 W</td> <td>230 V / 50 Hz</td> <td>2,9 kWh</td> <td>24h</td> <td>auto</td> <td>kg/net</td> <td>kg/br</td> </tr> <tr> <td></td> <td></td> <td></td> <td></td> <td></td> <td></td> <td></td> <td>109</td> <td>130</td> </tr> </table>	°C	L/net	⚡	🔌	📊	🔄	🧊	📊	📊	0/+10	211	320 W	230 V / 50 Hz	2,9 kWh	24h	auto	kg/net	kg/br								109	130		
°C	L/net	⚡	🔌	📊	🔄	🧊	📊	📊																						
0/+10	211	320 W	230 V / 50 Hz	2,9 kWh	24h	auto	kg/net	kg/br																						
							109	130																						
	<p>Flaschenkühltisch 537 Liter, 3 Türen, schwarz</p> <ul style="list-style-type: none"> · 2002 x 513 x 860 mm · Innenmaß: 1622 x 415 x 760 mm · Temperatur: 0°C/+10°C · Umluftkühlung · 320 W, 230 V, 50 Hz · Verbrauch: 2,85 kWh/24h · automatische Abtauung, abschließbar · inkl. 8 höhenverstellbare Roste: 6x 430 x 395 mm 2x 95 x 335 mm · Verpackungsmaß: 2062 x 575 x 1000 mm 	<p>BBC310.01</p>  	<p>1.899,00</p>																											
	<table border="1"> <tr> <td>°C</td> <td>L/net</td> <td>⚡</td> <td>🔌</td> <td>📊</td> <td>🔄</td> <td>🧊</td> <td>📊</td> <td>📊</td> </tr> <tr> <td>0/+10</td> <td>386</td> <td>320 W</td> <td>230 V / 50 Hz</td> <td>2,85 kWh</td> <td>24h</td> <td>auto</td> <td>kg/net</td> <td>kg/br</td> </tr> <tr> <td></td> <td></td> <td></td> <td></td> <td></td> <td></td> <td></td> <td>106</td> <td>142</td> </tr> </table>	°C	L/net	⚡	🔌	📊	🔄	🧊	📊	📊	0/+10	386	320 W	230 V / 50 Hz	2,85 kWh	24h	auto	kg/net	kg/br								106	142		
°C	L/net	⚡	🔌	📊	🔄	🧊	📊	📊																						
0/+10	386	320 W	230 V / 50 Hz	2,85 kWh	24h	auto	kg/net	kg/br																						
							106	142																						

Flaschenkühltische

	Artikel	Code	Euro
<p>Nutzhöhe Schubladen: 315 mm</p> 	<p>Flaschenkühltisch 537 Liter, 2 Türen, 2 Schubladen, schwarz</p> <ul style="list-style-type: none"> · 2002 x 513 x 860 mm · Innenmaß: 1622 x 415 x 760 mm · Temperatur: 0°C/+10°C · 320 W, 230 V, 50 Hz · Verbrauch: 3,05 kWh/24h · automatische Abtauung · abschließbar · inkl. 6 höhenverstellbare Roste: 4x 430 x 395 mm 2x 95 x 335 mm · Verpackungsmaß: 2062 x 575 x 1000 mm 	<p>BBC320.01</p>  	<p>2.379,00</p>
<p>Nutzhöhe Schubladen: 315 mm</p> 	<p>Flaschenkühltisch 537 Liter, 1 Tür, 2 Schubladen, schwarz</p> <ul style="list-style-type: none"> · 2002 x 513 x 860 mm · Innenmaß: 1622 x 415 x 760 mm · Temperatur: 0°C/+10°C · Umluftkühlung · 320 W, 230 V, 50 Hz · Verbrauch: 3,24 kWh/24h · automatische Abtauung, abschließbar · inkl. 3 höhenverstellbare Roste: 2x 430 x 395 mm 1x 95 x 335 mm · Verpackungsmaß: 2062 x 575 x 1000 mm 	<p>BBC340.01</p>  	<p>2.929,00</p>
<p>Nutzhöhe Schubladen: 315 mm</p> 	<p>Flaschenkühltisch 537 Liter, 6 Schubladen, schwarz</p> <ul style="list-style-type: none"> · 2002 x 513 x 860 mm · Innenmaß: 1622 x 415 x 760 mm · Temperatur: 0°C/+10°C · Umluftkühlung · 320 W, 230 V, 50 Hz · Verbrauch: 3,56 kWh/24h · automatische Abtauung · abschließbar · Verpackungsmaß: 2062 x 575 x 1000 mm 	<p>BBC360.01</p>  	<p>3.479,00</p>
	<p>Flaschenkühltisch 698 Liter, 4 Türen, schwarz</p> <ul style="list-style-type: none"> · 2542 x 513 x 860 mm · Innenmaß: 2162 x 415 x 760 mm · Temperatur: 0°C/+10°C · Umluftkühlung · 320 W, 230 V, 50 Hz · Verbrauch: 3,18 kWh/24h · automatische Abtauung, abschließbar · inkl. 12 höhenverstellbare Roste: 8x 430 x 395 mm 4x 96 x 335 mm · Verpackungsmaß: 2062 x 575 x 1000 mm 	<p>BBC410.01</p>  	<p>2.229,00</p>













°C 0/+10	L/net 372	⚡ 320 W	🔌 230 V / 50 Hz	📊 3,05 kWh	🔄 24h	❄️ auto	📦 kg/net 116	📦 kg/br 149
-------------	--------------	------------	--------------------	---------------	----------	------------	--------------------	-------------------

°C 0/+10	L/net 347	⚡ 320 W	🔌 230 V / 50 Hz	📊 3,24 kWh	🔄 24h	❄️ auto	📦 kg/net 126	📦 kg/br 159
-------------	--------------	------------	--------------------	---------------	----------	------------	--------------------	-------------------

°C 0/+10	L/net 316	⚡ 320 W	🔌 230 V / 50 Hz	📊 3,56 kWh	🔄 24h	❄️ auto	📦 kg/net 136	📦 kg/br 169
-------------	--------------	------------	--------------------	---------------	----------	------------	--------------------	-------------------

°C 0/+10	L/net 518	⚡ 320 W	🔌 230 V / 50 Hz	📊 3,18 kWh	🔄 24h	❄️ auto	📦 kg/net 152	📦 kg/br 172
-------------	--------------	------------	--------------------	---------------	----------	------------	--------------------	-------------------

Flaschenkühltische

	Artikel	Code	Euro																
<p>Nutzhöhe Schubladen: 315 mm</p> 	<p>Flaschenkühltisch 698 Liter, schwarz, 3 Türen, 2 Schubladen</p> <ul style="list-style-type: none"> · 2542 x 513 x 860 mm · Innenmaß: 2162 x 415 x 760 mm · Temperatur: 0°C/+10°C · 320 W, 230 V, 50 Hz · Verbrauch: 4,05 kWh/24h · manuelle Abtauung · inkl. 8 höhenverstellbare Böden: 6x 430 x 395 mm 2x 96 x 335 mm 	<p>BBC420.01</p>  	<p>2.899,00</p>																
<table border="1"> <tr> <td>°C</td> <td>L/net</td> <td>⚡</td> <td>🔌</td> <td>📊</td> <td>man</td> <td>kg/net</td> <td>kg/br</td> </tr> <tr> <td>0/+10</td> <td>495</td> <td>320 W</td> <td>230 V / 50 Hz</td> <td>4,05 kWh</td> <td>☃️</td> <td>158</td> <td>178</td> </tr> </table>				°C	L/net	⚡	🔌	📊	man	kg/net	kg/br	0/+10	495	320 W	230 V / 50 Hz	4,05 kWh	☃️	158	178
°C	L/net	⚡	🔌	📊	man	kg/net	kg/br												
0/+10	495	320 W	230 V / 50 Hz	4,05 kWh	☃️	158	178												
<p>Nutzhöhe Schubladen: 315 mm</p> 	<p>Flaschenkühltisch 698 Liter, schwarz, 2 Türen, 4 Schubladen</p> <ul style="list-style-type: none"> · 2542 x 513 x 860 mm · Innenmaß: 2162 x 415 x 760 mm · Temperatur: 0°C/+10°C · 320 W, 230 V, 50 Hz · Verbrauch: 4,09 kWh/24h · manuelle Abtauung · inkl. 6 höhenverstellbare Böden: 4x 430 x 395 mm 2x 96 x 335 mm 	<p>BBC440.01</p>  	<p>3.479,00</p>																
<table border="1"> <tr> <td>°C</td> <td>L/net</td> <td>⚡</td> <td>🔌</td> <td>📊</td> <td>man</td> <td>kg/net</td> <td>kg/br</td> </tr> <tr> <td>0/+10</td> <td>478</td> <td>320 W</td> <td>230 V / 50 Hz</td> <td>4,09 kWh</td> <td>☃️</td> <td>164</td> <td>184</td> </tr> </table>				°C	L/net	⚡	🔌	📊	man	kg/net	kg/br	0/+10	478	320 W	230 V / 50 Hz	4,09 kWh	☃️	164	184
°C	L/net	⚡	🔌	📊	man	kg/net	kg/br												
0/+10	478	320 W	230 V / 50 Hz	4,09 kWh	☃️	164	184												
<p>Nutzhöhe Schubladen: 315 mm</p> 	<p>Flaschenkühltisch 698 Liter, schwarz, 1 Türen, 6 Schubladen</p> <ul style="list-style-type: none"> · 2542 x 513 x 860 mm · Innenmaß: 2162 x 415 x 760 mm · Temperatur: 0°C/+10°C · 320 W, 230 V, 50 Hz · Verbrauch: 3,9 kWh/24h · manuelle Abtauung · inkl. 2 höhenverstellbare Böden: 6x 430 x 395 mm 	<p>BBC460.01</p>  	<p>4.059,00</p>																
<table border="1"> <tr> <td>°C</td> <td>L/net</td> <td>⚡</td> <td>🔌</td> <td>📊</td> <td>man</td> <td>kg/net</td> <td>kg/br</td> </tr> <tr> <td>0/+10</td> <td>432</td> <td>320 W</td> <td>230 V / 50 Hz</td> <td>3,9 kWh</td> <td>☃️</td> <td>168</td> <td>188</td> </tr> </table>				°C	L/net	⚡	🔌	📊	man	kg/net	kg/br	0/+10	432	320 W	230 V / 50 Hz	3,9 kWh	☃️	168	188
°C	L/net	⚡	🔌	📊	man	kg/net	kg/br												
0/+10	432	320 W	230 V / 50 Hz	3,9 kWh	☃️	168	188												
<p>Nutzhöhe Schubladen: 315 mm</p> 	<p>Flaschenkühltisch 698 Liter, schwarz, 8 Schubladen</p> <ul style="list-style-type: none"> · 2542 x 513 x 860 mm · Innenmaß: 2162 x 415 x 760 mm · Temperatur: 0°C/+10°C · 320 W, 230 V, 50 Hz · Verbrauch: 3,31 kWh/24h · manuelle Abtauung · inkl. 8 höhenverstellbare Böden 	<p>BBC480.01</p>  	<p>4.629,00</p>																
<table border="1"> <tr> <td>°C</td> <td>L/net</td> <td>⚡</td> <td>🔌</td> <td>📊</td> <td>man</td> <td>kg/net</td> <td>kg/br</td> </tr> <tr> <td>0/+10</td> <td>425</td> <td>320 W</td> <td>230 V / 50 Hz</td> <td>3,31 kWh</td> <td>☃️</td> <td>168</td> <td>188</td> </tr> </table>				°C	L/net	⚡	🔌	📊	man	kg/net	kg/br	0/+10	425	320 W	230 V / 50 Hz	3,31 kWh	☃️	168	188
°C	L/net	⚡	🔌	📊	man	kg/net	kg/br												
0/+10	425	320 W	230 V / 50 Hz	3,31 kWh	☃️	168	188												

Fasskühler



Fasskühler

- für max 50 L Fässer, verstärkter Edelstahlboden
- Paneele befestigt mit Haken für schnellen Einbau
- höhenverstellbare FüÙe, PU-Schaum Isolierung 40 mm
- einfacher Zugang für Reinigung und Wartung



leicht entfernbare magnetische Dichtung













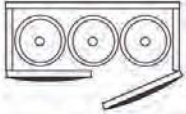
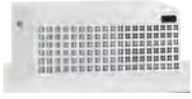

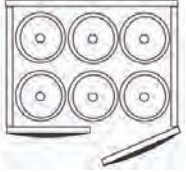
Türen mit ergonomischen Griffen

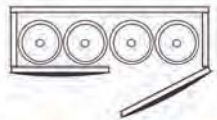

Edelstahlboden

	Artikel	Code	Euro
	2x 1 50 L/2x 2 30 L Fässer · 1060 x 730 x 1060 mm 	10401201	819,00
	Monoblock Kühlanlage · 675 x 495 x 305 mm · Temperatur: +2°C/+8°C · 280 W, 230 V, 50 Hz 	10402201	729,00
	2x 2 50 L/2x 4 30 L Fässer · 1060 x 995 x 1060 mm 	10401202	929,00
	Monoblock Kühlanlage · 675 x 495 x 305 mm · Temperatur: +2°C/+8°C · 280 W, 230 V, 50 Hz 	10402201	729,00

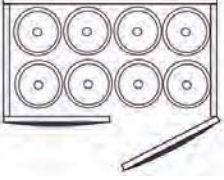
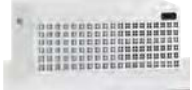
Fasskühler

	Artikel	Code	Euro
	3x 1 50 L/3x 2 30 L Fässer · 1465 x 730 x 1060 mm 	10401203	989,00
	Monoblock Kühlanlage · 675 x 495 x 305 mm · Temperatur: +2°C/+8°C · 280 W, 230 V, 50 Hz 		10402201
	3x 2 50 L/3x 4 30 L Fässer · 1465 x 995 x 1060 mm 	10401204	1.179,00
	Monoblock Kühlanlage · 675 x 495 x 305 mm · Temperatur: +2°C/+8°C · 360 W, 230 V, 50 Hz 		10402202
	4x 1 50 L/4x 2 30 L Fässer · 1870 x 730 x 1060 mm 	10401205	1.229,00
	Monoblock Kühlanlage · 675 x 495 x 305 mm · Temperatur: +2°C/+8°C · 360 W, 230 V, 50 Hz 		10402202
	4x 2 50 L/4x 4 30 L Fässer · 1870 x 995 x 1060 mm 	10401206	1.379,00
	Monoblock Kühlanlage · 675 x 495 x 305 mm · Temperatur: +2°C/+8°C · 360 W, 230 V, 50 Hz 		10402202

Servier-/Transportwagen

	Artikel	Code	Euro				
	Servier-/ Transportwagen 2 Borde <ul style="list-style-type: none"> · 860 x 535 x 940 mm · Chromnickelstahl · 4 Lenkrollen mit 2 Feststellern · Tragfähigkeit: 80 kg 	TROLL2	89,00				
	<table border="0"> <tr> <td> kg /net</td> <td> kg /br</td> </tr> <tr> <td>9,86</td> <td>11,3</td> </tr> </table>	 kg /net	 kg /br	9,86	11,3		
 kg /net	 kg /br						
9,86	11,3						
	Servier-/ Transportwagen 3 Borde <ul style="list-style-type: none"> · 860 x 535 x 940 mm · Chromnickelstahl · 4 Lenkrollen mit 2 Feststellern · Tragfähigkeit: 120 kg 	TROLL3	99,00				
	<table border="0"> <tr> <td> kg /net</td> <td> kg /br</td> </tr> <tr> <td>13</td> <td>14</td> </tr> </table>	 kg /net	 kg /br	13	14		
 kg /net	 kg /br						
13	14						
	Servier-/ Transportwagen 4 Borde <ul style="list-style-type: none"> · 855 x 535 x 1275 mm · Chromnickelstahl · 4 Lenkrollen mit 2 Feststellern 	TROLLY4	169,00				
	<table border="0"> <tr> <td> kg /net</td> <td> kg /br</td> </tr> <tr> <td>17</td> <td>17,99</td> </tr> </table>	 kg /net	 kg /br	17	17,99		
 kg /net	 kg /br						
17	17,99						
	Servier-/ Transportwagen 5 Borde <ul style="list-style-type: none"> · 855 x 535 x 1275 mm · Chromnickelstahl · 4 Lenkrollen mit 2 Feststellern · Verpackungsmaß: 940 x 530 x 200 mm 	TROLLEY5	199,00				
	<table border="0"> <tr> <td> kg /net</td> <td> kg /br</td> </tr> <tr> <td>14,58</td> <td>15,86</td> </tr> </table>	 kg /net	 kg /br	14,58	15,86		
 kg /net	 kg /br						
14,58	15,86						

Kühlvitrienen











6







Kühlvitrienen

Aufsatzgetränk Kühler	96 - 98
Sushi- & Tapas-Theken	99
Kühl-Schauvitrienen	100 - 101
Heiße und Kalte Theken	102 - 104
GastroLine	105 - 107
Gastro Buffet kalt & heiß	108 - 111

Aufsatzgetränkekühler

	Artikel	Code	Euro
	Aufsatzgetränkekühler 58 Liter, weiß <ul style="list-style-type: none"> · 428 x 386 x 846 mm · Innenmaß: 400 x 358 x 460 mm · Temperatur: +3°C/+8°C · Umluftkühlung, automatische Abtauung · 160 W, 230 V, 50 Hz · LED-Beleuchtung · FCKW-freies Kältemittel · belüftetes Kühlfach für eine bessere Luftzirkulation · elektronisches Thermostat · digitale LED-Temperaturanzeige · inkl. 2 verstellbare Roste à 336 x 335 mm 	58.01TC 	419,00
	NEU Aufsatzgetränkekühler 58 Liter Netto, schwarz <ul style="list-style-type: none"> · 428 x 386 x 810 mm, 4 Seiten verglast · Temperatur: 0°C/+12°C, Kältemittel: R600a · Umluftkühlung, automatische Abtauung · Klimaklasse: 4 bzw. N · 180 W, 230 V, 50 Hz · digitale Steuerung · LED Innenbeleuchtung, Doppelverglasung · inkl. 2 verstellbare, kunststoffummantelte Roste · Verpackungsmaß: 475 x 462 x 888 mm 	58BB 	349,00
	NEU Aufsatzgetränkekühler 68 Liter Netto, weiß <ul style="list-style-type: none"> · 428 x 386 x 885 mm, 4 Seiten verglast · Temperatur: 0°C/+12°C, Kältemittel: R600a · Umluftkühlung, automatische Abtauung · Klimaklasse: 4 bzw. N · 180 W, 230 V, 50 Hz · digitale Steuerung · LED Innenbeleuchtung, Doppelverglasung · inkl. 3 verstellbare, kunststoffummantelte Roste · Verpackungsmaß: 475 x 462 x 953 mm 	72L 	399,00
	NEU Aufsatzgetränkekühler 68 Liter Netto, schwarz <ul style="list-style-type: none"> · 428 x 386 x 885 mm, 4 Seiten verglast · Temperatur: 0°C/+12°C, Kältemittel: R600a · Umluftkühlung, automatische Abtauung · Klimaklasse: 4 bzw. N · 180 W, 230 V, 50 Hz · digitale Steuerung · LED Innenbeleuchtung, Doppelverglasung · inkl. 3 verstellbare, kunststoffummantelte Roste · Verpackungsmaß: 475 x 462 x 953 mm 	72BB 	399,00

Aufsatzgetränkekühler

	Artikel	Code	Euro
	Aufsatzgetränkekühler 68 Liter, weiß <ul style="list-style-type: none"> · 428 x 386 x 924 mm · Innenmaß: 400 x 358 x 535 mm · Temperatur: +3°C/+8°C · Umluftkühlung, automatische Abtaung · 164 W, 230 V, 50 Hz · LED-Beleuchtung · FCKW-freies Kältemittel · belüftetes Kühlfach für eine bessere Luftzirkulation · elektronisches Thermostat · digitale LED-Temperaturanzeige · inkl. 3 verstellbare Roste à 336 x 335 mm 	68TC	459,00
	wie oben, nur in schwarz	68BB	489,00
			
	Aufsatzgetränkekühler 98 Liter Netto, schwarz <ul style="list-style-type: none"> · 428 x 386 x 1100 mm, 4 Seiten verglast · Temperatur: 0°C/+12°C, Kältemittel: R600a · Umluftkühlung, automatische Abtaung · Klimaklasse: 4 bzw. N · 180 W, 230 V, 50 Hz · digitale Steuerung · LED Innenbeleuchtung, Doppelverglasung · inkl. 4 verstellbare, kunststoffummantelte Roste · Verpackungsmaß: 475 x 462 x 1180 mm 	98BB 	429,00
	NEU		
			
	Aufsatzgetränkekühler 98 Liter, weiß <ul style="list-style-type: none"> · 428 x 386 x 1150 mm · Innenmaß: 400 x 358 x 760 mm · Temperatur: +3°C/+8°C · Umluftkühlung · automatische Abtaung · 200 W, 230 V, 50 Hz · LED-Beleuchtung · FCKW-freies Kältemittel · belüftetes Kühlfach für eine bessere Luftzirkulation · elektronisches Thermostat · digitale LED-Temperaturanzeige · inkl. 4 verstellbare Roste à 336 x 335 mm 	98TC	559,00
	wie oben, nur in schwarz	98TCBB	579,00
			

























Getränke- & Kuchenvitrinen

	Artikel	Code	Euro														
	Getränke- & Kuchenvitrine 220 Liter, weiß <ul style="list-style-type: none"> · 515 x 485 x 1642 mm · Innenmaß: 473 x 408 x 1138 mm · Temperatur: +3°C/+8°C · Umluftkühlung · automatische Abtauung · 240 W, 230 V, 50 Hz · LED-Beleuchtung · inkl. 3 verstellbare Roste à 411 x 404 mm · Verpackungsmaß: 575 x 545 x 1773 mm 	LSC235  Kältemittel: R600a	1.399,00														
	wie oben, nur in schwarz	LSC235 black.01	1.469,00														
<table border="0"> <tr> <td>°C</td> <td>L/net</td> <td>⚡</td> <td>230 V / 50 Hz</td> <td>auto</td> <td>kg/net</td> <td>kg/br</td> </tr> <tr> <td>+3/+8</td> <td>184</td> <td>240 W</td> <td></td> <td></td> <td>83</td> <td>90</td> </tr> </table>				°C	L/net	⚡	230 V / 50 Hz	auto	kg/net	kg/br	+3/+8	184	240 W			83	90
°C	L/net	⚡	230 V / 50 Hz	auto	kg/net	kg/br											
+3/+8	184	240 W			83	90											
	Getränke- & Kuchenvitrine 258 Liter, weiß <ul style="list-style-type: none"> · 515 x 485 x 1842 mm · Innenmaß: 473 x 408 x 1338 mm · Temperatur: +2°C/+8°C · Umluftkühlung · automatische Abtauung · 240 W, 230 V, 50 Hz · LED-Beleuchtung · inkl. 3 verstellbare Roste à 411 x 404 mm · Verpackungsmaß: 575 x 545 x 1973 mm 	LSC280  Kältemittel: R600a	1.419,00														
	wie oben, nur in schwarz	LSC280 black.01	1.499,00														
<table border="0"> <tr> <td>°C</td> <td>L/net</td> <td>⚡</td> <td>230 V / 50 Hz</td> <td>auto</td> <td>kg/net</td> <td>kg/br</td> </tr> <tr> <td>+2/+8</td> <td>217</td> <td>240 W</td> <td></td> <td></td> <td>107</td> <td>120</td> </tr> </table>				°C	L/net	⚡	230 V / 50 Hz	auto	kg/net	kg/br	+2/+8	217	240 W			107	120
°C	L/net	⚡	230 V / 50 Hz	auto	kg/net	kg/br											
+2/+8	217	240 W			107	120											
	Kuchenvitrine 167 Liter <ul style="list-style-type: none"> · 1300 x 706 x 706 mm · Innen: 578 x 638 x 632 mm · 220 W, 230 V, 50 Hz · Temperatur: +2°C bis +10°C · inkl. 2 Böden · Umluftkühlung · automatische Abtauung · LED-Beleuchtung 	KVC260.01	1.279,00														
	<table border="0"> <tr> <td>°C</td> <td>L/net</td> <td>⚡</td> <td>230 V / 50 Hz</td> <td>auto</td> <td>kg/net</td> <td>kg/br</td> </tr> <tr> <td>+2/+10</td> <td>167</td> <td>220 W</td> <td></td> <td></td> <td>163</td> <td>173</td> </tr> </table>				°C	L/net	⚡	230 V / 50 Hz	auto	kg/net	kg/br	+2/+10	167	220 W			163
°C	L/net	⚡	230 V / 50 Hz	auto	kg/net	kg/br											
+2/+10	167	220 W			163	173											
	Kuchenvitrine 290 Liter <ul style="list-style-type: none"> · 1800 x 706 x 706 mm · Innen: 1180 x 638 x 632 mm · 280 W, 230 V, 50 Hz · Temperatur: +2°C bis +10°C · inkl. 4 Böden · Umluftkühlung · automatische Abtauung · LED-Beleuchtung 	KVC460.01	2.119,00														
	<table border="0"> <tr> <td>°C</td> <td>L/net</td> <td>⚡</td> <td>230 V / 50 Hz</td> <td>auto</td> <td>kg/net</td> <td>kg/br</td> </tr> <tr> <td>+2/+10</td> <td>290</td> <td>280 W</td> <td></td> <td></td> <td>172</td> <td>182</td> </tr> </table>				°C	L/net	⚡	230 V / 50 Hz	auto	kg/net	kg/br	+2/+10	290	280 W			172
°C	L/net	⚡	230 V / 50 Hz	auto	kg/net	kg/br											
+2/+10	290	280 W			172	182											

























Sushi Theken / Tapas Theken

	Artikel	Code	Euro	
 <p>0°C/+6°C</p> <p>NEU</p>	Sushi Theke I schwarz - GN 1/3-30 · Temperatur: 0°C/+6°C · statische Kühlung, manuelle Abtauung · 230 V, 50 Hz, mit LED Beleuchtung · Ober- & Unterseiten Verdampfer · beheizte und abnehmbare Frontscheibe · inkl. GN-Behälter	 <p>Kältemittel: R600a</p>		
	1200 x 390 x 290 mm 43,80 Liter , 4x 1/3 GN, 140 W, Gewicht: 46 kg/65 kg		ST-1200	999,00
	1500 x 390 x 290 mm 59,70 Liter , 5x 1/3 GN, 144 W, Gewicht: 51 kg/74 kg		ST-1500	1.169,00
	1800 x 390 x 290 mm 76,60 Liter , 7x 1/3 GN, 149 W, Gewicht: 61 kg/85 kg		ST-1800	1.299,00
	2000 x 390 x 290 mm 90,23 Liter , 8x 1/3 GN, 176 W, Gewicht: 71 kg/91 kg		ST-2000	1.459,00
	GN 1/3 °C 0/+6 230 V / 50 Hz man			
 <p>0°C/+8°C</p> <p>NEU</p>	Tapas Theke I schwarz - GN 1/3-30 · Temperatur: 0°C/+8°C · statische Kühlung, manuelle Abtauung · 230 V, 50 Hz, mit LED Beleuchtung · Ober- & Unterseiten Verdampfer · beheizte und abnehmbare Frontscheibe · inkl. GN-Behälter	 <p>Kältemittel: R600a</p>		
	1200 x 390 x 290 mm 43,80 Liter , 4x 1/3 GN, 120 W, Gewicht: 44 kg/60 kg		TT-1200	919,00
	1500 x 390 x 290 mm 59,70 Liter , 5x 1/3 GN, 122 W, Gewicht: 49 kg/69 kg		TT-1500	1.049,00
	1800 x 390 x 290 mm 76,60 Liter , 7x 1/3 GN, 160 W, Gewicht: 59 kg/79 kg		TT-1800	1.179,00
	2000 x 390 x 290 mm 90,23 Liter , 8x 1/3 GN, 160 W, Gewicht: 69 kg/89 kg		TT-2000	1.459,00
	GN 1/3 °C 0/+8 230 V / 50 Hz man			
 <p>mit Glasablage</p> <p>NEU</p>	Tapas Theke I schwarz - GN 1/3-30 mit Glasablage · Temperatur: 0°C/+8°C · statische Kühlung, manuelle Abtauung · 230 V, 50 Hz, mit LED Beleuchtung · Ober- & Unterseiten Verdampfer · beheizte und abnehmbare Frontscheibe, inkl. GN-Behälter	 <p>Kältemittel: R600a</p>		
	1200 x 390 x 290 mm 43,80 Liter , 4x 1/3 GN, 120 W, Gewicht: 44 kg/60 kg		TT2-1200	959,00
	1500 x 390 x 290 mm 59,70 Liter , 5x 1/3 GN, 122 W, Gewicht: 49 kg/69 kg		TT2-1500	1.099,00
	1800 x 390 x 290 mm 76,60 Liter , 7x 1/3 GN, 160 W, Gewicht: 59 kg/79 kg		TT2-1800	1.239,00
	2000 x 390 x 290 mm 90,23 Liter , 8x 1/3 GN, 160 W, Gewicht: 69 kg/89 kg		TT2-2000	1.389,00
	GN 1/3 °C 0/+8 230 V / 50 Hz man			

Kühl-Schauvitrienen

	Artikel	Code	Euro
	<p>Kühl-Schauvitrine 101 Liter</p> <ul style="list-style-type: none"> · 805 x 410 x 720 mm · Innenmaß: 775 x 348 x 375 mm · Temperatur: +3°C/+8°C · Umluftkühlung · automatische Abtauung · 165 W, 230 V, 50 Hz · Sicherheitsglas · elektrische Temperaturkontrolle · Eck-LED Beleuchtung · Einschübe in 10 mm Abständen · inkl. 1 Rost à 768 x 319 mm · Verpackungsmaß: 845 x 450 x 750 mm 	<p>AKO96.01</p> 	<p>1.469,00</p>
	     		
	<p>Kühl-Schauvitrine 160 Liter</p> <ul style="list-style-type: none"> · 805 x 410 x 940 mm · Innenmaß: 775 x 348 x 595 mm · Temperatur: +3°C/+8°C · Umluftkühlung · automatische Abtauung · 165 W, 230 V, 50 Hz · Sicherheitsglas · elektrische Temperaturkontrolle · Eck-LED Beleuchtung · Einschübe in 10 mm Abständen · inkl. 1 Rost à 768 x 319 mm · Verpackungsmaß: 865 x 470 x 1157 mm 	<p>AKO162.01</p> 	<p>1.599,00</p>
	     		
	<p>Kühl-Schauvitrine 201 Liter</p> <ul style="list-style-type: none"> · 1005 x 410 x 940 mm · Innenmaß: 975 x 348 x 595 mm · Temperatur: +3°C/+8°C · Umluftkühlung · automatische Abtauung · 210 W, 230 V, 50 Hz · Sicherheitsglas · elektrische Temperaturkontrolle · Eck-LED Beleuchtung · Einschübe in 10 mm Abständen · inkl. 1 Rost à 968 x 319 mm · Verpackungsmaß: 1065 x 470 x 1157 mm 	<p>AKO204.01</p> 	<p>1.779,00</p>
	     		

Kühl-Schauvitrinen

	Artikel	Code	Euro
	<p>Kühl-Schauvitrine 110 Liter</p> <ul style="list-style-type: none"> · 910 x 510 x 550 mm · Innenmaß: 574 x 418 x 460 mm · Temperatur: +3°C/+8°C · 180 W, 230 V, 50 Hz · Umluftkühlung, manuelle Abtauung · Sicherheitsglas · elektrische Temperaturkontrolle · Eck-LED Beleuchtung · Einschübe 10 mm Abstand · Traglast der Roste 25 kg · inkl. 1 Rost à 946 x 390 mm · Verpackungsmaß: 970 x 570 x 640 mm 	<p>AKV91.01</p> 	<p>1.259,00</p>
	     		
	<p>Kühl-Schauvitrine 150 Liter</p> <ul style="list-style-type: none"> · 1110 x 510 x 550 mm · Innenmaß: 774 x 418 x 460 mm · Temperatur: +3°C/+8°C · 180 W, 230 V, 50 Hz · Umluftkühlung, manuelle Abtauung · Sicherheitsglas · elektrische Temperaturkontrolle · Eck-LED Beleuchtung · Einschübe 10 mm Abstand · Traglast der Roste 25 kg · inkl. 1 Rost à 552 x 390 mm · Verpackungsmaß: 1170 x 570 x 640 mm 	<p>AKV111.01</p> 	<p>1.399,00</p>
	     		
	<p>Kühl-Schauvitrine 190 Liter</p> <ul style="list-style-type: none"> · 1310 x 510 x 550 mm · Innenmaß: 974 x 418 x 460 mm · Temperatur: +3°C/+8°C · 180 W, 230 V, 50 Hz · Umluftkühlung, manuelle Abtauung · Sicherheitsglas · elektrische Temperaturkontrolle · Eck-LED Beleuchtung · Einschübe 10 mm Abstand · Traglast der Roste 25 kg · inkl. 1 Rost à 752 x 390 mm · Verpackungsmaß: 1370 x 570 x 640 mm 	<p>AKV131.01</p> 	<p>1.539,00</p>
	     		

Heiße Theken

	Artikel	Code	Euro
	Heiße Theke <ul style="list-style-type: none"> · Temperatur: +30°C/+90°C · 230 V, 50 Hz · manuelles Thermostat · PTC Heizer mit Umluftheizung, · Glas-Schiebetüren hinten · Edelstahl Korpus · LED-Beleuchtung, Wasserschale · inkl. Chrom-Roste 		

Abmessungen	Ausstellflächen	Roste	Volumen	Leistung	Gewicht	Verpackung		
695 x 462 x 670 mm	1x 642 x 276 mm 1x 642 x 312 mm	1x 642 x 272 mm 1x 642 x 308 mm 2x 324 x 360 mm	85 Liter	800 W	57 kg/62 kg	810 x 532 x 740 mm	HTH100	619,00
695 x 580 x 670 mm	1x 642 x 376 mm 1x 642 x 412 mm	1x 642 x 372 mm 1x 642 x 408 mm 2x 324 x 478 mm	115 Liter	800 W	70 kg/75 kg	810 x 650 x 740 mm	HTH120	629,00
873 x 580 x 670 mm	1x 820 x 372 mm 1x 820 x 408 mm	1x 820 x 372 mm 1x 820 x 408 mm 2x 409 x 478 mm	146 Liter	1500 W	80 kg/85 kg	990 x 650 x 740 mm	HTH160	719,00

 610 mm Höhe	Heiße Theke 95 Liter, 2x GN 1/1, beheizbar, Edelstahl <ul style="list-style-type: none"> · 800 x 770 x 610 (+/- 10) mm · Temperatur: +40°C/+90°C · Ablagegewicht: 3 kg · 1800 W, 230 V, 50 Hz · rostfrei und säure-beständig, zusätzliche Ablage · mit Beleuchtung · Verpackungsmaß: 1000 x 950 x 800 mm 	CELINA80	1.579,00						
<table border="1"> <tr> <td>GN 2x 1/1</td> <td>°C +40/+90</td> <td>⚡ 1800 W</td> <td>🔌 230 V/ 50 Hz</td> <td>📦/net 40</td> <td>📦/br 70</td> </tr> </table>		GN 2x 1/1	°C +40/+90	⚡ 1800 W	🔌 230 V/ 50 Hz	📦/net 40	📦/br 70		
GN 2x 1/1	°C +40/+90	⚡ 1800 W	🔌 230 V/ 50 Hz	📦/net 40	📦/br 70				

 610 mm Höhe	Heiße Theke 155 Liter, 3x GN 1/1, beheizbar, Edelstahl <ul style="list-style-type: none"> · 1330 x 770 x 610 (+/- 10) mm · Temperatur: +40°C/+90°C · Ablagegewicht: 3 kg · 1800 W, 230 V, 50 Hz · rostfrei und säure-beständig, zusätzliche Ablage · mit Beleuchtung · Verpackungsmaß: 1500 x 950 x 800 mm 	CELINA130	2.079,00						
<table border="1"> <tr> <td>GN 3x 1/1</td> <td>°C +40/+90</td> <td>⚡ 1800 W</td> <td>🔌 230 V/ 50 Hz</td> <td>📦/net 60</td> <td>📦/br 100</td> </tr> </table>		GN 3x 1/1	°C +40/+90	⚡ 1800 W	🔌 230 V/ 50 Hz	📦/net 60	📦/br 100		
GN 3x 1/1	°C +40/+90	⚡ 1800 W	🔌 230 V/ 50 Hz	📦/net 60	📦/br 100				

Kalte Theken

	Artikel	Code	Euro
	Kalte Theke <ul style="list-style-type: none"> · Temperatur: +3°C/+8°C · digitales Thermostat mit LED Display · Umluftkühlung · automatische Abtaung · Chrom-Roste · Edelstahl Korpus · Glas-Schiebetüren hinten · LED Beleuchtung 		



Abmessungen	Ausstellflächen	Leistung	Volumen	Gewicht	Verpackung		
695 x 570 x 670 mm	1x 642 x 372 mm 1x 642 x 408 mm	160 W	115 Liter	70 kg/75 kg	740 x 810 x 650 mm	HTR120.01	799,00
873 x 570 x 670 mm	1x 820 x 372 mm 1x 820 x 408 mm	160 W	146 Liter	80 kg/85 kg	740 x 990 x 650 mm	HTR160.01	889,00

	Eismaschine 2 Liter, silber <div style="float: right; background-color: red; color: white; padding: 5px; font-weight: bold; font-size: 1.2em;">NEU</div> <ul style="list-style-type: none"> · 284 x 424 x 262 mm · Temperatur: -18°C/-35°C · 180 W, 230 V, 50 Hz · vollautomatisch, Fassungsvermögen: 2 Liter · für Speiseeis, Sorbets & Frozen Joghurt · LCD Display, digitaler Timer · Produktionszyklus in 1 Stunde · erfordert kein Eis oder vorheriges Einfrieren · Verpackungsmaß: 353 x 496 x 324 mm 	EIS15	389,00	
<div style="display: flex; justify-content: space-between; align-items: center; font-size: 0.8em;"> °C -18/-35 L 2 ⚡ 180 W 🔌 230 V/ 50 Hz 📦/net 12 📦/br 13,6 </div>				

	Eismaschine 2 Liter, silber <div style="float: right; background-color: red; color: white; padding: 5px; font-weight: bold; font-size: 1.2em;">NEU</div> <ul style="list-style-type: none"> · 272 x 315 x 362 mm · Temperatur: -18°C/-35°C · 180 W, 230 V, 50 Hz · vollautomatisch, Fassungsvermögen: 2 Liter · für Speiseeis, Sorbets & Frozen Joghurt · LCD Display, digitaler Timer · Produktionszyklus in 1 Stunde · erfordert kein Eis oder vorheriges Einfrieren · Verpackungsmaß: 390 x 330 x 432 mm 	EIS20	399,00	
<div style="display: flex; justify-content: space-between; align-items: center; font-size: 0.8em;"> °C -18/-35 L 2 ⚡ 180 W 🔌 230 V/ 50 Hz 📦/net 13 📦/br 14,4 </div>				

Kalte Theken

	Artikel	Code	Euro
 <p>440er Höhe</p> <p>Edelstahl</p>	<p>Kalte Theke</p> <p>2x GN 1/1, Edelstahl</p> <ul style="list-style-type: none"> · 940 x 655 x 440 mm · Temperatur: +2°C/+8°C · statische Kühlung, automatische Abtauung · 200 W, 230 V, 50 Hz · Verbrauch: 1,9 kWh/24h · Verdunstung, mit Beleuchtung · Anti-Beschlag-System für die Frontscheibe · Gebogene Panorama-Frontkippscheibe, gehärtet · Höhenverstellbare Schraubfüße · Digitale Temperaturanzeige, inkl. GN-Behälter · Verpackungsmaß: 1000 x 850 x 700 mm 	<p>WIKTORIA 1.0</p>	<p>1.559,00</p>
 <p>440er Höhe</p> <p>Edelstahl</p>	<p>Kalte Theke</p> <p>2x GN 1/1, Edelstahl</p> <ul style="list-style-type: none"> · 1320 x 655 x 440 mm · Temperatur: +2°C/+8°C · statische Kühlung, automatische Abtauung · 210 W, 230 V, 50 Hz · Verbrauch: 2,1 kWh/24h · Verdunstung, mit Beleuchtung · Anti-Beschlag-System für die Frontscheibe · Gebogene Panorama-Frontkippscheibe, gehärtet · Höhenverstellbare Schraubfüße · Digitale Temperaturanzeige, inkl. GN-Behälter · Verpackungsmaß: 1500 x 850 x 700 mm 	<p>WIKTORIA 1.3</p>	<p>1.769,00</p>
 <p>Edelstahl</p>	<p>Kalte Theke</p> <p>95 Liter, gekühlt, Edelstahl</p> <ul style="list-style-type: none"> · 810 x 770 x 610 (+/-10) mm · 2x GN 1/1 · Temperatur: +2°C/+8°C · statische Kühlung, automatische Abtauung · 130 W, 230 V, 50 Hz · Verbrauch: 2,1 kWh/24h · Verdunstung, mit Beleuchtung · Anti-Beschlag-System für die Frontscheibe · Gebogene Panorama-Frontkippscheibe, gehärtet · inkl. GN-Behälter · Verpackungsmaß: 1000 x 950 x 800 mm 	<p>WIKTORIA 2/1.0</p>	<p>1.659,00</p>
 <p>Edelstahl</p>	<p>Kalte Theke</p> <p>155 Liter, gekühlt, Edelstahl</p> <ul style="list-style-type: none"> · 1320 x 770 x 610 (+/- 10) mm · 3x GN 1/1 · Temperatur: +2°C/+8°C · statische Kühlung, automatische Abtauung · 210 W, 230V, 50Hz · Verbrauch: 3kW · Verdunstung, mit Beleuchtung · Anti-Beschlag-System für Frontscheibe · zusätzliche Ablage gegen Aufpreis · inkl. GN-Behälter · Verpackungsmaß: 1500 x 950 x 800 mm 	<p>WIKTORIA 2/1.3</p>	<p>1.899,00</p>

GASTROLINE - Kuchenvitrinen/Neutraltheken

GASTROLINE CUBE (W)

- Außenverkleidung aus schwarzbeschichtetem Blech, Innenmaßgestell sibern- oder goldbeschichtet, untere Ablage aus schwarzem Melamin
- Hintere Schiebetür mit Isolierglasung, gerade Frontverglasung, Antibeschlagbelüftung, automatisch Abtauung, automatische Tauwasserverdunstung



mit LED-Beleuchtung

Artikel

Kuchenvitrine GASTROLINE CUBE (W)

- 610 x 1270 x 835 mm
- Temperatur: 5°C/15°C
- Kühlaggregat Innenmaß
- Dynamische Kühlung
- Innenmaßbeleuchtung mit LED-Leuchtstoffröhren
- Glasauslagen höhen- und neigungsverstellbar
- Elektronische Temperaturregelung mit Digital-Display

610 x 1270 (+/-10) x 835 mm

· 4,6 kWh/24h

910 x 1270 (+/-10) x 835 mm

· 7,9 kWh/24h

1310 x 1270 (+/-10) x 835 mm

· 10,4 kWh/24h



Code Euro

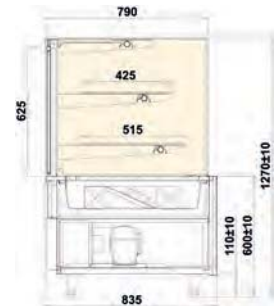

GC103 3.529,00

GC102 3.949,00

GC101 4.259,00



Lieferung ohne Tabletrutsche!

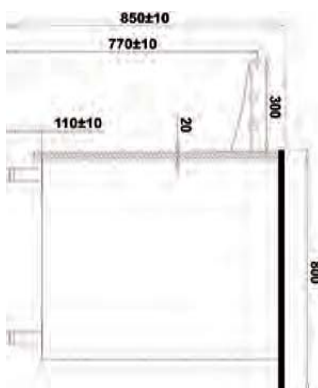

Neutraltheke LADA GASTROLINE

- Außenverkleidung aus schwarzem Melamin
- geteilter Frontteil mit Spiegelement
- Ausfahrbare Schublade
- Granitarbeitsplatte grau (30 mm)
- Höhenverstellbare FüÙe

500 x 850 (+/-10) x 800 mm

600 x 850 (+/-10) x 800 mm

700 x 850 (+/-10) x 800 mm

800 x 850 (+/-10) x 800 mm

900 x 850 (+/-10) x 800 mm

1000 x 850 (+/-10) x 800 mm

1100 x 850 (+/-10) x 800 mm

1200 x 850 (+/-10) x 800 mm

1300 x 850 (+/-10) x 800 mm

1400 x 850 (+/-10) x 800 mm

1500 x 850 (+/-10) x 800 mm

Optional:
Frontablage pro Meter

Hinweis:
Beim Kauf einer Theke mit bereits monierter Tabletrutsche: 199€ pro laufender Meter!

LS/GL50 489,00 €

LS/GL60 579,00 €

LS/GL70 699,00 €

LS/GL80 779,00 €

LS/GL90 859,00 €

LS/GL100 969,00 €

LS/GL110 1.059,00 €

LS/GL120 1.159,00 €

LS/GL130 1.259,00 €

LS/GL140 1.349,00 €

LS/GL150 1.449,00 €

GL1117 209,-

GASTROLINE - Heiße Theken

GASTROLINE/GASTROLINE OPEN

- Außenverkleidung aus schwarzbeschichtetem Blech, Geteilter Frontteil aus schwarzem Melamin mit Spiegelement o. rostfreiem geschliffenem Blechelement
- Gestell mit Führungsleisten geeignet für GN-Behälter, Unterbau aus weißbeschichtetem Blech und höhenverstellbarer Ablage, hintere Drehflügeltür
- Granitarbeitsplatte grau (Stärke: 30 mm), Automatische Abtaung und Tauwasserverdunstung

Granitstärke: 30 mm

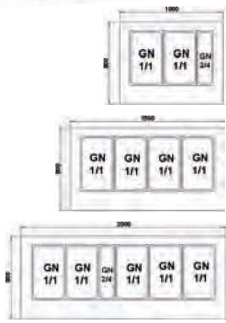

Lieferung ohne Tabletrutsche!

Granitstärke: 30 mm

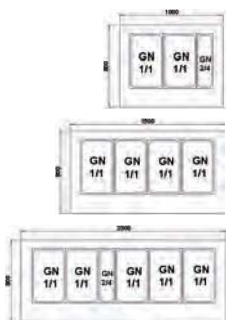

mit LED-Beleuchtung

Artikel

Heiße Theke GASTROLINE

- Bainmarie
- Temperatur: 30°C/90°C
- Glasaufsatz mit gerader Frontverglasung
- Beleuchtung mit LED-Leuchtstoffröhre (weiß)
- Höhenverstellbare Füße
- Elektronische Temperaturregelung mit Digital-Display
- Optional: Frontablage für Kunden (300 mm tief)



Hinweis:

Beim Kauf einer Theke mit bereits monierter Tabletrutsche: 199€ pro laufender Meter!

1000 x 1250 (+/-10) x 800 mm

2x 1/1 GN, 1x 2/4 GN

1500 x 1250 (+/-10) x 800 mm

4x 1/1 GN

2000 x 1250 (+/-10) x 800 mm

5x 1/1 GN, 1x 2/4 GN

Optional:

Frontablage pro Meter



+30/+90

Code

Euro

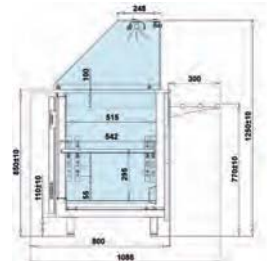

GL103

2.569,00

GL104

3.269,00

GL105

4.169,00

GL1117

209,00

Heiße Theke GASTROLINE OPEN

- Bainmarie
- Temperatur: 30°C/90°C
- Glasaufsatz mit gerader Frontverglasung
- Beleuchtung mit LED-Leuchtstoffröhre (weiß)
- Höhenverstellbare Füße
- Elektronische Temperaturregelung mit Digital-Display
- Optional: Frontablage für Kunden (300 mm tief)



Hinweis:

Beim Kauf einer Theke mit bereits monierter Tabletrutsche: 199€ pro laufender Meter!

1000 x 1250 (+/-10) x 800 mm

2x 1/1 GN, 1x 2/4 GN

1500 x 1250 (+/-10) x 800 mm

4x 1/1 GN

2000 x 1250 (+/-10) x 800 mm

5x 1/1 GN, 1x 2/4 GN

Optional:

Frontablage pro Meter



+30/+90

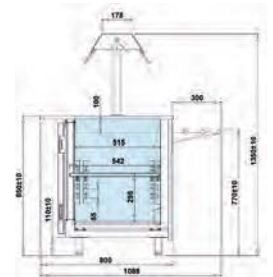

GL103/OP

2.569,00

GL104/OP

3.189,00

GL105/OP

4.139,00

GL1117

209,00

GASTROLINE - Salattheken

GASTROLINE/GASTROLINE OPEN

- Außenverkleidung aus schwarzbeschichtetem Blech, Geteilter Frontteil aus schwarzem Melamin mit Spiegelement o. rostfreiem geschliffenem Blechelement
- Gestell mit Führungsleisten geeignet für GN-Behälter, Unterbau aus weißbeschichtetem Blech und höhenverstellbarer Ablage, hintere Drehflügeltür
- Granitarbeitsplatte grau (Stärke: 30mm), Automatische Abtauung und Tauwasserverdunstung

	Artikel	Code	Euro
<p>Granitstärke: 30 mm</p>  <p>Lieferung ohne Tabletrutsche! mit LED-Beleuchtung</p> <p>Hinweis: Beim Kauf einer Theke mit bereits monierter Tabletrutsche: 199€ pro laufender Meter!</p>	<p>Salattheke GASTROLINE</p> <ul style="list-style-type: none"> · Kühlaggregat Innenmaß · Dynamische Kühlung · Temperatur: 2°C/8°C · Glasaufsatz mit gerader Frontverglasung · Beleuchtung mit LED-Leuchtstoffröhre (weiß) · Höhenverstellbare Füße · Elektronische Temperaturregelung mit Digital-Display · <u>Optional:</u> Frontablage für Kunden (300 mm tief) 		
	<p>1000 x 1250 (+/-10) x 800 mm 2x 1/1 GN, 1x 2/4 GN</p>	GL107	2.599,00
	<p>1500 x 1250 (+/-10) x 800 mm 4x 1/1 GN</p>	GL100	2.979,00
	<p>2000 x 1250 (+/-10) x 800 mm 5x 1/1 GN, 1x 2/4 GN</p>	GL101	3.549,00
	<p>2500 x 1250 (+/-10) x 800 mm 7x 1/1 GN</p>	GL102	4.199,00
	<p>Optional: Frontablage pro Meter</p>	GL1117	209,00
	<p>°C +2/+8</p>		
<p>Granitstärke: 30 mm</p>  <p>mit LED-Beleuchtung</p> <p>Hinweis: Beim Kauf einer Theke mit bereits monierter Tabletrutsche: 199€ pro laufender Meter!</p>	<p>Salattheke GASTROLINE OPEN</p> <ul style="list-style-type: none"> · Kühlaggregat Innenmaß · Dynamische Kühlung · Temperatur: 2°C/8°C · Aufsatz „OPEN“ aus rostfreiem Blech mit Glasplatte · Beleuchtung mit LED-Leuchtstoffröhre (weiß) · Höhenverstellbare Füße · Elektronische Temperaturregelung mit Digital-Display 		
	<p>1000 x 1250 (+/-10) x 800 mm 2x 1/1 GN, 1x 2/4 GN</p>	GL107/OP	2.739,00
	<p>1500 x 1250 (+/-10) x 800 mm 4x 1/1 GN</p>	GL100/OP	3.239,00
	<p>2000 x 1250 (+/-10) x 800 mm 5x 1/1 GN, 1x 2/4 GN</p>	GL101/OP	3.929,00
	<p>2500 x 1250 (+/-10) x 800 mm 7x 1/1 GN</p>	GL102/OP	4.659,00
	<p>Optional: Frontablage pro Meter</p>	GL1117	209,00
	<p>°C +2/+8</p>		

Wärmebuffet

















3x GN 1/1



4x GN 1/1



6x GN 1/1

	Artikel	Code	Euro
	<p>Gastro Buffet HOT ohne Behälter</p> <ul style="list-style-type: none"> · 1190 x 900 x 870 mm · 3x GN 1/1 · 2013 W, 230 V, 50 Hz · Edelstahl mit Holzpanelle · Granit- Arbeitsplatte · auf 4 Rollen · Hustenschutz nicht verstellbar · inkl. Beleuchtung · Verpackungsmaß: 1250 x 980 x 1320 mm 	 <p>SHBM3</p>	<p>1.969,00</p>
	<p>GN   </p> <p>3x 1/1 2013 W 108,5 143</p>		
	<p>Gastro Buffet HOT ohne Behälter</p> <ul style="list-style-type: none"> · 1520 x 900 x 870/1320 mm¹ · 4x GN 1/1 · 3026 W, 230 V, 50 Hz · Edelstahl mit Holzpanelle · Granit- Arbeitsplatte · auf 4 Rollen · Hustenschutz nicht verstellbar · inkl. Beleuchtung · Verpackungsmaß: 1560 x 980 x 1320 mm 	 <p>SHBM4</p>	<p>2.339,00</p>
	<p>GN   </p> <p>4x 1/1 3026 W 127,8 172</p>		
	<p>Gastro Buffet HOT ohne Behälter</p> <ul style="list-style-type: none"> · 2180 x 900 x 870/1320 mm · 6x GN 1/1 · 4026 W, 230 V, 50 Hz · Edelstahl mit Holzpanelle · Granit- Arbeitsplatte · auf 4 Rollen · Hustenschutz nicht verstellbar · inkl. Beleuchtung · Verpackungsmaß: 2240 x 980 x 1320 mm 	 <p>SHBM6</p>	<p>2.979,00</p>
	<p>GN   </p> <p>6x 1/1 4026 W 174 246</p>		

Kältebuffet



3x GN 1/1



4x GN 1/1



6x GN 1/1

	Artikel	Code	Euro
	<p>Gastro Buffet Salatbar ohne Behälter</p> <ul style="list-style-type: none"> · 1190 x 900 x 870/1320 mm · 3x GN 1/1-150 · Temperatur: +2°C/+10°C · 230 V, 50 Hz · Edelstahl mit Holzpanelle · Granit-Arbeitsplatte · Hustenschutz nicht verstellbar · inkl. Beleuchtung · Verpackungsmaß: 1250 x 980 x 1320 mm 	<p>SBM3.01</p> <p>Kältemittel: R290</p>	<p>2.449,00</p>
	<p>GN °C kg/net kg/br</p> <p>3x 1/1 +2/+10 137 167</p>		
	<p>Gastro Buffet Salatbar ohne Behälter</p> <ul style="list-style-type: none"> · 1505 x 900 x 870/1320 mm · 4x GN 1/1 · Temperatur: +2°C/+10°C · 230 V, 50 Hz · Edelstahl mit Holzpanelle · Granit-Arbeitsplatte · Hustenschutz nicht verstellbar · inkl. Beleuchtung · Verpackungsmaß: 1560 x 980 x 1320 mm 	<p>SBM4.01</p> <p>Kältemittel: R290</p>	<p>2.629,00</p>
	<p>GN °C kg/net kg/br</p> <p>4x 1/1 +2/+10 144 190</p>		
	<p>Gastro Buffet Salatbar ohne Behälter</p> <ul style="list-style-type: none"> · 2180 x 900 x 870/1320 mm · 6x GN 1/1 · Temperatur: +2°C/+10°C · 3200 W, 230 V, 50 Hz · Edelstahl mit Holzpanelle · Granit-Arbeitsplatte · Hustenschutz nicht verstellbar · inkl. Beleuchtung · Verpackungsmaß: 2240 x 980 x 1320 mm 	<p>SBM6.01</p> <p>Kältemittel: R290</p>	<p>3.499,00</p>
	<p>GN °C W kg/net kg/br</p> <p>4x 1/1 +2/+10 3200 W 191 259</p>		

Wärmebuffet









GN 3/1



GN 4/1



GN 6/1

	Artikel	Code	Euro										
	<p>Gastro Buffet HOT ohne Behälter</p> <ul style="list-style-type: none"> · 1200 x 900 x 850/1350 mm · GN 3/1 · Temperatur: +30°C/+90°C · 2x 1,2 kW, 230 V, 50 Hz · Granit-Arbeitsplatte · inkl. Beleuchtung · Verpackungsmaß: 1260 x 980 x 1140 mm 	 <p>SB-H GN120</p>	<p>2.059,00</p>										
	<table border="1"> <tr> <td>GN</td> <td>°C</td> <td>⚡</td> <td>kg/net</td> <td>kg/br</td> </tr> <tr> <td>3/1</td> <td>+30/+90</td> <td>2400 W</td> <td>100</td> <td>130</td> </tr> </table>	GN	°C	⚡	kg/net	kg/br	3/1	+30/+90	2400 W	100	130		
GN	°C	⚡	kg/net	kg/br									
3/1	+30/+90	2400 W	100	130									
	<p>Gastro Buffet HOT ohne Behälter</p> <ul style="list-style-type: none"> · 1550 x 900 x 850/1350 mm · GN 4/1 · Temperatur: +30°C/+90°C · 2x 1,25 kW, 230 V, 50 Hz · Granit-Arbeitsplatte · inkl. Beleuchtung · Verpackungsmaß: 1610 x 980 x 1140 mm 	 <p>SB-H GN155</p>	<p>2.179,00</p>										
	<table border="1"> <tr> <td>GN</td> <td>°C</td> <td>⚡</td> <td>kg/net</td> <td>kg/br</td> </tr> <tr> <td>4/1</td> <td>+30/+90</td> <td>2500 W</td> <td>120</td> <td>155</td> </tr> </table>	GN	°C	⚡	kg/net	kg/br	4/1	+30/+90	2500 W	120	155		
GN	°C	⚡	kg/net	kg/br									
4/1	+30/+90	2500 W	120	155									
	<p>Gastro Buffet HOT ohne Behälter</p> <ul style="list-style-type: none"> · 2200 x 900 x 850/1350 mm · GN 6/1 · Temperatur: 0°C/+10°C · 3x 1,25 kW, 230 V, 50 Hz · Granit-Arbeitsplatte · mit Beleuchtung · Verpackungsmaß: 2260 x 980 x 1140 mm 	 <p>SB-H GN220</p>	<p>2.799,00</p>										
	<table border="1"> <tr> <td>GN</td> <td>°C</td> <td>⚡</td> <td>kg/net</td> <td>kg/br</td> </tr> <tr> <td>6/1</td> <td>+30/+90</td> <td>3750 W</td> <td>175</td> <td>215</td> </tr> </table>	GN	°C	⚡	kg/net	kg/br	6/1	+30/+90	3750 W	175	215		
GN	°C	⚡	kg/net	kg/br									
6/1	+30/+90	3750 W	175	215									

Kältebuffet









GN 3/1











GN 4/1



GN 6/1

	Artikel	Code	Euro
	<p>Gastro Buffet Salatbar ohne Behälter</p> <ul style="list-style-type: none"> · 1200 x 900 x 850/1350 mm · GN 3/1 · Temperatur: 0°C/+10°C · 389 W, 230 V, 50 Hz · Granit-Arbeitsplatte · inkl. Beleuchtung · Verpackungsmaß: 1260 x 980 x 1140 mm 	<p>SB-C GN120.01</p> 	<p>2.179,00</p>
	<p>GN 3/1 °C 0/+10 ⚡ 389 W 230 V / 50 Hz kg/net 135 kg/br 165</p>		
	<p>Gastro Buffet Salatbar ohne Behälter</p> <ul style="list-style-type: none"> · 1550 x 900 x 850/1350 mm · GN 4/1 · Temperatur: 0°C/+10°C · 507 W, 220 V, 50 Hz · Granit-Arbeitsplatte · inkl. Beleuchtung · Verpackungsmaß: 1610 x 980 x 1140 mm 	<p>SB-C GN155.01</p> 	<p>2.299,00</p>
	<p>GN 4/1 °C 0/+10 ⚡ 507 W 230 V / 50 Hz kg/net 145 kg/br 180</p>		
	<p>Gastro Buffet Salatbar GN 6/1 - ohne Behälter</p> <ul style="list-style-type: none"> · 2200 x 900 x 850/1350 mm · GN 6/1 · Temperatur: 0°C/+10°C · 790 W, 220 V, 50 Hz · Granit-Arbeitsplatte · inkl. Beleuchtung · Verpackungsmaß: 2250 x 980 x 1140 mm 	<p>SB-C GN220.01</p> 	<p>2.969,00</p>
	<p>GN 6/1 °C 0/+10 ⚡ 790 W 230 V / 50 Hz kg/net 195 kg/br 235</p>		

Gastronormbehälter

	Artikel	Code	Euro
	1/1 GN 530 x 325 x 20 mm 530 x 325 x 40 mm 530 x 325 x 65 mm 530 x 325 x 100 mm 530 x 325 x 150 mm 530 x 325 x 200 mm	GN1/1-20 GN1/1-40 GN1/1-65 GN1/1-100 GN1/1-150 GN1/1-200	10,00 13,00 15,00 19,00 26,00 35,00
	1/2 GN 325 x 265 x 20 mm 325 x 265 x 40 mm 325 x 265 x 65 mm 325 x 265 x 100 mm 325 x 265 x 150 mm 325 x 265 x 200 mm	GN1/2-20 GN1/2-40 GN1/2-65 GN1/2-100 GN1/2-150 GN1/2-200	7,00 8,50 10,00 12,00 17,00 22,00
	2/4 GN 530 x 165 x 20 mm 530 x 165 x 40 mm 530 x 165 x 65 mm 530 x 165 x 100 mm 530 x 165 x 150 mm	GN2/4-20 GN2/4-40 GN2/4-65 GN2/4-100 GN2/4-150	12,00 14,00 16,00 21,00 29,00
	1/4 GN 265 x 165 x 20 mm 265 x 165 x 40 mm 265 x 165 x 65 mm 265 x 165 x 100 mm 265 x 165 x 150 mm 265 x 165 x 200 mm	GN1/4-20 GN1/4-40 GN1/4-65 GN1/4-100 GN1/4-150 GN1/4-200	4,00 6,00 8,00 9,00 13,50 24,00
	2/3 GN 354 x 325 x 20 mm 354 x 325 x 40 mm 354 x 325 x 65 mm 354 x 325 x 100 mm 354 x 325 x 150 mm 354 x 325 x 200 mm	GN2/3-20 GN2/3-40 GN2/3-65 GN2/3-100 GN2/3-150 GN2/3-200	8,50 10,00 11,00 14,00 21,00 26,00
	1/3 GN 325 x 176 x 20 mm 325 x 176 x 40 mm 325 x 176 x 65 mm 325 x 176 x 100 mm 325 x 176 x 150 mm 325 x 176 x 200 mm	GN1/3-20 GN1/3-40 GN1/3-65 GN1/3-100 GN1/3-150 GN1/3-200	5,50 6,50 7,50 9,50 15,00 29,00
	1/6 GN 176 x 162 x 65 mm 176 x 162 x 100 mm 176 x 162 x 150 mm 176 x 162 x 200 mm	GN1/6-65 GN1/6-100 GN1/6-150 GN1/6-200	5,00 7,00 13,00 22,00
	1/9 GN 176 x 108 x 65 mm 176 x 108 x 100 mm 176 x 108 x 150 mm	GN1/9-65 GN1/9-100 GN1/9-150	4,40 6,00 14,00



7

Kühltheken

Serie Sado	114 - 115
Serie Hill	116
Serie Geres	116
Serie Cordoba	117
Serie MAISTER Plus	118
Serie MAISTER 80	119
Serie Rota	120
Serie Melody	120
Serie Regua	121
Serie Cake	122 - 123
Serie Tejo	124

Kühlvitrienen - Unterbau Aggregat

	Artikel	Code	Euro
 <p>← 790 mm → ← 1000 mm →</p>	Kühlvitrine Sado eckige Scheiben <ul style="list-style-type: none"> · 1000 x 790 x 1233 mm · Temperatur: +2°C/+6°C · stille Kühlung · Auslagefläche 570 x 900 mm · Arbeitsplatte aus Marmor · Kippbare Frontscheibe · Instrumentbrett mit Thermostat · Timer, 10 Ampere-Steckdose · Verpackungsmaß: 1100 x 1000 x 1010 mm 	PA.SAT.10GP	1.589,00
 <p>← 790 mm → ← 1500 mm →</p>	Kühlvitrine Sado eckige Scheiben <ul style="list-style-type: none"> · 1500 x 790 x 1233 mm · Temperatur: +2°C/+6°C · stille Kühlung · Auslagefläche 570 x 1400 mm · Arbeitsplatte aus Marmor · Kippbare Frontscheibe · Instrumentenbrett mit Thermostat · Timer, 10-Ampere-Steckdose · Verpackungsmaß: 1600 x 1000 x 1010 mm 	PA.SAT.15GP	1.849,00
 <p>← 790 mm → ← 1000 mm →</p>	Kühlvitrine Sado runde Scheiben <ul style="list-style-type: none"> · 1000 x 790 x 1233 mm · Temperatur: +2°C/+6°C · stille Kühlung · Auslagefläche 570 x 900 mm · Arbeitsplatte aus Marmor · Kippbare Frontscheibe · Instrumentenbrett mit Thermostat · Timer, 10-Ampere-Steckdose · Verpackungsmaß: 1100 x 1000 x 1010 mm 	PA.SAT.10GC	1.829,00
 <p>← 790 mm → ← 1500 mm →</p>	Kühlvitrine Sado runde Scheiben <ul style="list-style-type: none"> · 1500 x 790 x 1233 mm · Temperatur: +2°C/+6°C · stille Kühlung · Auslagefläche 570 x 1400 mm · gebogene Scheibe · Arbeitsplatte aus Marmor · Kippbare Frontscheibe · Instrumentenbrett mit Thermostat · Timer, 10-Ampere-Steckdose · Verpackungsmaß: 1600 x 1000 x 1010 mm 	PA.SAT.15GC	2.089,00

°C +2/+6 kg/net 116 kg/br 160

°C +2/+6 kg/net 154 kg/br 210

°C +2/+6 kg/net 120 kg/br 176

°C +2/+6 kg/net 170 kg/br 248,2

Kühlvittrinen - inkl. Rollgestell Standard

	Artikel	Code	Euro
 <p>← 990 mm → ← 1000 mm →</p>	<p>Kühlvitrine Sado eckige Scheiben</p> <ul style="list-style-type: none"> · 1000 x 990 x 1233 mm · Temperatur: +2°C/+6°C · stille Kühlung · 230 V, 50 Hz · Arbeitsplatte aus Marmor · Kippbare Frontscheibe · Instrumentbrett mit Thermostat · Timer, 10 Ampere-Steckdose 	PA.SAD.10GP	1.559,00
<p>°C +2/+6 230 V / 50 Hz kg/net 120 kg/br 176</p>			
 <p>← 990 mm → ← 1500 mm →</p>	<p>Kühlvitrine Sado eckige Scheiben</p> <ul style="list-style-type: none"> · 1500 x 990 x 1233 mm · Temperatur: +2°C/+6°C · stille Kühlung · 230 V, 50 Hz · gerade Scheibe · Arbeitsplatte aus Marmor · Kippbare Frontscheibe · Instrumentbrett mit Thermostat · Timer, 10 Ampere-Steckdose 	PA.SAD.15GP	1.829,00
<p>°C +2/+6 230 V / 50 Hz kg/net 170 kg/br 248,2</p>			
 <p>← 990 mm → ← 1000 mm →</p>	<p>Kühlvitrine Sado runde Scheiben</p> <ul style="list-style-type: none"> · 1000 x 990 x 1233 mm · Temperatur: +2°C/+6°C · stille Kühlung · 230 V, 50 Hz · gebogene Scheibe · Arbeitsplatte aus Marmor · Kippbare Frontscheibe · Instrumentbrett mit Thermostat · Timer, 10 Ampere-Steckdose 	PA.SAD.10.GC	1.799,00
<p>°C +2/+6 230 V / 50 Hz kg/net 120 kg/br 176</p>			
 <p>← 990 mm → ← 1500 mm →</p>	<p>Kühlvitrine Sado runde Scheiben</p> <ul style="list-style-type: none"> · 1500 x 990 x 1233 mm · Temperatur: +2°C/+6°C · stille Kühlung · 230 V, 50 Hz · gebogene Scheibe · Arbeitsplatte aus Marmor · Kippbare Frontscheibe · Instrumentbrett mit Thermostat · Timer, 10 Ampere-Steckdose 	PA.SAD.15.GC	2.089,00
<p>°C +2/+6 230 V / 50 Hz kg/net 170 kg/br 248,2</p>			

Kühltheken



statische Kühlung

Maße	Power	Code	Euro
1000 x 790 x 1220 mm	0,245 kW	HILL 100.01	1.929,00
1500 x 790 x 1220 mm	0,245 kW	HILL 150.01	2.129,00
2000 x 790 x 1220 mm	0,323 kW	HILL 200.01	2.399,00
2500 x 790 x 1220 mm	0,491 kW	HILL 250.01	2.869,00
3000 x 790 x 1220 mm	0,762 kW	HILL 300.01	3.319,00

Hill

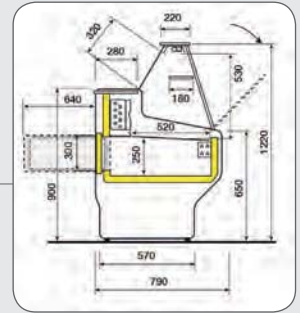

Kühltheke

- Temperatur: +4°C/+6°C
- 230 V, 50 Hz
- Tiefe 790 mm
- Hergestellt aus weißem, kunststoffüberzogenem Stahlblech
- Auslagefläche aus Edelstahl AISI 304
- Polyurethan Isolierung
- Seiten aus warmverformtem ABS
- Arbeitsfläche aus Granit
- Gekühltes Reservfach mit unabhängigem Verdampfer
- gerades Frontglas
- mit Glaszwischenablage
- mit Beleuchtung

Standardfarbe

Blau



statische Kühlung

Maße	Code	Euro
1000 x 970 x 1270 mm	GERES1000	1.979,00
1500 x 970 x 1270 mm	GERES1500	2.459,00
2000 x 970 x 1270 mm	GERES2000	2.959,00
2500 x 970 x 1270 mm	GERES2500	3.499,00

Geres

Kühltheke

Modell Serie Geres

- Temperatur: +2°C/+6°C
- 230 V, 50 Hz
- mit gekühltem Unterbau (**stille Kühlung**)
- mit Zeitschaltuhr für automatische Abtauung
- Glaszwischenablage mit Beleuchtung

Standardfarbe

Grau

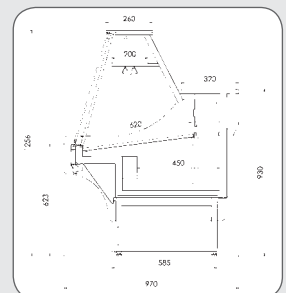

Kühltheken



Abbildung ähnlich

Cordoba

Kühltheke

- 230 V, 50 Hz
- Tiefe 895 mm
- Hergestellt aus weißem, kunststoffüberzogenem Stahlblech
- Auslagefläche aus Edelstahl AISI 304
- Polyurethan Isolierung
- Seiten aus warmverformtem ABS
- Arbeitsfläche aus Granit
- Gekühltes Reservefach mit unabhängigem Verdampfer
- gebogenes Frontglas mit Öffnung von oben
- mit Beleuchtung

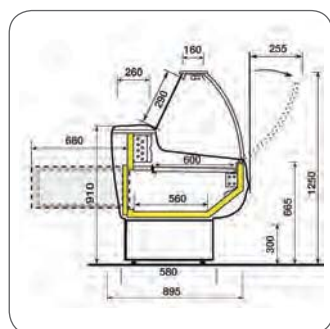

+4°C/+6°C

statische Kühlung

Maße	Power	Code	Euro
1040 x 895 x 1250 mm	0,25 kW	Cordoba 100.01	2.199,00
1500 x 895 x 1230 mm	0,25 kW	Cordoba 150.01	2.459,00
2000 x 895 x 1230 mm	0,328 kW	Cordoba 200.01	2.889,00
2500 x 895 x 1230 mm	0,491 kW	Cordoba 250.01	3.219,00
3000 x 895 x 1230 mm	0,759 kW	Cordoba 300.01	3.859,00

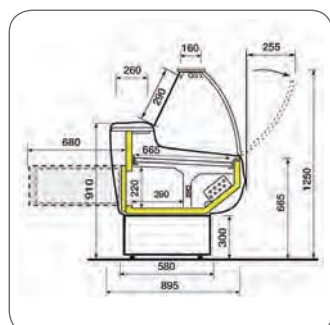

0°C/+2°C

Umluftkühlung

Maße	Power	Code	Euro
1040 x 895 x 1250 mm	0,367 kW	Cordoba 100U.01	2.719,00
1500 x 895 x 1250 mm	0,491 kW	Cordoba 150U.01	3.279,00
2000 x 895 x 1250 mm	0,759 kW	Cordoba 200U.01	3.519,00
2500 x 895 x 1250 mm	0,784 kW	Cordoba 250U.01	4.039,00
3000 x 895 x 1250 mm	0,977 kW	Cordoba 300U.01	4.799,00



Kühltheke - Maister Plus & Maister Lux

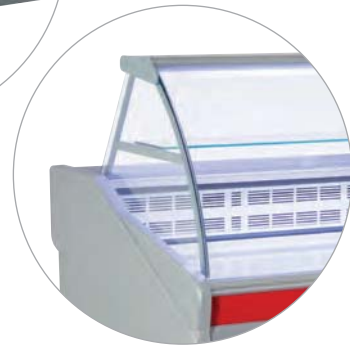

Kühltheke: Standard-Ausstattung

- isolierte und tiefgezogene Seitenwände (50 mm dick) mit Seiten aus Hartglas
- elektronische Schalttafel, automatische Abtaung
- Kühllagerung mit Türen, Neon-Beleuchtung
- Arbeitsplatte aus kratzfest lackiertem Holz
- Display-Oberfläche aus weiß lackiertem Stahlblech (ungiftig, geeignet für Lebensmittel)

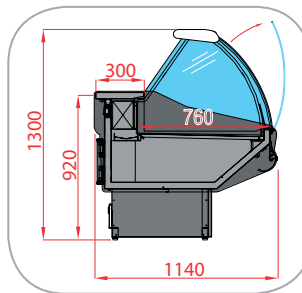

Standardfarbe

Rot
RAL3020



oben mit Stahlblech-Ablage:

Kühltheke

- mit gebogenem Hartglas und lackierter Stahlblech-Ablage
- **Standardfarbe: Rot (RAL 3020)**
- Temperatur: +3°C/+5°C



Maße	Power	L	Code	Euro
1540 x 1300 x 1140 mm	581 W, 230 V, 50 Hz	274	Maister Plus 150	2.879,00
2020 x 1300 x 1140 mm	660 W, 230 V, 50 Hz	365	Maister Plus 200	3.199,00
2500 x 1300 x 1140 mm	785 W, 230 V, 50 Hz	456	Maister Plus 250	3.659,00
2500 x 1140 x 1255 mm	785 W, 230 V, 50 Hz	456	Maister Lux 250	4.459,00

Besonderheit

Andere Farben erhältlich!
Jederzeit austauschbar!





Kühltheke - Maister 80



Kühltheke: Standard-Ausstattung

- isolierte und tiefgezogene Seitenwände (50 mm dick) mit Seiten aus Hartglas
- elektronische Schalttafel, automatische Abtaung
- Kühllagerung mit Türen, Neon-Beleuchtung
- Arbeitsplatte aus kratzfest lackiertem Holz
- Display-Oberfläche aus weiß lackiertem Stahlblech (ungiftig, geeignet für Lebensmittel)

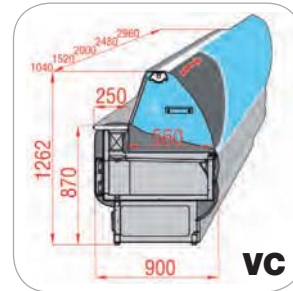

mit gebogenem Hartglas (VC)



mit gebogenem Hartglas und lackierter Stahlblech-Ablage (VCC)



Kühltheke

- mit gebogenem Hartglas
- **Standardfarbe: Blau (RAL 5013)**
- Temperatur: +3°C/+5°C



VC

voll Glasscheibe:

Besonderheit

**Andere Farben erhältlich!
Jederzeit austauschbar!**



Maße	Power	L	Code	Euro
1040 x 1262 x 900 mm	390 W, 230 V, 50 Hz	120	Maister 100	1.719,00
1520 x 1262 x 900 mm	390 W, 230 V, 50 Hz	249	Maister 150	1.849,00
2000 x 1262 x 900 mm	540 W, 230 V, 50 Hz	332	Maister 200	2.139,00
2480 x 1262 x 900 mm	730 W, 230 V, 50 Hz	415	Maister 250	2.589,00
2960 x 1262 x 900 mm	850 W, 230 V, 50 Hz	498	Maister 300	2.959,00

Kühltheke

- mit gebogenem Hartglas und lackierter Stahlblech-Ablage
- **Standardfarbe: Blau (RAL 5013)**
- Temperatur: +3°C/+5°C



VCC

oben mit Stahlblech-Ablage:



Maße	Power	L	Code	Euro
1040 x 1292 x 900 mm	390 W, 230 V, 50 Hz	120	Maister 100 VCC	1.719,00
1520 x 1292 x 900 mm	390 W, 230 V, 50 Hz	249	Maister 150 VCC	1.849,00
2000 x 1292 x 900 mm	540 W, 230 V, 50 Hz	332	Maister 200 VCC	2.139,00
2480 x 1292 x 900 mm	730 W, 230 V, 50 Hz	415	Maister 250 VCC	2.589,00
2960 x 1292 x 900 mm	850 W, 230 V, 50 Hz	498	Maister 300 VCC	2.959,00

Kühltheken



statische Kühlung

Rota

Kühltheke

- Temperatur: +2°C/+8°C
- Verdunstung, mit Beleuchtung
- automatische Abtauung
- Unterbaukühlung
- mit gebogener Scheibe

Maße	Ausstellfläche	Code	Euro
1310 x 810 x 1220 mm	490 x 1220 mm	ROTA2/1.3G	1.839,00
1510 x 810 x 1220 mm	490 x 1420 mm	ROTA2/1.5G	1.949,00



Fahrbare Fischtheke „Regua“

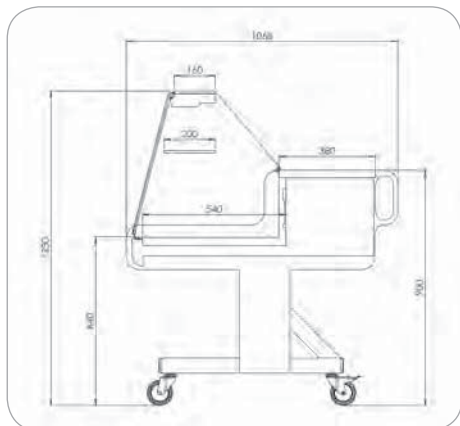

Regua - Fisch

	Artikel	Code	Euro						
	Fahrbare Fischtheke <ul style="list-style-type: none"> · 1074 x 1114 x 1105 mm · Ausstellungsfläche: 0,686 m² · Temperatur: -1°C/+3°C · elektronische Bedienung · digitaler Temperaturanzeige · innen aus Edelstahl · mit Beleuchtung · Verpackungsmaß: 1080 x 1120 x 1111 mm 	PA.RE2.10GP	1.779,00						
	<table border="1"> <tr> <td>°C</td> <td>kg/net</td> <td>kg/br</td> </tr> <tr> <td>-1/+3</td> <td>102</td> <td>140</td> </tr> </table>	°C	kg/net	kg/br	-1/+3	102	140		
°C	kg/net	kg/br							
-1/+3	102	140							
	Fahrbare Fischtheke <ul style="list-style-type: none"> · 1564 x 1114 x 1105 mm · Ausstellungsfläche: 0,954 m² · Temperatur: -1°C/+3°C · elektronische Bedienung · digitaler Temperaturanzeige · innen aus Edelstahl · mit Beleuchtung · Verpackungsmaß: 1570 x 1120 x 1111 mm 	PA.RE2.15GP	2.199,00						
	<table border="1"> <tr> <td>°C</td> <td>kg/net</td> <td>kg/br</td> </tr> <tr> <td>-1/+3</td> <td>152</td> <td>199,17</td> </tr> </table>	°C	kg/net	kg/br	-1/+3	152	199,17		
°C	kg/net	kg/br							
-1/+3	152	199,17							
	Fahrbare Fischtheke <ul style="list-style-type: none"> · 2064 x 1114 x 1105 mm · Ausstellungsfläche: 1,222 m² · Temperatur: -1°C/+3°C · elektronische Bedienung · digitaler Temperaturanzeige · innen aus Edelstahl · mit Beleuchtung · Verpackungsmaß: 2070 x 1120 x 1111 mm 	PA.RE2.20.GP	2.589,00						
	<table border="1"> <tr> <td>°C</td> <td>kg/net</td> <td>kg/br</td> </tr> <tr> <td>-1/+3</td> <td>185</td> <td>238,4</td> </tr> </table>	°C	kg/net	kg/br	-1/+3	185	238,4		
°C	kg/net	kg/br							
-1/+3	185	238,4							



Kühltheke - CAKE

Kühltheke

EVO ist die neue Kuchentheke mit **Umluftkühlung** nicht nur für Backwaren. Das gut dimensionierte Kühlsystem macht es zur idealen Lösung für vorverpackte Lebensmittel, Sandwiches und kalte Speisen.

Mit seinem eleganten und schlichten Design ist dieses Modell eine ausgezeichnete Lösung für die Anforderungen der unterschiedlichen Kunden. Dies ist möglich, dank der Flexibilität und Modularität (EVO ist erhältlich in folgenden Längen: 600-900-1200-1500-1800-2400 mm). Die **gekrümmten Panorama-Gläser** und die **3 gekühlten Einlegeböden mit Beleuchtung** ausgestattet, zusammen mit der **oberen Beleuchtung**, geben eine gute Sicht auf die gezeigten Produkte.

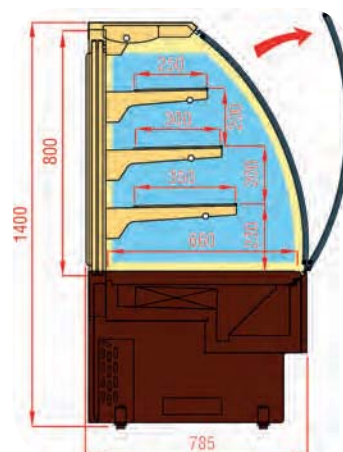
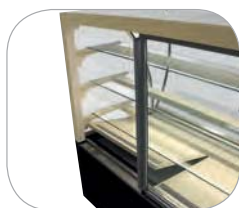

Kühltheke - CAKE



Kühltheke

Standard-Ausstattung

- isolierte und tiefgezogene Seitenwände (50 mm dick) mit Seiten aus Hartglas
- 3 Glasböden (der untere gekühlt)
- Frontscheibe aus Hartglas
- Anti-Beschlag-Frontscheibe
- Elektronische Steuerung
- Arbeitsplatte aus kratzfest lackiertem Holz
- Display-Oberfläche aus Edelstahl gekühlt
- zeitgesteuerte Abtauung und abnehmbarer Wassertank

Verfügbare Versionen

- Standard gebogene Scheiben
- gerade Scheiben
- gerade kippbare Scheiben

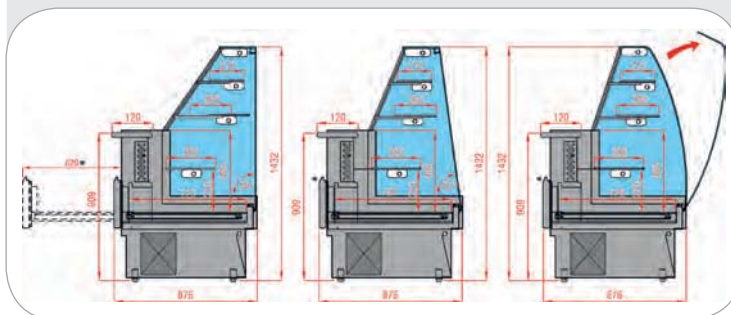



CAKE - Komplettversion



Kühltheke

- mit gebogenem Hartglas
- **Standardfarbe: schwarz** (RAL 9005)
- Temperatur: 0°C/+2°C



Maße	Power	m ²	Code	Euro
600 x 785 x 1400 mm	400 W, 230 V, 50 Hz	0,99	CAKE 60	2.329,00
900 x 785 x 1400 mm	400 W, 230 V, 50 Hz	1,41	CAKE 90	2.619,00
1200 x 785 x 1400 mm	687 W, 230 V, 50 Hz	1,88	CAKE 120	3.199,00
1500 x 785 x 1400 mm	717 W, 230 V, 50 Hz	2,34	CAKE 150	3.489,00

CAKE Self - Komplettversion



Kühltheke

- für Selbstbedienung
- **komplett aus Edelstahl**
- Temperatur: 0°C/+2°C



Maße	Power	Code	Euro
900 x 780 x 1510 mm	1114 W, 230 V, 50 Hz	CAKE Self 90	2.799,00
1500 x 780 x 1510 mm	1682 W, 230 V, 50 Hz	CAKE Self 150	3.719,00
1800 x 780 x 1510 mm	1992 W, 230 V, 50 Hz	CAKE Self 180	4.649,00

CAKE - Komplettversion

Lieferzeit beachten!

VD

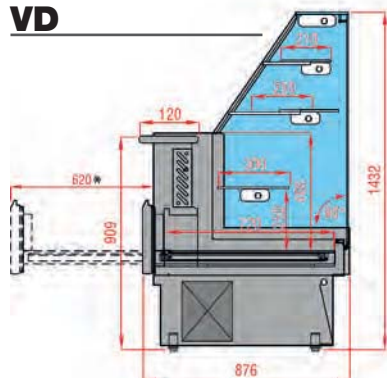

gerade Scheiben

Kühltheke

- mit geraden Scheiben
- **Standardfarbe: rot** (RAL 3020)
- Temperatur: +3°C/+5°C



Maße	Power	m ²	Code	Euro
1030 x 876 x 1432 mm	585 W, 230 V, 50 Hz	1,48	CAKE VD 100	2.559,00
1435 x 876 x 1432 mm	595 W, 230 V, 50 Hz	1,79	CAKE VD 140	2.849,00

VC

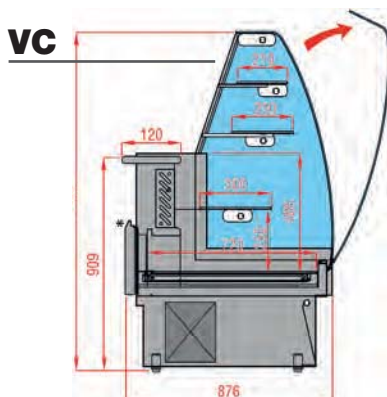

Standard gebogene Scheiben

Kühltheke

- mit gebogenem Hartglas
- **Standardfarbe: rot** (RAL 3020)
- Temperatur: +3°C/+5°C



Maße	Power	m ²	Code	Euro
1030 x 876 x 1432 mm	585 W, 230 V, 50 Hz	1,48	CAKE VC 100	2.559,00
1435 x 876 x 1432 mm	595 W, 230 V, 50 Hz	1,79	CAKE VC 140	2.849,00

Vakuummiergeräte

	Artikel	Code	Euro
	<p>Vakuummiergerät</p> <ul style="list-style-type: none"> · 330 x 480 x 320 mm als Tischgerät · Kammer Größe: 280 x 385 x 100 mm (inkl. Deckel) · 370 W, 230 V, 50 Hz · Produktionszyklus: 1-2/min · Versieglungsmaß: 260 x 8 mm · Pumpenleistung: 10 m³/h · Geeignet für: goffierte und glatte Beutel 	<p>VAC 280</p>  <p>Ersatzteile beiliegend: Öl, Teflonband, Deckeldichtung, Schweißdraht</p>	<p>1.519,00</p>
	<p>Vakuummiergerät</p> <ul style="list-style-type: none"> · 425 x 560 x 410 mm als Tischgerät · Kammer Größe: 370 x 450 x 120 mm (inkl. Deckel) · 900 W, 230 V, 50 Hz · Produktionszyklus: 1-2/min · Versieglungsmaß: 350 x 8 mm · Pumpenleistung: 20 m³/h · Geeignet für: goffierte und glatte Beutel 	<p>VAC 350 M</p>  <p>Ersatzteile beiliegend: Öl, Teflonband, Deckeldichtung, Schweißdraht</p>	<p>1.889,00</p>
	<p>Vakuummiergerät</p> <ul style="list-style-type: none"> · 475 x 555 x 460 mm als Tischgerät · Kammer Größe: 420 x 440 x 200 mm (inkl. Deckel) · 900 W, 230 V, 50 Hz · Produktionszyklus: 1-2/min · Versieglungsmaß: 400 x 8 mm · Pumpenleistung: 20 m³/h · Geeignet für: goffierte und glatte Beutel 	<p>VAC 400 G</p>  <p>Ersatzteile beiliegend: Öl, Teflonband, Deckeldichtung, Schweißdraht</p>	<p>2.019,00</p>
	<p>Vakuummiergerät</p> <ul style="list-style-type: none"> · 475 x 555 x 1050 mm als Standgerät · Kammer Größe: 440 x 420 x 200 mm (inkl. Deckel) · 900 W, 230 V, 50 Hz · Produktionszyklus: 1-2/min · Versieglungsmaß: 400 x 8 mm · Pumpenleistung: 20 m³/h · Geeignet für: goffierte und glatte Beutel 	<p>VAC 440 GL</p>  <p>Ersatzteile beiliegend: Öl, Teflonband, Deckeldichtung, Schweißdraht</p>	<p>2.259,00</p>

Kühlregale



8

Kühlregale

Wandkühlregal

126 - 127

Kühlregale Serie ITAL 60 & 80

128 - 129

Wandkühlregale

	Artikel	Code	Euro				
	Wandkühlregal 220 liter <ul style="list-style-type: none"> · 494 x 600 x 1742 mm · Temperatur: +2°C/+10°C · 1,34 kW, 230 V, 50 Hz · mit LED Beleuchtung · Umluftkühlung · Ausführung Edelstahl · Seitenteile Glas · Ausstellungsfläche 0,52 m² · 3 Regalböden Maße: 465 x 280 · Bodenablage 465 x 230 mm · automatische Abtauung · inkl. 4 Rollen mit Feststellern und Nachtrollo 	WKR.01	1.695,00				
	<table border="1"> <tr> <td>°C +2/+10</td> <td> 230 V / 50 Hz</td> <td> 131</td> <td> 150</td> </tr> </table>	°C +2/+10	 230 V / 50 Hz	 131	 150		
°C +2/+10	 230 V / 50 Hz	 131	 150				
	Wandkühlregal <ul style="list-style-type: none"> · 600 x 620 x 1432 mm · Temperatur: +2°C/+7°C · Umluftkühlung, automatische Abtauung · elektronische Bedienung · elektronische Steuerung mit digitaler Temperaturanzeige · automatische elektronische Tauwasserverdunstung · 2 verstellbare Regale · Innenbeleuchtung · Unterschiedliche Farben für die Frontblende 	Canedo60	2.130,00				
	<table border="1"> <tr> <td>°C +2/+7</td> <td> 102</td> <td> 142,98</td> </tr> </table>	°C +2/+7	 102	 142,98			
°C +2/+7	 102	 142,98					
	Wandkühlregal <ul style="list-style-type: none"> · Temperatur: +2°C/+7°C · Umluftkühlung, automatische Abtauung · elektronische Bedienung · elektronische Steuerung mit digitaler Temperaturanzeige · automatische elektronische Tauwasserverdunstung · 4 Regale, Nachtrollo und Rollen · Innenbeleuchtung 	Vouga140 Vouga200	4.140,00 5.522,00				
	<table border="1"> <tr> <td>°C +2/+7</td> </tr> </table>	°C +2/+7					
°C +2/+7							
	Wandkühlregal Edelstahl Version <ul style="list-style-type: none"> · Temperatur: +2°C/+7°C · Umluftkühlung, automatische Abtauung · elektronische Bedienung · elektronische Steuerung mit digitaler Temperaturanzeige · automatische elektronische Tauwasserverdunstung · 4 Regale und Nachtrollo · Innenbeleuchtung 	Vizela100 Vizela130 Vizela150 Vizela200	3.295,00 3.740,00 4.050,00 4.990,00				
	<table border="1"> <tr> <td>°C +2/+7</td> </tr> </table>	°C +2/+7					
°C +2/+7							

Wandkühlregale - Marao

	Artikel	Code	Euro
	<p>Kühlregal Modell Marao weiß</p> <ul style="list-style-type: none"> · mit Beleuchtung · ohne Körbe und Nachtrollo · Temperatur: +2°C/+6°C <p>Maße 1000 x 850 x 1810 mm 1200 x 850 x 1810 mm 2000 x 850 x 1810 mm</p>	<p>MARAO1000 MARAO1200 MARAO2000</p>	<p>2.130,00 2.290,00 2.440,00</p>
	<p>°C +2/+6</p> <p>kg/net 205 kg/br 241</p> <p>kg/net 206 kg/br 277</p> <p>kg/net 310 kg/br 371,5</p>		
	<p>Nachtrollo</p> <p>Maße Nachtrollo Marao 1000 mm Nachtrollo Marao 1200 mm Nachtrollo Marao 2000 mm</p>	<p>C.CT.00.010 C.CT.00.015 C.CT.00.030</p>	<p>162,00 180,00 254,00</p>
	<p>kg/net 1,32 kg/br 1,82</p> <p>kg/net 2,22 kg/br 2,72</p> <p>kg/net 2,65 kg/br 3,15</p>		
	<p>Zubehör</p> <p>Spiegel Marao 1000 · 900 x 510 mm - benötigt 1x</p> <p>Spiegel Marao 1200 · 1095 x 510 mm - benötigt 1x</p> <p>Spiegel Marao 2000 · 950 x 510 mm - benötigt 2x</p> <p>Korb Marao 1000 · 850 x 450 mm - benötigt 2x</p> <p>Korb Marao 1200 · 1050 x 450 mm - benötigt 2x</p> <p>Korb Marao 2000 · 920 x 450 mm - benötigt 4x</p>	<p>C.VD.ED.010 C.VD.ED.015 C.VD.ED.300 C.CE.00.030 C.CE.00.050 C.CE.00.040</p>	<p>63,00 84,00 129,00 109,00 129,00 129,00</p>
	<p>Wandhalterung für Körbe (4 je Korb)</p>	<p>GGG12864</p>	<p>9,90</p>



Kühlregale - ITAL 60

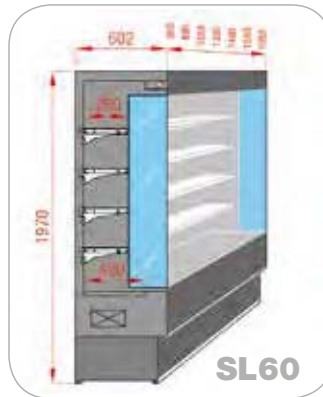

Lieferzeit

2-3 Wochen Lieferzeit

Kühlregale: Standard-Ausstattung

- isolierte und tiefgezogene Seitenwände (40 mm dick) mit Seiten aus Hartglas
- elektronische Schalttafel
- Zeitgesteuerte Abtauung
- Kühlung mit Türen
- obere innere weiße Neon-Beleuchtung
- manuelles selbstlaufendes Nachrollo
- 4 Regaleböden aus weiß lackiertem Stahlblech oder aus Edelstahl (für inox-Version), leicht höhenverstellbar, mit Preis-Schienen, ohne Beleuchtung
- Verdampfungsventil für Einbau- und Remote-Version

Kühlregale - ITAL 80

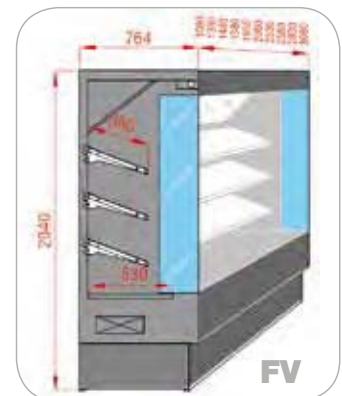
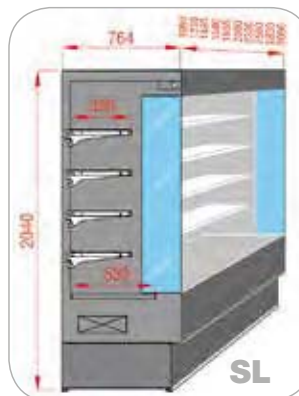
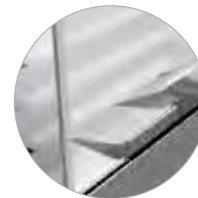

Besonderheit

Andere Farben erhältlich!
Jederzeit austauschbar!





ITAL 60 - Komplettversion



Kühlregal

- für Milchprodukte, Temperatur: +3°C/+5°C
- **Standardfarbe: blau**



Maße	Power	Code	Euro
680 x 1970 x 602 mm	1467 W/230 V/50 Hz	ITAL 60/60	2.257,00
880 x 1970 x 602 mm	1485 W/230 V/50 Hz	ITAL 60/80	2.539,00
1080 x 1970 x 602 mm	1595 W/230 V/50 Hz	ITAL 60/100	2.436,00
1330 x 1970 x 602 mm	1595 W/230 V/50 Hz	ITAL 60/125	2.642,00
1480 x 1970 x 602 mm	1595 W/230 V/50 Hz	ITAL 60/140	2.821,00
1580 x 1970 x 602 mm	1595 W/230 V/50 Hz	ITAL 60/150	3.026,00
1955 x 1970 x 602 mm	2660 W/230 V/50 Hz	ITAL 60/187	3.462,00



Kühlregal

- für Milchprodukte, Temperatur: +3°C/+5°C
- **aus Edelstahl**



Maße	Power	Code	Euro
680 x 1970 x 602 mm	1467 W/230 V/50 Hz	ITALINOX 60/60	2.026,00
880 x 1970 x 602 mm	1485 W/230 V/50 Hz	ITALINOX 60/80	2.116,00
1080 x 1970 x 602 mm	1595 W/230 V/50 Hz	ITALINOX 60/100	2.193,00
1330 x 1970 x 602 mm	1595 W/230 V/50 Hz	ITALINOX 60/125	2.822,00
1480 x 1970 x 602 mm	1595 W/230 V/50 Hz	ITALINOX 60/140	2.821,00
1580 x 1970 x 602 mm	1595 W/230 V/50 Hz	ITALINOX 60/150	3.238,00
1955 x 1970 x 602 mm	2660 W/230 V/50 Hz	ITALINOX 60/187	3.116,00

ITAL 80 - Komplettversion



Kühlregal

- für Milchprodukte, Temperatur: +3°C/+5°C
- **Standardfarbe: blau**



Maße	Power	Code	Euro
1080 x 2040 x 764 mm	1595 W/230 V/50 Hz	ITAL 80/100	2.565,00
1330 x 2040 x 764 mm	1595 W/230 V/50 Hz	ITAL 80/125	2.821,00
1480 x 2040 x 764 mm	1595 W/230 V/50 Hz	ITAL 80/140	3.077,00
1580 x 2040 x 764 mm	1595 W/230 V/50 Hz	ITAL 80/150	3.206,00
1955 x 2040 x 764 mm	2660 W/230 V/50 Hz	ITAL 80/187	3.590,00
2080 x 2040 x 764 mm	2660 W/230 V/50 Hz	ITAL 80/200	4.103,00
2330 x 2040 x 764 mm	2676 W/230 V/50 Hz	ITAL 80/225	4.188,00
2580 x 2040 x 764 mm	2684 W/230 V/50 Hz	ITAL 80/250	4.488,00
2830 x 2040 x 764 mm	2684 W/230 V/50 Hz	ITAL 80/275	5.000,00
3080 x 2040 x 764 mm	3044 W/230 V/50 Hz	ITAL 80/300	5.513,00

Thermometer

	Artikel	Code	Euro
	<p>Fleisch-Thermometer (digital)</p> <ul style="list-style-type: none"> · 150 x 22 x 15 mm · Messbereich: -50°C/+125°C, (-58°F/+302°F) · Batterie: 1x 1,5 V (LR44) · Einstechtiefe Edelstahlfühler: Ø 3,8 x 70 mm · Verpackungsmaß: 200 x 65 x 20 mm 	YSW-018	16,00
	<p>°C -50/+125</p>		
	<p>Grill-Thermometer mit Fernbedienung</p> <ul style="list-style-type: none"> · Sender: 90 x 65 x 90 mm · Empfänger: 105 x 65 x 25 mm · Edelstahlfühler: Ø 3,8 x 300 mm · Messbereich: -10°C/+250°C · Kabellänge: 870 mm · 4 wählbare Garpunkte für 5 Fleischsorten: Rind, Kalb, Schwein, Huhn, Truthahn · frei wählbare Temperatur und Timer · Signalton bei Erreichen von Garpunkt · Temperatur oder Zeitvorgabe · Verpackungsmaß: 245 x 75 x 75 mm 	YSW-020A	49,00
	<p>°C -10/+250</p>		
	<p>Fritteusen-Thermometer</p> <ul style="list-style-type: none"> · Ø 52 x 310 mm · Messbereich: +38°C/+205°C, (+100°F/+400°F) · Edelstahlfühler: Ø 3,8 x 296 mm · inkl. Befestigungsklemme 	YSW-002A	8,80
<p>spülmaschinenfest</p>	<p>°C +38/+205</p>		

Rund ums Eis











9

Rund ums Eis

Tiefkühltruhen	132 - 136
Speiseeisverkaufstruhen	133
Flaschen-Kühltruhen	137
Speiseeismaschinen	138
Eiswürfelbereiter	139
BREMA-Eiswürfelbereiter	140 - 149

Tiefkühltruhen mit Glasschiebedeckel

	Artikel	Code	Euro								
 <div style="background-color: red; color: white; padding: 5px; display: inline-block; font-weight: bold;">NEU</div>	<p>Tiefkühltruhe mit Glasschiebedeckel 133 Liter, außen weiß, innen Aluminium</p> <ul style="list-style-type: none"> · 573 x 573 x 904 mm · Temperatur: -14°C / -24°C · abschließbar · Aluminiumrahmen · mechanisches Thermostat (innen) · inkl. 4 Rollen, davon 2 mit Bremse 	<p>CHV160N</p> 	<p>479,00</p>								
	<table border="1"> <tr> <td>°C</td> <td>L/net</td> <td>kg/net</td> <td>kg/br</td> </tr> <tr> <td>-14/-24</td> <td>107</td> <td>40</td> <td>47</td> </tr> </table>	°C	L/net	kg/net	kg/br	-14/-24	107	40	47		
°C	L/net	kg/net	kg/br								
-14/-24	107	40	47								
 <div style="background-color: red; color: white; padding: 5px; display: inline-block; font-weight: bold;">NEU</div>	<p>Tiefkühltruhe mit Glasschiebedeckel 208 Liter, außen weiß, innen Aluminium</p> <ul style="list-style-type: none"> · 763 x 653 x 904 mm · Temperatur: -14°C / -24°C · abschließbar · Aluminiumrahmen · mechanisches Thermostat (innen) · inkl. 4 Rollen, davon 2 mit Bremse 	<p>CHV210N</p> 	<p>599,00</p>								
	<table border="1"> <tr> <td>°C</td> <td>L/net</td> <td>kg/net</td> <td>kg/br</td> </tr> <tr> <td>-14/-24</td> <td>170</td> <td>45</td> <td>53</td> </tr> </table>	°C	L/net	kg/net	kg/br	-14/-24	170	45	53		
°C	L/net	kg/net	kg/br								
-14/-24	170	45	53								
 <div style="background-color: red; color: white; padding: 5px; display: inline-block; font-weight: bold;">NEU</div>	<p>Tiefkühltruhe mit Glasschiebedeckel 314 Liter, außen weiß, innen Aluminium</p> <ul style="list-style-type: none"> · 1039 x 653 x 904 mm · Temperatur: -14°C / -24°C · abschließbar · Aluminiumrahmen · mechanisches Thermostat (innen) · inkl. 4 Rollen, davon 2 mit Bremse 	<p>CHV310N</p> 	<p>659,00</p>								
	<table border="1"> <tr> <td>°C</td> <td>L/net</td> <td>kg/net</td> <td>kg/br</td> </tr> <tr> <td>-14/-24</td> <td>258</td> <td>55</td> <td>68</td> </tr> </table>	°C	L/net	kg/net	kg/br	-14/-24	258	55	68		
°C	L/net	kg/net	kg/br								
-14/-24	258	55	68								
 <div style="background-color: red; color: white; padding: 5px; display: inline-block; font-weight: bold;">NEU</div>	<p>Tiefkühltruhe mit Glasschiebedeckel 416 Liter, außen weiß, innen Aluminium</p> <ul style="list-style-type: none"> · 1314 x 653 x 904 mm · Temperatur: -14°C / -24°C · abschließbar · Aluminiumrahmen · mechanisches Thermostat (innen) · inkl. 4 Rollen, davon 2 mit Bremse 	<p>CHV410N</p> 	<p>739,00</p>								
	<table border="1"> <tr> <td>°C</td> <td>L/net</td> <td>kg/net</td> <td>kg/br</td> </tr> <tr> <td>-14/-24</td> <td>345</td> <td>65</td> <td>79</td> </tr> </table>	°C	L/net	kg/net	kg/br	-14/-24	345	65	79		
°C	L/net	kg/net	kg/br								
-14/-24	345	65	79								

Tiefkühltruhen & Speiseeisverkaufstruhen

	Artikel	Code	Euro								
 <div style="text-align: right; background-color: red; color: white; padding: 5px; font-weight: bold; font-size: 1.2em;">NEU</div>	<p>Tiefkühltruhe mit Glasschiebedeckel 478 Liter, außen weiß, innen Aluminium</p> <ul style="list-style-type: none"> · 1489 x 653 x 904 mm · Temperatur: -14°C / -24°C · abschließbar · Aluminiumrahmen · mechanisches Thermostat (außen) · inkl. 6 Rollen, davon 3 mit Bremse 	<p>CHV510N</p> 	<p>869,00</p>								
	<table border="1" style="width: 100%; text-align: center; font-size: 0.8em;"> <tr> <td>°C</td> <td>L/net</td> <td>kg/net</td> <td>kg/br</td> </tr> <tr> <td>-14/-24</td> <td>400</td> <td>75</td> <td>90</td> </tr> </table>	°C	L/net	kg/net	kg/br	-14/-24	400	75	90		
°C	L/net	kg/net	kg/br								
-14/-24	400	75	90								
 <div style="text-align: right; background-color: red; color: white; padding: 5px; font-weight: bold; font-size: 1.2em;">NEU</div>	<p>Tiefkühltruhe mit Glasschiebedeckel 582 Liter, außen weiß, innen Aluminium</p> <ul style="list-style-type: none"> · 1772 x 653 x 904 mm · Temperatur: -14°C / -24°C · abschließbar · Aluminiumrahmen · mechanisches Thermostat (außen) · inkl. 6 Rollen, davon 3 mit Bremse 	<p>CHV610N</p> 	<p>999,00</p>								
	<table border="1" style="width: 100%; text-align: center; font-size: 0.8em;"> <tr> <td>°C</td> <td>L/net</td> <td>kg/net</td> <td>kg/br</td> </tr> <tr> <td>-14/-24</td> <td>490</td> <td>85</td> <td>105</td> </tr> </table>	°C	L/net	kg/net	kg/br	-14/-24	490	85	105		
°C	L/net	kg/net	kg/br								
-14/-24	490	85	105								
 <div style="text-align: right; background-color: red; color: white; padding: 5px; font-weight: bold; font-size: 1.2em;">NEU</div>	<p>Speiseeisverkaufstruhen 278 Liter</p> <ul style="list-style-type: none"> · 1043 x 659 x 904 mm · Innenmaß: 915 x 529 x 552/658 mm · Temperatur: -14°C / -24 °C · abschließbar · mit Beleuchtung · inkl. 5 Kunststoffbehälter · inkl. 4 Rollen, davon 2 mit Bremse 	<p>EisT310</p>  	<p>929,00</p>								
	<table border="1" style="width: 100%; text-align: center; font-size: 0.8em;"> <tr> <td>°C</td> <td>L/net</td> <td>kg/net</td> <td>kg/br</td> </tr> <tr> <td>-14/-24</td> <td>210</td> <td>55</td> <td>68</td> </tr> </table>	°C	L/net	kg/net	kg/br	-14/-24	210	55	68		
°C	L/net	kg/net	kg/br								
-14/-24	210	55	68								
 <div style="text-align: right; background-color: red; color: white; padding: 5px; font-weight: bold; font-size: 1.2em;">NEU</div>	<p>Speiseeisverkaufstruhen 371 Liter</p> <ul style="list-style-type: none"> · 1318 x 659 x 904 mm · Innenmaß: 1190 x 529 x 552/658 mm · Temperatur: -14°C / -24 °C · abschließbar · mit Beleuchtung · inkl. 7 Kunststoffbehälter · inkl. 4 Rollen, davon 2 mit Bremse 	<p>EisT410</p>  	<p>1.169,00</p>								
	<table border="1" style="width: 100%; text-align: center; font-size: 0.8em;"> <tr> <td>°C</td> <td>L/net</td> <td>kg/net</td> <td>kg/br</td> </tr> <tr> <td>-14/-24</td> <td>283</td> <td>65</td> <td>79</td> </tr> </table>	°C	L/net	kg/net	kg/br	-14/-24	283	65	79		
°C	L/net	kg/net	kg/br								
-14/-24	283	65	79								

Tiefkühltruhen mit Klappdeckel





	Artikel	Code	Euro
 <p>NEU</p> <p>Dual-Modus: Tiefkühlung oder Kühlung</p>	<p>Tiefkühltruhe mit Klappdeckel 122 Liter, Dual-Modus, weiß</p> <ul style="list-style-type: none"> · 575 x 635 x 840 mm · Temperatur: -24°C/+4°C · 230 V, 50 Hz · Dual-Modus: Kühlung oder Tiefkühlung möglich · Mechanisches Thermostat (innen) · Energie-Effizienzklasse (Haushalt) A+ 	<p>CHV115N</p> <p>A+</p> <p>Kältemittel: R600a</p>	<p>359,00</p>
 <p>NEU</p> <p>Dual-Modus: Tiefkühlung oder Kühlung</p>	<p>Tiefkühltruhe mit Klappdeckel 202 Liter, Dual-Modus, weiß</p> <ul style="list-style-type: none"> · 760 x 765 x 840 mm · Dual-Modus: Kühlung oder Tiefkühlung möglich · Temperatur: -24°C/+4°C · mit Beleuchtung · abschließbar · Energie-Effizienzklasse (Haushalt) A+ · Mechanisches Thermostat (innen) · 1 Korb enthalten 	<p>CHV220N</p> <p>A+</p> <p>Kältemittel: R600a</p>	<p>449,00</p>
 <p>NEU</p> <p>Dual-Modus: Tiefkühlung oder Kühlung</p>	<p>Tiefkühltruhe mit Klappdeckel 305 Liter, Dual-Modus, weiß</p> <ul style="list-style-type: none"> · 1035 x 765 x 840 mm · Dual-Modus: Kühlung oder Tiefkühlung möglich · Temperatur: -24°C/+4°C · Verbrauch: 1,183 kW/24h · mit Beleuchtung · abschließbar · 1 Korb enthalten · Energie-Effizienzklasse (Haushalt) A+ · Mechanisches Thermostat (innen) · Trennwand vorhanden 	<p>CHV332N</p> <p>A+</p> <p>Kältemittel: R600a</p>	<p>499,00</p>

°C	L/net	230 V / 50 Hz	kg/net	kg/br
-24/+4	120		32	34

°C	L/net	kg/net	kg/br
-24/+4	195	37	39

°C	L/net	kg/net	kg/br
-24/+4	295	44	47

Tiefkühltruhen mit Klappdeckel





	Artikel	Code	Euro
 <p>NEU</p> <p>Dual-Modus: Tiefkühlung oder Kühlung</p>	<p>Tiefkühltruhe mit Klappdeckel 407 Liter, Dual-Modus, weiß</p> <ul style="list-style-type: none"> · 1310 x 765 x 840 mm · Dual-Modus: Kühlung oder Tiefkühlung möglich · Temperatur: -24°C/+4°C · Energie-Effizienzklasse (Haushalt) A+ · Gefrierkapazität (24h): 18 kg · mit Beleuchtung · abschließbar · Energie-Effizienzklasse (Haushalt) A+ · Mechanisches Thermostat (innen) · Verpackungsmaß: 1537 x 770 x 883 mm 	<p>CHV442N</p> <p>A+</p> <p>Kältemittel: R600a</p>	<p>599,00</p>
 <p>NEU</p> <p>Dual-Modus: Tiefkühlung oder Kühlung</p>	<p>Tiefkühltruhe mit Klappdeckel 469 Liter, Dual-Modus, weiß</p> <ul style="list-style-type: none"> · 1492 x 765 x 840 mm · Dual-Modus: Kühlung oder Tiefkühlung möglich · Temperatur: -24°C/+4°C · Verbrauch: 0,959 kW/24h · Lautstärke: 41db · Energie-Effizienzklasse (Haushalt) A+ · Gefrierkapazität (24h): 18 kg · mit Beleuchtung · Mechanisches Thermostat (innen) · Verpackungsmaß: 1537 x 770 x 883 mm 	<p>CHV550N</p> <p>A+</p> <p>Kältemittel: R600a</p>	<p>699,00</p>
 <p>NEU</p> <p>Dual-Modus: Tiefkühlung oder Kühlung</p>	<p>Tiefkühltruhe mit Klappdeckel 572 Liter, Dual-Modus, weiß</p> <ul style="list-style-type: none"> · 1775 x 765 x 840 mm · Dual-Modus: Kühlung oder Tiefkühlung möglich · Temperatur: -24°C/+4°C · Verbrauch: 1,1 kW/24h · Lautstärke: 41db · Energie-Effizienzklasse (Haushalt) A+ · Gefrierkapazität (24h): 20 kg · mit Beleuchtung · Mechanisches Thermostat (außen) · Verpackungsmaß: 1820 x 770 x 883 mm 	<p>CHV600N</p> <p>A+</p> <p>Kältemittel: R600a</p>	<p>829,00</p>
 <p>NEU</p> <p>Dual-Modus: Tiefkühlung oder Kühlung</p>	<p>Tiefkühltruhe mit Klappdeckel 635 Liter, Dual-Modus, weiß</p> <ul style="list-style-type: none"> · 1899 x 765 x 840 mm · Dual-Modus: Kühlung oder Tiefkühlung möglich · Temperatur: -24°C/+4°C · Verbrauch: 1,183 kW/24h · Lautstärke: 41db · Energie-Effizienzklasse (Haushalt) A+ · Gefrierkapazität (24h): 22 kg · mit Beleuchtung · Mechanisches Thermostat (außen) · Verpackungsmaß: 1959 x 770 x 883 mm 	<p>CHV650N</p> <p>A+</p> <p>Kältemittel: R600a</p>	<p>899,00</p>

Tiefkühltruhen mit Klappdeckel







	Artikel	Code	Euro
	Tiefkühltruhe mit Klappdeckel 466 Liter <ul style="list-style-type: none"> · 1483 x 685 x 940 mm · Innen: 1343 x 492 x 688 mm · 250 W, 230 V, 50 Hz · Temperatur: -18°C · statische Kühlung · manuelle Abtauung · inkl. 2 Körbe 	BD466SS.01 	899,00
			
	Tiefkühltruhe mit Klappdeckel 598 Liter <ul style="list-style-type: none"> · 1603 x 726 x 1030 mm · Innen: 1462 x 524 x 795 mm · 280 W, 230 V, 50 Hz · Temperatur: -18°C · statische Kühlung · manuelle Abtauung · inkl. 2 Körbe 	BD598SS.01 	1.099,00
			
	Tiefkühltruhe mit Klappdeckel 768 Liter <ul style="list-style-type: none"> · 1847 x 796 x 1030 mm · Innen: 1707 x 604 x 755 mm · 300 W, 230 V, 50 Hz · Temperatur: -18°C · statische Kühlung · manuelle Abtauung · inkl. 2 Körbe, abschließbar 	BD768SS.01 	1.229,00
			
	Party-Kühler Edelstahl 50 Liter, für 21 Flaschen <div style="float: right; background-color: red; color: white; padding: 5px; font-weight: bold; font-size: 1.2em;">NEU</div> <ul style="list-style-type: none"> · Ø 503 x 838 mm · Maße mit ausgeklappten Ablagen: 918 x 503 x 838 mm · Temperatur: +4°C/+15°C · 60 W, 230 V, 50 Hz · Lautstärke: 46 dB · 2 verstell- und klappbare Ablagen in schwarz inkl. Hängkörbe für Flaschen · temperierte Glasoberfläche · Steuerelement mit digitalem Display · inklusive Rollen · Verpackungsmaß: 550 x 550 x 880 mm 	PAT-50SS 	429,00
Edelstahl inkl. Rollen			

Flaschen-Kühltruhen +1°C/+10°C

Zum Aufbewahren von Bierflaschen





	Artikel	Code	Euro
	<p>NEU</p> <p>Flaschen-Kühltruhe 133 Liter</p> <ul style="list-style-type: none"> · 573 x 573 x 904 mm · Innenmaß: 463 x 463 x 552 mm · Temperatur: +1°C/+10°C · Aluminiumrahmen · 4 Räder mit 2 Bremsen · mechanisches Thermostat  <p>°C L/net kg/net kg/br +1/+10 107 40 47</p>	<p>KFT160</p> 	<p>479,00</p>
	<p>NEU</p> <p>Flaschen-Kühltruhe 208 Liter</p> <ul style="list-style-type: none"> · 763 x 653 x 904 mm · Innenmaß: 639 x 529 x 552 mm · Temperatur: +1°C/+10°C · Aluminiumrahmen · 4 Räder mit 2 Bremsen · mechanisches Thermostat  <p>°C L/net kg/net kg/br +1/+10 170 45 53</p>	<p>KFT210</p> 	<p>579,00</p>
	<p>NEU</p> <p>Flaschen-Kühltruhe 314 Liter</p> <ul style="list-style-type: none"> · 1043 x 659 x 904 mm · Innenmaß: 915 x 529 x 552 mm · Temperatur: +1°C/+10°C · Aluminiumrahmen · 4 Räder mit 2 Bremsen · mechanisches Thermostat  <p>°C L/net kg/net kg/br +1/+10 258 55 62</p>	<p>KFT310</p> 	<p>629,00</p>

Eismaschinen / Eiswürfelbereiter

	Artikel	Code	Euro
	<p>Eismaschine 2 Liter, silber</p> <ul style="list-style-type: none"> · 284 x 424 x 262 mm · Temperatur: -18°C/-35°C · 180 W, 230 V, 50 Hz · vollautomatisch, Fassungsvermögen: 2 Liter · für Speiseeis, Sorbets & Frozen Joghurt · LCD Display, digitaler Timer · Produktionszyklus in 1 Stunde · erfordert kein Eis oder vorheriges Einfrieren · extra breite & tiefe Schüssel für einfaches Löffeln · erweiterte Kühlfunktion (10 Min.) · Verpackungsmaß: 353 x 496 x 324 mm 	<p>EIS15</p>  	<p>389,00</p>
	<p>Eismaschine 2 Liter, silber</p> <ul style="list-style-type: none"> · 272 x 315 x 362 mm · Temperatur: -18°C/-35°C · 180 W, 230 V, 50 Hz · vollautomatisch, Fassungsvermögen: 2 Liter · für Speiseeis, Sorbets & Frozen Joghurt · LCD Display, digitaler Timer · Produktionszyklus in 1 Stunde · erfordert kein Eis oder vorheriges Einfrieren · extra breite & tiefe Schüssel für einfaches Löffeln · erweiterte Kühlfunktion (20 Min.) · Verpackungsmaß: 390 x 330 x 432 mm 	<p>EIS20</p>  	<p>399,00</p>
	<p>Eiswürfelbereiter 3,2 Liter, silber, Fingereis</p> <ul style="list-style-type: none"> · 297 x 367 x 378 mm · 130 W, 230 V, 50 Hz · Kapazität: 15 kg/24 h, Eisvorrat: 1 kg · Gewicht eines Eiswürfels: 10–12 g · Dauer eines Produktionszyklus: 6–15 Minuten · 9 Eiswürfel pro Produktionszyklus · manuelle Wasserbefüllung · Wasser- und Füllstandskontrolle · Verpackungsmaß: 343 x 406 x 430 mm 	<p>ZB-15A</p>	<p>279,00</p>
	<p>Eiswürfelbereiter 3,2 Liter, silber, Fingereis</p> <ul style="list-style-type: none"> · 380 x 435 x 431 mm · 180 W, 230 V, 50 Hz · Kapazität: 20 kg/24 h, Eisvorrat: 1,2 kg · Gewicht eines Eiswürfels: 10–12 g · Dauer eines Produktionszyklus: 7–15 Minuten · 12 Eiswürfel pro Produktionszyklus · manuelle Wasserbefüllung · Wasser- und Füllstandskontrolle · Verpackungsmaß: 420 x 485 x 472 mm 	<p>ZB-20A</p>	<p>309,00</p>





Eiswürfelbereiter

	Artikel	Code	Euro
	<p>Eiswürfelbereiter aus Edelstahl</p> <ul style="list-style-type: none"> · 398 x 540 x 682 mm · 240 W, 230 V, 1,9 kW/24 h · autom. Lauf mit Wassermangel- und Überladungsschutz · Produktion: 25 kg/24 h · Kapazität: 6 kg · Verpackungsmaß: 457 x 621 x 710 mm 	IM-25	729,00
	<p>Eiswürfelbereiter aus Edelstahl</p> <ul style="list-style-type: none"> · 548 x 611 x 823 mm · 380 W, 230 V, 3 kW/24 h · autom. Lauf mit Wassermangel- und Überladungsschutz · Produktion: 50 kg/24 h · Kapazität: 13 kg · Verpackungsmaß: 600 x 625 x 872 mm 	IM-50	959,00
	<p>Eiswürfelbereiter aus Edelstahl</p> <ul style="list-style-type: none"> · 548 x 610 x 823 mm · 380 W, 230 V, 3 kWh/24 h · autom. Lauf mit Wassermangel- und Überladungsschutz · Produktion: 80 kg/24 h · Kapazität: 13 kg · Verpackungsmaß: 625 x 690 x 872 mm 	IM-80	1.649,00
	<p>Eiswürfelbereiter aus Edelstahl</p> <ul style="list-style-type: none"> · 682 x 610 x 1050 mm · 380 W, 230 V, 3 kWh/24 h · autom. Lauf mit Wassermangel- und Überladungsschutz · Produktion: 100 kg/24 h · Kapazität: 55 kg · Verpackungsmaß: 750 x 685 x 1100 mm 	IM-100	1.899,00

 240 W
  230 V / 50 Hz
  1,9 kWh
  30 kg/net
  32 kg/br

 380 W
  230 V / 50 Hz
  3 kWh
  47 kg/net
  52 kg/br

 380 W
  230 V / 50 Hz
  3 kWh
  50 kg/net
  55 kg/br

 380 W
  230 V / 50 Hz
  3 kWh
  80 kg/net
  85 kg/br



BREMA macht das Eis!



Eis machen ist unser Handwerk

Alle BREMA Eismaschinen sind TÜV Rheinland und CE zertifiziert. Außerdem haben wir die Zertifizierungen NSF, ETL, Listed Mark, ETL Sanitation Mark, KC, UKR, S- Mark, WRAS und RCM.

Wir sind CSQ zertifiziert entsprechend der Norm UNI EN ISO 9001:2008.

Allen unseren Maschinen liegt bei:

- CE Konformitätserklärung
- Installations- und Bedienungsanleitung in 19 Sprachen
- Anleitung zur Reinigung und Desinfektion der Eismaschine

Zubehör für jede Maschine: • Wasserzu- und Ablaufschlauch • Eisschaufel • Füße

Das Wichtigste in aller Kürze:

Ice Cube, Kegeleis Serie MICE, CB, C & Spezial / Tagesleistung 22 - 300 kg:

Klarer, fester Kegel (13,18, 33, 42 oder 63 Gramm) einzeln geformt, entsteht durch das Sprühen von Wasser in einen Verdampfer. Der Kegel kühlt schnell, verwässert den Drink nur langsam und hält lange.

Einsatz: Hotel, Restaurant, Bar, Disco, Café

Fast Ice, Eiswürfel, Serie VB & VM / Tagesleistung 105 - 770 kg:

Klarer Eiswürfel in Pyramidenform, ca. 7 Gramm schwer. Produziert mit einem vertikalen Verdampfer, eine der effektivsten Eisproduktionsmethoden, überall dort wo viel Eis gebraucht wird. Die große Oberfläche ermöglicht eine sehr schnelle Kühlung für ganz verschiedene Anwendungen. Spezifisches Volumen: 1m³ = 530 kg

Einsatz: Fast Food Restaurants, Hotel, Disco, Autobahn- und Kaufhausgastronomie, Catering, Fischpräsentation/-lagerung, Supermarkt

Ice Finger, Fingereis, Serie IMF / Tagesleistung 25 - 75 kg:

Klarer, fester, hohler 20 Gramm Kegel, einzeln geformt, entsteht durch die Eisproduktion mit Paddelsystem. Perfekter Betrieb der Maschine auch bei besonders hartem, kalkhaltigem oder unreinem Wasser gesichert. Paddelmaschinen haben weder Pumpen noch Spritzdüsen und machen daher im Gegensatz zu den Maschinen mit Sprühtechnik keine häufigen periodischen Wartungseingriffe zur Reinigung und Entkalkung erforderlich. Der Kegel kühlt schnell, verwässert den Drink nur langsam und hält lange.

Einsatz: Hotel, Restaurant, Bar, Disco, Café

Ice Pebbles, Cocktaileis, Serie TB & TM / Tagesleistung 55 - 440 kg:

Der Nugget wird als gepresstes Flockeneis in einem doppelwandigen, wartungsfreien Edelstahlverdampfer hergestellt. Es entstehen harte, einheitliche Nuggets ca. 8x16x7 mm. Ideal für verschiedenste Anforderungen. Spezifisches Volumen: 1m³ = 550 kg

Einsatz: Hotel, Restaurant, Fast Food Restaurants, Cocktailbars, Disco, Sauna, Medizin, Fischpräsentation/-lagerung, Bäckerei, Supermarkt, Industrie

Ice Flakes, Flockeneis, Serie MICE & G / Tagesleistung 60 - 1400 kg:

Flockeneis wird in einem stehenden, doppelwandigen, wartungsfreien Edelstahlverdampfer mit rotierender Schnecke hergestellt. Es entsteht Eis in seiner natürlichsten Form, ca. -0,5°C kalt. Die Anwendungsbereiche sind vielfältig. Spezifisches Volumen: 1m³ = 550 kg

Einsatz: Hotel, Restaurant, Sauna, Medizin, Fischpräsentation/-lagerung, Bäckerei, Supermarkt, Industrie

Ice Scales, Scherbeneis, Serie Muster / Tagesleistung 250 - 2200 kg:

Um einen stehenden, tiefgekühlten Metallzylinder-Verdampfer rotiert ein Sprüharm-/Eisabkratzsystem. Bei jeder Umdrehung werden trockene, ausgefrorene Eisscherben, ca. 1,5-3 mm, -5 °C bis etwa -10 °C kalt, abgeworfen. Der Verdampfer wird gleichzeitig wieder neu mit Wasser für die nächste Scherbeneisproduktion besprüht. Durch den feststehenden Verdampfer entfallen kostenintensive Wartungs- und Servicearbeiten im Vergleich zum Wettbewerb!

Spezifisches Volumen: 1m³ = 430 kg

Einsatz: Fleisch-/Wurstproduktion, Fischpräsentation/-lagerung, Bäckerei, Supermarkt, Industrie, Sauna, Medizin

Allgemeine Verkaufsbedingungen

- Standardspannung: 220-240 V / 50 Hz (Modelle mit Sonderspannung (230/60/1,400/50/3) auf Anfrage lieferbar)
- Kältemittel: R290 oder R404A (siehe Produktbeschreibung)

R290 ist das neue, umweltfreundliche Kältemittel.

- Die Leistungsangaben beziehen sich auf 21 °C Umgebungstemperatur und 15 °C Wasserzulauftemperatur.
- **Garantie:** 2 Jahre Materialgarantie
- Ein evtl. Rückversand muss durch GGG genehmigt werden
- Die Installation an Versorgungsleitungen (Strom, Wasser, Abwasser) darf nur von konzessionierten örtlichen Fachfirmen vorgenommen werden.
- Es besteht keine Haftung für Schäden die durch Nichtbeachtung dieser Regelung entstehen.
- Technische Änderungen durch GGG vorbehalten. Für Druckfehler wird keine Haftung übernommen.
- Die Verantwortung für die Abholung der Ware liegt beim Käufer.



Kegeleisenerzeuger

MICE & CB Serie

A = Luftkühlung, W = Wasserkühlung

MICE18.01



MICE24.01



CB 249.01



MICE30.01



Eisproduktion/Tag* ca.	22 kg	26 kg	29 kg	35 kg
Behälterkapazität ca.	4 kg ≈ 310 Stück	6 kg ≈ 350 Stück	9 kg ≈ 530 Stück	16 kg ≈ 950 Stück
Kondensator typ	A - W	A - W	A - W	A - W
Eiskegeltyp	D-13g	A-18g, C-33g, D-13g, E-42g	A-18g, C-33g, D-13g, E-42g	A-18g, C-33g, D-13g, E-42g
Anschluss**	320 W	350 W	370 W	370 W
Sicherung	10 A	10 A	10 A	10 A
Kältemittel	R290	R290	R290	R290
Maße (B/T/H)	355 x 404 x 590 mm*	390 x 460 x 610 mm*	390 x 460 x 690 mm*	500 x 580 x 690 mm**
Gewicht netto	27,5 kg	35 kg	37 kg	48 kg
Ausführung	ABS grau oder blau oder Edelstahl AISI 304, Scotch Brite	Edelstahl AISI 304, Scotch Brite	Edelstahl AISI 304, Scotch Brite	Edelstahl AISI 304, Scotch Brite
Besonderheit	automatisches Reinigungssystem	automatisches Reinigungssystem	automatisches Reinigungssystem	automatisches Reinigungssystem
Optional	–	Ablaufpumpe	Ablaufpumpe	Ablaufpumpe
Preis	1.079 €	1.289 €	1.299 €	1.539 €



Kegeleisenerzeuger

MICE & CB Serie

A = Luftkühlung, W = Wasserkühlung

CB 416.01



MICE45.01



MICE60.01



CB 674.01



Eisproduktion/Tag* ca.	44 kg	47 kg	67 kg	67 kg
Behälterkapazität ca.	16 kg ≈ 950 Stück	25 kg ≈ 1470 Stück	40 kg ≈ 2350 Stück	40 kg ≈ 2350 Stück
Kondensator typ	A - W	A - W	A - W	A - W
Eiskegeltyp	A-18g, C-33g, D-13g, E-42g	A-18g, C-33g, D-13g, E-42g	A-18g, C-33g, D-13g, E-42g	A-18g, C-33g, D-13g, E-42g
Anschluss**	450 W	500 W	650 W	650 W
Sicherung	10 A	10 A	10 A	10 A
Kältemittel	R290	R290	R290	R290
Maße (B/T/H)	500 x 580 x 690 mm**	500 x 580 x 800 mm**	738 x 600 x 920 mm**	738 x 600 x 851,5 mm**
Gewicht netto	52 kg	56 kg	77 kg	72 kg
Ausführung	Edelstahl AISI 304, Scotch Brite	Edelstahl AISI 304, Scotch Brite	Edelstahl AISI 304, Scotch Brite	Edelstahl AISI 304, Scotch Brite
Besonderheit	automatisches Reinigungssystem	automatisches Reinigungssystem	automatisches Reinigungssystem	automatisches Reinigungssystem
Optional	Ablaufpumpe	Ablaufpumpe	Ablaufpumpe	Ablaufpumpe
Preis	1.669 €	1.769 €	2.389 €	2.289 €



Kegeleiserzeuger

CB Serie

A = Luftkühlung, W = Wasserkühlung

MICE840.01



MICE90.01



MICE130.01



MICE150.01



Eisproduktion/Tag* ca.	85 kg	95 kg	130 kg	155 kg
Behälterkapazität ca.	40 kg ≈ 2350 Stück	55 kg ≈ 3240 Stück	65 kg ≈ 3830 Stück	65 kg ≈ 3830 Stück
Kondensator typ	A - W	A - W	A - W	A - W
Eiskegeltyp	A-18g, C-33g, D-13g, E-42g	A-18g, C-33g, D-13g, E-42g	A-18g, C-33g, D-13g, E-42g, B-60g	A-18g, C-33g, D-13g, E-42g, B-60g
Anschluss**	800 W	850 W	1050 W	1400 W
Sicherung	10 A	10 A	16 A	16 A
Kältemittel	R290	R290	R290	R290
Maße (B/T/H)	738 x 600 x 920 mm**	738 x 600 x 1020 mm**	840 x 740 x 1075 mm**	840 x 740 x 1075 mm**
Gewicht netto	86 kg	89 kg	113 kg	118 kg
Ausführung	Edelstahl AISI 304, Scotch Brite	Edelstahl AISI 304, Scotch Brite	Edelstahl AISI 304, Scotch Brite	Edelstahl AISI 304, Scotch Brite
Besonderheit	automatisches Reinigungssystem	automatisches Reinigungssystem	automatisches Reinigungssystem	automatisches Reinigungssystem
Optional	Ablaufpumpe	Ablaufpumpe	Ablaufpumpe	Ablaufpumpe
Preis	2.499 €	2.699 €	3.349 €	3.599 €



Kegeleiserzeuger

C Serie

A = Luftkühlung, W = Wasserkühlung

C 150



C 300



Eisproduktion/Tag* ca.	85 kg	155 kg
Behälterkapazität ca.	40 kg ≈ 2350 Stück	65 kg ≈ 3830 Stück
Kondensator typ	A - W	A - W
Eiskegeltyp	A-18g, C-33g, D-13g, E-42g	A-18g, C-33g, D-13g, E-42g, B-60g
Anschluss**	800 W	1400 W
Sicherung	10 A	16 A
Kältemittel	R404A	R404A
Maße (B/T/H)	738 x 600 x 920 mm**	840 x 740 x 1075 mm**
Gewicht netto	86 kg	118 kg
Ausführung	Edelstahl AISI 304, Scotch Brite	Edelstahl AISI 304, Scotch Brite
Preis	3.359 €	5.319 €



Kegeleiserzeuger

Special Serie

A = Luftkühlung, W = Wasserkühlung

IC 18



IC 24



Fresh Maker



HIKU 26



DSS 42



Eisproduktion/Tag* ca.	22 kg	26 kg	22 kg	22 kg	44 kg
Behälterkapazität ca.	4 kg ≈ 310 Stück	6 kg ≈ 350 Stück	4 kg ≈ 310 Stück	7 kg	12 kg ≈ 930 Stück
Kondensator typ	A	A	W	A - W	A - W
Eiskegeltyp	D-13g	A-18g, D-13g	D-13g	D-13g	D-13g
Anschluss**	320 W	350 W	320 W	250 W	450 W
Sicherung	10 A	10 A	10 A	10 A	10 A
Kältemittel	R404A	R404A	R404A	R404A	R404A
Maße (B/T/H)	540 x 430 x 470 mm*	595 x 510 x 502 mm*	540 x 430 x 435 mm*	395 x 530 x 790 mm*	500 x 630 x 920 mm
Gewicht netto	34 kg	41 kg	37,5 kg	41 kg	66 kg
Ausführung	Edelstahl AISI 304, Scotch Brite	Edelstahl AISI 304, Scotch Brite	Edelstahl AISI 304, Scotch Brite	Polyethylen	Edelstahl AISI 304, Scotch Brite
Preis	1.319 €	1.589 €	1.599 €	2.339 €	2.839 €



Würfeleiserzeuger

VB - VM Serie

A = Luftkühlung, W = Wasserkühlung

VB250



VM 350



VM 500



VM 900



VM 1700



Eisproduktion/Tag* ca.	105 kg	140 kg	200 kg	400 kg	770 kg
Behälterkapazität ca.	35 ≈ 5000	–	–	–	–
Kondensator typ	A - W	A - W	A - W	A - W	A
Eiskegeltyp	7g	7g	7g	7g	7g
Anschluss**	850 W	1400 W	1600 W	3000 W	4300 W
Sicherung	10 A	16 A	20 A	32 A	32 A
Empf. Behälter	–	Bin 110, 200, 240PE	Bin 240PE, 200, 350 - DRB 100	Bin 240PE, 200, 350 - DRB 100	Bin 350
Kältemittel	R404A	R404A	R404A	R404A	R404A
Maße (B/T/H)	738 x 600 x 980 mm**	540 x 544 x 747 mm	770 x 550 x 805 mm	770 x 550 x 805 mm	1250 x 645 x 950 mm
Gewicht netto	75 kg	73 kg	90 kg	113 kg	186 kg
Ausführung	Edelstahl AISI 304, Scotch Brite	Edelstahl AISI 304, Scotch Brite	Edelstahl AISI 304, Scotch Brite	Edelstahl AISI 304, Scotch Brite	Edelstahl AISI 304, Scotch Brite
Preis	2.599 €	2.699 €	3.399 €	4.499 €	9.329 €



Fingereiserzeuger

IMF Serie

A = Luftkühlung, W = Wasserkühlung

IMF 26.01



IMF 28.01



IMF 35.01



IMF 58.01



IMF 80



Eisproduktion/Tag* ca.	25 kg	25 kg	35 kg	50 kg	75 kg
Behälterkapazität ca.	4 kg	8 kg	15 kg	20 kg	30 kg
Kondensator typ	A - W	A - W	A - W	A - W	A - W
Eiskegeltyp	A-20g	A-20g	A-20g	A-20g	A-20g
Anschluss**	310 W	310 W	310 W	420 W	480 W
Sicherung	10 A	10 A	10 A	10 A	10 A
Kältemittel	R290	R290	R290	R290	R404A
Maße (B/T/H)	385 x 468 x 607 mm*	385 x 468 x 687 mm*	495 x 580 x 687 mm**	495 x 580 x 797 mm**	735 x 596 x 907 mm**
Gewicht netto	36 kg	38 kg	47 kg	54 kg	75 kg
Ausführung	Edelstahl AISI 304, Scotch Brite	Edelstahl AISI 304, Scotch Brite	Edelstahl AISI 304, Scotch Brite	Edelstahl AISI 304, Scotch Brite	Edelstahl AISI 304, Scotch Brite
Preis	1.489 €	1.519 €	1.789 €	1.939 €	2.499 €



COCKTAILLEISERZEUGER

TB SERIE

A = Luftkühlung, W = Wasserkühlung

TB 551.01



TB 852.01



TB 1404.01



TB 1405.01



Eisproduktion/Tag* ca.	55 kg	85 kg	140 kg	140 kg
Behälterkapazität ca.	10 kg	20 kg	40 kg	50 kg
Kondensator typ	A - W	A - W	A - W	A - W
Nuggetmaß ca.	8 x 16 x 7 mm	8 x 16 x 7 mm	8 x 16 x 7 mm	8 x 16 x 7 mm
Anschluss**	420 W	550 W	650 W	650 W
Sicherung	10 A	10 A	10 A	10 A
Kältemittel	R290	R290	R290	R290
Maße (B/T/H)	450 x 620 x 680 mm*	500 x 660 x 690 mm**	738 x 690 x 851,5 mm**	738 x 690 x 1020 mm**
Gewicht netto	56 kg	59 kg	90 kg	94 kg
Ausführung	Edelstahl AISI 304, Scotch Brite	Edelstahl AISI 304, Scotch Brite	Edelstahl AISI 304, Scotch Brite	Edelstahl AISI 304, Scotch Brite
Preis	2.699 €	3.979 €	3.219 €	3.399 €



Cocktailerzeuger

TM Serie

A = Luftkühlung, W = Wasserkühlung

TM 140.01



TM 250.01



TM 450.01



Eisproduktion/Tag* ca.	140 kg	250 kg	440 kg
Kondensator typ	A - W	A - W	A - W
Nuggetmaß ca.	8 x 16 x 7 mm	13 x 18 x 13 mm	16,5 x 18 x 11 mm
Anschluss**	650 W	1050 W	1700 W
Sicherung	10 A	10 A	16 A
Empf. Behälter	Bin 240PE, 110, 200, RB 10	Bin 240PE, 110, 200, 350, RB 100, DRB 100	Bin 240PE, 110, 200, 350, 550V DS RB 100, DRB 100/500/1200
Kältemittel	R404A	R290	R404A
Maße (B/T/H)	560 x 569 x 600 mm	560 x 569 x 695 mm	560 x 569 x 695 mm
Gewicht netto	56 kg	59 kg	90 kg
Ausführung	Edelstahl AISI 304, Scotch Brite	Edelstahl AISI 304, Scotch Brite	Edelstahl AISI 304, Scotch Brite
Preis	3.219 €	4.639 €	5.599 €



Flockeneiserzeuger

MICE Serie

A = Luftkühlung, W = Wasserkühlung

MICE60AS.01



MICE90AS.01



MICE90ASA.01



MICE150AS.01



MICE150ASA.01



Eisproduktion/Tag* ca.	60 kg	95 kg	95 kg	155 kg	155 kg
Behälterkapazität ca.	9 kg	20 kg	30 kg	55 kg	40 kg
Kondensator typ	A - W	A - W	A - W	A - W	A - W
Anschluss**	420 W	550 W	550 W	650 W	650 W
Sicherung	10 A	10 A	10 A	10 A	10 A
Kältemittel	R290	R290	R290	R290	R290
Maße (B/T/H)	450 x 620 x 680 mm*	500 x 660 x 690 mm**	500 x 660 x 800 mm**	738 x 690 x 1020 mm**	738 x 690 x 920 mm**
Gewicht netto	56 kg	59 kg	67 kg	94 kg	85 kg
Ausführung	Edelstahl AISI 304, Scotch Brite	Edelstahl AISI 304, Scotch Brite	Edelstahl AISI 304, Scotch Brite	Edelstahl AISI 304, Scotch Brite	Edelstahl AISI 304, Scotch Brite
Preis	2.559 €	3.099 €	2.919 €	3.599 €	3.229 €



Flockeneiszerzeuger

G Serie

A = Luftkühlung, W = Wasserkühlung

G 160.01



G 280.01



G 510.01



G 1000



Eisproduktion/Tag* ca.	60 kg	95 kg	95 kg	155 kg
Behälterkapazität ca.	9 kg	20 kg	30 kg	40 kg
Kondensatortyp	A - W	A - W	A - W	A - W
Anschluss**	420 W	550 W	550 W	650 W
Sicherung	10 A	10 A	10 A	10 A
Kältemittel	R290	R290	R290	R404A
Maße (B/T/H)	450 x 620 x 680 mm*	500 x 660 x 690 mm**	500 x 660 x 800 mm**	738 x 690 x 920 mm**
Gewicht netto	56 kg	59 kg	67 kg	85 kg
Ausführung	Edelstahl AISI 304, Scotch Brite	Edelstahl AISI 304, Scotch Brite	Edelstahl AISI 304, Scotch Brite	Edelstahl AISI 304, Scotch Brite
Preis	3.159 €	4.349 €	5.149 €	10.839 €



Scherbeneiszerzeuger

Muster Serie

A = Luftkühlung, W = Wasserkühlung

Muster 250



Muster 350



Muster 600



Eisproduktion/Tag* ca.	250 kg	400 kg	620 kg
Kondensatortyp	A - W	A - W	A - W
Anschluss**	1700 W	2100 W	3000 W
Sicherung	16 A	16 A	16 A
Empf. Behälter	Bin 200, 350	Bin 350, 550V DS; DRB 100	Bin 350, Bin 550V DS; DRB 100, 500, 1200
Kältemittel	R404A	R404A	R404A
Maße (B/T/H)	870 x 550 x 600 mm	900 x 588 x 705 mm	900 x 588 x 705 mm
Gewicht netto	100 kg	137 kg	151 kg
Ausführung	Edelstahl AISI 304, Scotch Brite	Edelstahl AISI 304, Scotch Brite	Edelstahl AISI 304, Scotch Brite
Preis	7.809 €	8.419 €	10.019 €



Scherbeneiserzeuger

Muster Serie

A = Luftkühlung, W = Wasserkühlung

Muster 800



Muster 1500



Muster 2000



Eisproduktion/Tag* ca.	900 kg	1500 kg	2300 kg
Kondensator typ	A - W	A - W	A
Anschluss	4600 W **	6000 W ***	7000 W ***
Sicherung	16 A	32 A	32 A
Empf. Behälter	Bin 550V DS; DRB 500, 1200	Bin 550V DS; DRB 500, 1200	–
Kältemittel	R404A	R404A	R404A
Maße (B/T/H)	1107 x 700 x 880 mm	1107 x 700 x 970 mm	1062 x 832 x 1423 mm
Gewicht netto	241 kg	306 kg	520 kg
Ausführung	Edelstahl AISI 304, Scotch Brite	Edelstahl AISI 304, Scotch Brite	Edelstahl AISI 304, Scotch Brite
Preis	13.059 €	21.119 €	29.079 €



Vorratsbehälter ICE Bin

Bin Serie

ID 70



Bin 240 PE



Bin 110



Eisproduktion/Tag* ca.	18 - 21 kg	180 kg	100 kg
Würfelgröße	7g, 13 x 18 x 13 mm	–	–
Anschluss**	240 W	–	–
Maschinen-Speicher-Kombination	VM 350; TM 250	C 150; VM 350, 500, 900; G 160, 280, 510, 510 Split, 700 Split CO ₂ ; TM 140, 250, 450	VM 350; G 160, 280, 510, 510 Split, 700 Split CO ₂ ; TM 140, 250, 450
Maße (B/T/H)	568 x 799 x 817 mm	942 x 796 x 1053 mm***	560 x 815 x 1000 mm***
Gewicht netto	58 kg	61 kg	53 kg
Ausführung	Edelstahl AISI 304, Scotch Brite	Polyethylen, lebensmittelsicher	Edelstahl AISI 304, Scotch Brite
Preis	2.509 €	1.219 €	1.219 €



Vorratsbehälter ICE Bin

Bin Serie

Bin 200



Bin 350



Bin 550 V DS



Eisproduktion/Tag* ca.	200 kg	350 kg	550 kg
Maschinen-Speicher-Kombination	C 150; VM 350, 500, 900; G 160, 280, 510, 510 split, 700 split CO ₂ ; TM 140, 250, 450; M 250	C 150, 300, 300 Split; VM 500, 900, 1700; G 160, 280, 510, 510 split, 700 split CO ₂ ; TM 140, 250, 450; M 250, 350, 600, 350 Split, 600 Split, 600 Split CO ₂	G 510, 510 split, 700 split CO ₂ , 1000, 1000 Split, 1400 Split CO ₂ ; TM 450; M 350, 600, 800, 1500, 350 Split, 600 Split, 600 Split CO ₂ , 800 Split, 1000 Split CO ₂ , 1500 Split, 1500 Split CO ₂
Maße (B/T/H)	870 x 790 x 1000 mm***	1250 x 790 x 1000 mm***	1110 x 1060 x 1875 mm
Gewicht netto	74 kg	105 kg	163 kg
Ausführung	Edelstahl AISI 304, Scotch Brite	Edelstahl AISI 304, Scotch Brite	Edelstahl AISI 304, Scotch Brite
Preis	1.539 €	2.289 €	4.689 €



Eistransportsystem ICE Bin

Bin Serie

RB 100



DRB 100



DRB 500



DRB 1200



Kapazität Wagen ca.	108 kg	2x 108 kg	2x 108 kg	2x 108 kg
Speicher bis	+ 17 kg	+ 50 kg	+ 300 kg	+ 1000 kg
Maschinen-Speicher-Kombination	G 160, 280, 510, 510 Split, 700 Split CO ₂ ; TM 140, 250, 450	VM 500, 900; G 280, 510, 510 Split, 700 Split CO ₂ ; TM 250, 450; M 350, 600, 350 Split, 600 Split, 600 Split CO ₂	G 510, 510 Split, 700 Split CO ₂ , 1000, 1000 Split, 1400 Split CO ₂ ; TM 450; M 600, 800, 1500, 600 Split, 600 Split CO ₂ , 800 Split, 1000 Split CO ₂ , 1500 Split, 1500 Split CO ₂	G 510, 510 Split, 700 Split CO ₂ , 1000, 1000 Split, 1400 Split CO ₂ ; TM 450; M 600, 800, 1500, 600 Split, 600 Split CO ₂ , 800 Split, 1000 Split CO ₂ , 1500 Split, 1500 Split CO ₂
Maße (B/T/H)	795 x 1060 x 1284 mm	1560 x 1060 x 1484 mm	1560 x 1330 x 1780 mm	1560 x 1330 x 2460 mm
Gewicht netto	64 kg	135 kg	204 kg	251 kg
Preis	2.589 €	5.329 €	10.279 €	13.249 €



Zubehör

Eiskorb für Transportwagen EIT

**Beschreibung**

Ausführung Kunststoff lebensmittelecht, Kapazität Transportwagen: 6 Körbe.

Maße (B/T/H)

250 x 250 x 520 mm

Preis

49 €

Eisbrecher ESB



Notwendig zum Brechen des Eises im Speicher.

–

79 €

Eistransportwagen ETW



Ausführung Kunststoff lebensmittelecht, isoliert. Inkl. 4x Laufräder, davon 2x feststellbar und Abwasserabflußhahn.

670 x 1030 x 875 mm

1.299 €



Eismaschinen, Eiswürfelbereiter

Eismaschine EIS15

**Kapazität****Liter**

2 Liter

Temperatur

18°C / -35°C

Kühlung**Anschluss**

180 W, 230 V, 50 Hz

Maße (B/T/H)

284 x 424 x 262 mm

Gewicht netto

12 kg

Ausstattung

vollautomatisch, LCD-Display, digitaler Timer, Produktionszyklus 1 Stunde

Preis

379 €

Eismaschine EIS20



2 Liter

18°C / -35°C

180 W, 230 V, 52 Hz

272 x 315 x 362 mm

13 kg

vollautomatisch, LCD-Display, digitaler Timer, Produktionszyklus 1 Stunde

389 €

Eiswürfelbereiter ZB-15A



3,2 Liter

-

130 W, 230 V, 50 Hz

297 x 367 x 378 mm

11,2 kg

Gewicht eines Eiswürfels: 10-12 g, Dauer eines Produktionszyklus: 6-15 Minuten

279 €

Eiswürfelbereiter ZB-20A



3,2 Liter

-

180 W, 230 V, 50 Hz

380 x 435 x 431 mm

11,2 kg





Gewicht eines Eiswürfels: 10-12 g, Dauer eines Produktionszyklus: 6-15 Minuten

309 €

Edelstahl - Schnellkühler & Schockfroster



Temperatur von +70°C auf +3°C in maximal 90 min./+70°C auf -18°C in maximal 240 min.

	Artikel	Code	Euro
 <p>3x GN1/1 oder Blech 600 x 400 mm</p>	<p>Schockfroster mit Aggregat 3x GN 1/1</p> <ul style="list-style-type: none"> · 750 x 740 x 720/750 mm · Innenmaß: 600 x 400 x 280 mm · Kapazität: 14 kg (+3°C)/11 kg (-18°C) · 1150 W, 230 V, 50 Hz · Abstand zw. Einschüben 70 mm · Verpackungsmaß: 800 x 800 x 1000 mm 	<p>AT03 ISO</p> <p>Kältemittel: R452a</p> <p>GN 3x 1/1</p>	<p>2.199,00</p>
	<p>1150 W 230 V / 50 Hz 50 kg /net 60 kg /br</p>	<p>Rost: GRIDAT07</p>	<p>29,00</p>
 <p>5x GN1/1 oder Blech 600 x 400 mm</p>	<p>Schockfroster mit Aggregat 5x GN 1/1</p> <ul style="list-style-type: none"> · 750 x 740 x 850/880 mm · Innenmaß: 610 x 400 x 410 mm · Kapazität: 20 kg (+3°C)/15 kg (-18°C) · 1424 W, 230 V, 50 Hz · Abstand zw. Einschüben 70 mm · Verpackungsmaß: 800 x 800 x 1050 mm 	<p>AT05 ISO</p> <p>Kältemittel: R452a</p> <p>GN 5x 1/1</p>	<p>2.489,00</p>
	<p>1424 W 230 V / 50 Hz 60 kg /net 71 kg /br</p>	<p>Rost: GRIDAT07</p>	<p>29,00</p>
 <p>7x GN1/1 oder Blech 600 x 400 mm</p>	<p>Schockfroster mit Aggregat 7x GN 1/1</p> <ul style="list-style-type: none"> · 750 x 740 x 1260/1290 mm · Innenmaß: 610 x 400 x 770 mm · Kapazität: 25 kg (+3°C)/20 kg (-18°C) · 1490 W, 230 V, 50 Hz · Abstand zw. Einschüben 70 mm · Verpackungsmaß: 800 x 800 x 1400 mm 	<p>AT07 ISO</p> <p>Kältemittel: R452a</p> <p>GN 7x 1/1</p>	<p>3.179,00</p>
	<p>1490 W 230 V / 50 Hz 85 kg /net 95 kg /br</p>	<p>Rost: GRIDAT07</p>	<p>29,00</p>
 <p>10x GN1/1 oder Blech 600 x 400 mm</p>	<p>Schockfroster mit Aggregat 10x GN 1/1</p> <ul style="list-style-type: none"> · 750 x 740 x 1260/1290 mm · Innenmaß: 610 x 400 x 770 mm · Kapazität: 25 kg (+3°C)/20 kg (-18°C) · 2100 W, 230 V, 50 Hz · Abstand zw. Einschüben 70 mm · Verpackungsmaß: 800 x 800 x 1400 mm 	<p>AT10 ISO</p> <p>Kältemittel: R452a</p> <p>GN 10x 1/1</p>	<p>3.869,00</p>
	<p>2100 W 230 V / 50 Hz 90 kg /net 101 kg /br</p>	<p>Rost: GRIDAT07</p>	<p>29,00</p>



10

Kühl- & Tiefkühlzellen, Regale

Lagerkühlzellen	152
Konfiskatkühler	153
Fasskühler	154 - 155
Kühlzellen 75 & 80	156 - 159
Tiefkühlzellen 100	160 - 162
Aggregate	163 - 168
Regalsysteme	169 - 187

Lagerkühlzellen

	Artikel	Code	Euro																		
 <p>°C -2/+8</p>	Lager-Kühlzelle Volumen: 0,96 m³ · 935 x 995 x 1850 mm · Innen: 855 x 885 x 1762 mm · 2 Einlegeböden · Verpackungsmaß: 2000 x 1100 x 550 mm	V4-1850	1.659,00																		
	Kühlaggregat · 675 x 495 x 390 mm · Verpackungsmaß: 750 x 570 x 400 mm	10402003	849,00																		
	passendes Einlegerost · 830 x 807 mm	61404045	179,00																		
<table border="0"> <tr> <td>V</td> <td>kg/net</td> <td>kg/br</td> <td>/</td> <td>°C</td> <td>⚡</td> <td>230 V / 50 Hz</td> <td>kg/net</td> <td>kg/br</td> </tr> <tr> <td>0,96 m³</td> <td>122</td> <td>153</td> <td></td> <td>+2/+8</td> <td>343 W</td> <td></td> <td>28</td> <td>33</td> </tr> </table>				V	kg/net	kg/br	/	°C	⚡	230 V / 50 Hz	kg/net	kg/br	0,96 m³	122	153		+2/+8	343 W		28	33
V	kg/net	kg/br	/	°C	⚡	230 V / 50 Hz	kg/net	kg/br													
0,96 m³	122	153		+2/+8	343 W		28	33													
 <p>°C -2/+8</p>	Lager-Kühlzelle Volumen: 1 m³ · 935 x 995 x 2000 mm · Innen: 855 x 885 x 1912 mm · 3 Einlegeböden · Verpackungsmaß: 2000 x 1100 x 550 mm	V4-2000	1.899,00																		
	Kühlaggregat · 675 x 495 x 390 mm · Verpackungsmaß: 750 x 570 x 400 mm	10402003	849,00																		
	passendes Einlegerost · 830 x 807 mm	61404045	179,00																		
<table border="0"> <tr> <td>V</td> <td>kg/net</td> <td>kg/br</td> <td>/</td> <td>°C</td> <td>⚡</td> <td>230 V / 50 Hz</td> <td>kg/net</td> <td>kg/br</td> </tr> <tr> <td>1 m³</td> <td>134</td> <td>165</td> <td></td> <td>+2/+8</td> <td>343 W</td> <td></td> <td>28</td> <td>33</td> </tr> </table>				V	kg/net	kg/br	/	°C	⚡	230 V / 50 Hz	kg/net	kg/br	1 m³	134	165		+2/+8	343 W		28	33
V	kg/net	kg/br	/	°C	⚡	230 V / 50 Hz	kg/net	kg/br													
1 m³	134	165		+2/+8	343 W		28	33													
 <p>°C -2/+8</p>	Lager-Kühlzelle Volumen: 1 m³ · 935 x 995 x 2000 mm · Innen: 855 x 885 x 1912 mm · 2 Edelstahl-Fleischerhaken, 1 Edelstahl-abtropfbehälter · Verpackungsmaß: 2000 x 1100 x 550 mm	V4-2000C	1.899,00																		
	Kühlaggregat · 675 x 495 x 390 mm · Verpackungsmaß: 750 x 570 x 400 mm	10402003	849,00																		
	passendes Einlegerost · 830 x 807 mm	61404045	179,00																		
<table border="0"> <tr> <td>V</td> <td>kg/net</td> <td>kg/br</td> <td>/</td> <td>°C</td> <td>⚡</td> <td>230 V / 50 Hz</td> <td>kg/net</td> <td>kg/br</td> </tr> <tr> <td>1 m³</td> <td>134</td> <td>165</td> <td></td> <td>+2/+8</td> <td>343 W</td> <td></td> <td>28</td> <td>28</td> </tr> </table>				V	kg/net	kg/br	/	°C	⚡	230 V / 50 Hz	kg/net	kg/br	1 m³	134	165		+2/+8	343 W		28	28
V	kg/net	kg/br	/	°C	⚡	230 V / 50 Hz	kg/net	kg/br													
1 m³	134	165		+2/+8	343 W		28	28													

Konfiskatkühler

Allgemeine Beschreibung

- Zelle für die Konservierung von organischen Abfällen
- Temperatur: +2°C/+8°C
- Wandstärke 40 mm
- Wände aus Edelstahl
- FCKW frei
- höhenverstellbare Füße
- PUR-Hartschaum-Isolierung
- Fassungsvermögen für Mülltonnen bis 240 Liter
- ohne Motor

	Artikel	Code	Euro
	Konfiskatkühler Fassungsvermögen für Mülltonnen bis 240 Liter OHNE Motor · 1020 x 870 x 1290 mm · Innen: 655 x 760 x 1130 mm · Wandstärke: 40 mm · Temperatur: +2°C/+8°C, 284 W · Verpackungsmaß: 1200 x 925 x 570 mm	10405001	1.599,00
	Kühlmotor siehe unten	10406001	929,00
<div style="display: flex; justify-content: space-around; align-items: center;"> °C +2 / +8 ⚡ 284 W kg /net 76 kg /br 84 </div>			
	Konfiskatkühler ohne Motor · 1750 x 870 x 1290 mm · Innen: 1385 x 760 x 1130 mm · Wandstärke: 40 mm · Temperatur: +2°C/+8°C, 343 W · Verpackungsmaß: 1515 x 1200 x 570 mm	10405002	2.649,00
	Kühlmotor siehe unten	10406002	989,00
<div style="display: flex; justify-content: space-around; align-items: center;"> °C +2 / +8 ⚡ 343 W kg /net 121 kg /br 134 </div>			
	Hochleistungs-Monoblock Kühlanlage · 285 x 545 x 745 mm · Temperatur: -10°C/+32°C · Edelstahl-Verkleidung · elektronische Steuerung mit digitalem Bedienfeld · automatische Tauwasserverdunstung & Abtauung · Verpackungsmaß: 625 x 365 x 745 mm		
	für Konfiskatkühler 10405001	10406001	929,00
	für Konfiskatkühler 10405002	10406002	989,00
<div style="display: flex; justify-content: space-around; align-items: center;"> °C -10/+32 ⚡ 343 W 230 V / 50 Hz kg /net 29 kg /br 32 </div>			

Fasskühler



Fasskühler

- für max 50 L Fässer, verstärkter Edelstahlboden
- Paneele befestigt mit Haken für schnellen Einbau
- höhenverstellbare FüÙe, PU-Schaum Isolierung 40 mm
- einfacher Zugang für Reinigung und Wartung



leicht entfernbare magnetische Dichtung



Türen mit ergonomischen Griffen













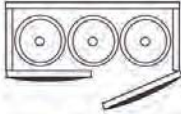
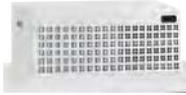







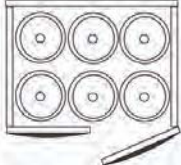
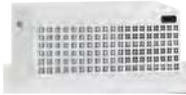







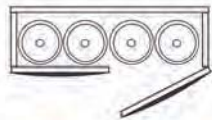





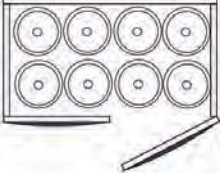

Edelstahlboden

	Artikel	Code	Euro
	2x 1 50 L/2x 2 30 L Fässer · 1060 x 730 x 1060 mm 	10401201	819,00
	Monoblock Kühlanlage · 675 x 495 x 305 mm · Temperatur: +2°C/+8°C · 280 W, 230 V, 50 Hz 	10402201	729,00
	2x 2 50 L/2x 4 30 L Fässer · 1060 x 995 x 1060 mm 	10401202	929,00
	Monoblock Kühlanlage · 675 x 495 x 305 mm · Temperatur: +2°C/+8°C · 280 W, 230 V, 50 Hz 	10402201	729,00

62 / 92 / +2/+8 / 280 W / 230 V / 50 Hz / 25 / 29

75 / 105 / +2/+8 / 280 W / 230 V / 50 Hz / 25 / 29

Fasskühler

	Artikel	Code	Euro
	3x 1 50 L/3x 2 30 L Fässer · 1465 x 730 x 1060 mm 	10401203	989,00
	Monoblock Kühlanlage · 675 x 495 x 305 mm · Temperatur: +2°C/+8°C · 280 W, 230 V, 50 Hz 	  /     	10402201
	3x 2 50 L/3x 4 30 L Fässer · 1465 x 995 x 1060 mm 	10401204	1.179,00
	Monoblock Kühlanlage · 675 x 495 x 305 mm · Temperatur: +2°C/+8°C · 360 W, 230 V, 50 Hz 	  /     	10402202
	4x 1 50 L/4x 2 30 L Fässer · 1870 x 730 x 1060 mm 	10401205	1.229,00
	Monoblock Kühlanlage · 675 x 495 x 305 mm · Temperatur: +2°C/+8°C · 360 W, 230 V, 50 Hz 	  /     	10402202
	4x 2 50 L/4x 4 30 L Fässer · 1870 x 995 x 1060 mm 	10401206	1.379,00
	Monoblock Kühlanlage · 675 x 495 x 305 mm · Temperatur: +2°C/+8°C · 360 W, 230 V, 50 Hz 	  /     	10402202

Kühlzellen 80er Wandstärke, 2000er Höhe

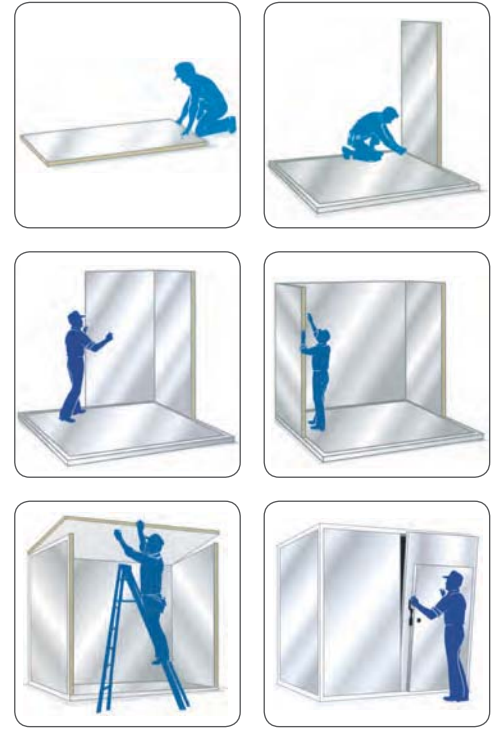

*Aggregat **EL06125N**, **EL07125N** können bei einer Breite von **1200 mm** nicht neben der Tür angebracht werden!

		BREITE					
		1200	1500	1800	2100	2400	3000
TIEFE	3000						
	2400						
	2100						
	1800						
	1500						
	1200						
	900						

Kühlzellen 80er Wandstärke, 2000er Höhe

Maße/Tür-Seite	Wandstärke	Regal CODE	Zelle CODE	Zelle EURO	Kühlaggregat CODE	Kühlaggregat EURO	Komplett EURO
1200 x 900 x 2000 mm	75 mm	KIT001	12 09 20 F	1.599,00 €	EL04123N	1.879,00 €	3.479,00
1200 x 1200 x 2000 mm	75 mm	KIT18	12 12 20 F	1.809,00 €	EL04123N	1.879,00 €	3.688,00
1200 x 1500 x 2000 mm	75 mm	KIT26	12 15 20 F	2.059,00 €	EL04123N	1.879,00 €	3.938,00
1200 x 1800 x 2000 mm	75 mm	KIT31	12 18 20 F	2.279,00 €	EL04123N	1.879,00 €	4.158,00
1200 x 2100 x 2000 mm	75 mm	KIT37	12 21 20 F	2.479,00 €	EL06125N*	2.119,00 €	4.598,00
1200 x 2400 x 2000 mm	75 mm	KIT43	12 24 20 F	2.739,00 €	EL06125N*	2.119,00 €	4.858,00
1200 x 3000 x 2000 mm	75 mm		12 30 20 F	3.209,00 €	EL07125N*	2.119,00 €	5.328,00
1500 x 1200 x 2000 mm	75 mm	KIT26	15 12 20 F	2.069,00 €	EL04123N	1.879,00 €	3.948,00
1500 x 1500 x 2000 mm	75 mm	KIT35	15 15 20 F	2.409,00 €	EL04123N	1.879,00 €	4.288,00
1500 x 1800 x 2000 mm	75 mm	KIT40	15 18 20 F	2.629,00 €	EL06125N	2.119,00 €	4.748,00
1500 x 2100 x 2000 mm	75 mm	KIT48	15 21 20 F	2.864,00 €	EL06125N	2.119,00 €	4.983,00
1500 x 2400 x 2000 mm	75 mm	KIT55	15 24 20 F	3.219,00 €	EL07125N	2.249,00 €	5.468,00
1500 x 3000 x 2000 mm	75 mm		15 30 20 F	3.609,00 €	EL07125N	2.249,00 €	5.858,00
1800 x 1200 x 2000 mm	75 mm	KIT31	18 12 20 F	2.319,00 €	EL04123N	1.879,00 €	4.198,00
1800 x 1500 x 2000 mm	75 mm	KIT40	18 15 20 F	2.659,00 €	EL06125N	2.119,00 €	4.778,00
1800 x 1800 x 2000 mm	75 mm	KIT50	18 18 20 F	2.929,00 €	EL06125N	2.119,00 €	5.048,00
1800 x 2100 x 2000 mm	75 mm	KIT59	18 21 20 F	3.179,00 €	EL07125N	2.249,00 €	5.428,00
1800 x 2400 x 2000 mm	75 mm	KIT67	18 24 20 F	3.489,00 €	EL07125N	2.249,00 €	5.738,00
1800 x 3000 x 2000 mm	75 mm		18 30 20 F	4.009,00 €	EL09125N	2.329,00 €	6.338,00
2100 x 1200 x 2000 mm	75 mm	KIT 37	21 12 20 F	2.529,00 €	EL06125N	2.119,00 €	4.648,00
2100 x 1500 x 2000 mm	75 mm	KIT 48	21 15 20 F	2.899,00 €	EL06125N	2.119,00 €	5.018,00
2100 x 1800 x 2000 mm	75 mm	KIT 59	21 18 20 F	3.189,00 €	EL07125N	2.249,00 €	5.438,00
2100 x 2100 x 2000 mm	75 mm		21 21 20 F	3.449,00 €	EL07125N	2.249,00 €	5.698,00
2100 x 2400 x 2000 mm	75 mm	KIT80	21 24 20 F	3.779,00 €	EL07125N	2.249,00 €	6.028,00
2100 x 3000 x 2000 mm	75 mm		21 30 20 F	4.359,00 €	EL09125N	2.329,00 €	6.688,00
2400 x 1200 x 2000 mm	75 mm	KIT43	24 12 20 F	2.749,00 €	EL06125N	2.119,00 €	4.868,00
2400 x 1500 x 2000 mm	75 mm	KIT55	24 15 20 F	3.159,00 €	EL07125N	2.249,00 €	5.408,00
2400 x 1800 x 2000 mm	75 mm	KIT67	24 18 20 F	3.359,00 €	EL07125N	2.249,00 €	5.608,00
2400 x 2100 x 2000 mm	75 mm	KIT80	24 21 20 F	3.749,00 €	EL07125N	2.249,00 €	5.998,00
2400 x 2400 x 2000 mm	75 mm	KIT90	24 24 20 F	4.109,00 €	EL09125N	2.329,00 €	6.438,00
2400 x 3000 x 2000 mm	75 mm	KIT116	24 30 20 F	4.729,00 €	EL09125N	2.329,00 €	7.058,00
3000 x 1200 x 2000 mm	75 mm		30 12 20 F	3.229,00 €	EL07125N	2.249,00 €	5.478,00
3000 x 1500 x 2000 mm	75 mm		30 15 20 F	3.609,00 €	EL07125N	2.249,00 €	5.858,00
3000 x 1800 x 2000 mm	75 mm		30 18 20 F	3.979,00 €	EL09125N	2.329,00 €	6.308,00
3000 x 2100 x 2000 mm	75 mm		30 21 20 F	4.329,00 €	EL09125N	2.329,00 €	6.658,00
3000 x 2400 x 2000 mm	75 mm	KIT116	30 24 20 F	4.729,00 €	EL09125N	2.329,00 €	7.058,00

Kühlzellen 80er Wandstärke, 2110er Höhe



BREITE

TIEFE

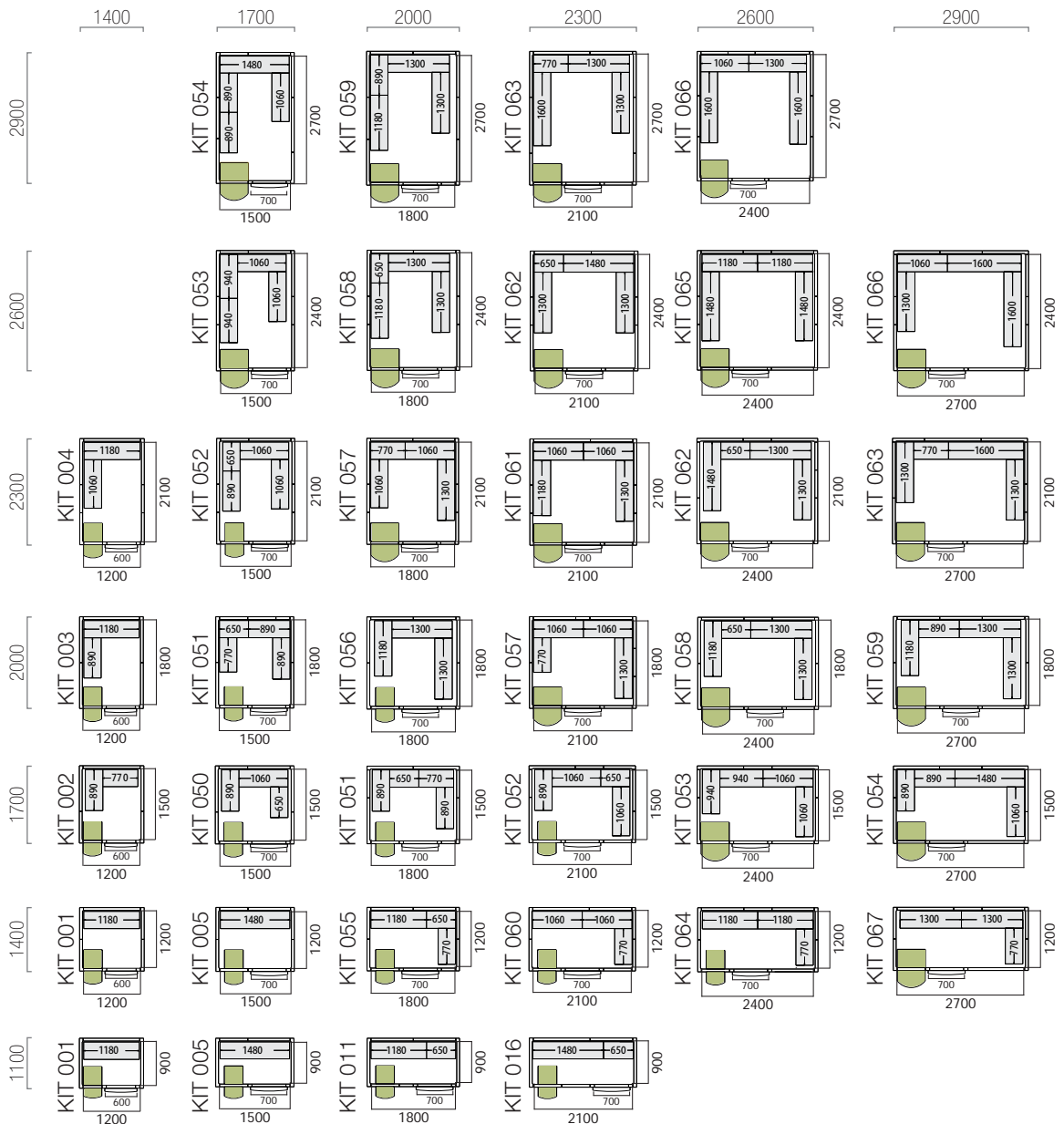

Kühlzellen 80er Wandstärke, 2110er Höhe



Maße/Tür-Seite	Wandstärke	Regal CODE	Zelle CODE	Zelle EURO	Kühlaggregat CODE	Kühlaggregat EURO	Komplett EURO
1400 x 1100 x 2110 mm	80 mm	KIT 001	141121	2.009,00 €	EL04123N	1.879,00 €	3.888,00
1400 x 1400 x 2110 mm	80 mm	KIT 001	141421	2.329,00 €	EL04123N	1.879,00 €	4.208,00
1400 x 1700 x 2110 mm	80 mm	KIT 002	141721	2.629,00 €	EL06125N	2.119,00 €	4.748,00
1400 x 2000 x 2110 mm	80 mm	KIT 003	142021	2.859,00 €	EL06125N	2.119,00 €	4.978,00
1400 x 2300 x 2110 mm	80 mm	KIT 004	142321	3.179,00 €	EL06125N	2.119,00 €	5.298,00

1700 x 1100 x 2110 mm	80 mm	KIT 005	171121	2.329,00 €	EL04123N	1.879,00 €	4.208,00
1700 x 1400 x 2110 mm	80 mm	KIT 005	171421	2.669,00 €	EL06125N	2.119,00 €	4.788,00
1700 x 1700 x 2110 mm	80 mm	KIT 050	171721	2.929,00 €	EL06125N	2.119,00 €	5.048,00
1700 x 2000 x 2110 mm	80 mm	KIT 051	172021	3.229,00 €	EL07125N	2.249,00 €	5.478,00
1700 x 2300 x 2110 mm	80 mm	KIT 052	172321	3.579,00 €	EL07125N	2.249,00 €	5.828,00
1700 x 2600 x 2110 mm	80 mm	KIT 053	172621	3.829,00 €	EL07125N	2.249,00 €	6.078,00
1700 x 2900 x 2110 mm	80 mm	KIT 054	172921	4.169,00 €	EL07125N	2.249,00 €	6.418,00

2000 x 1100 x 2110 mm	80 mm	KIT 011	201121	2.629,00 €	EL04123N	1.879,00 €	4.508,00
2000 x 1400 x 2110 mm	80 mm	KIT 055	201421	2.919,00 €	EL06125N	2.119,00 €	5.038,00
2000 x 2000 x 2110 mm	80 mm	KIT 056	202021	3.539,00 €	EL07125N	2.249,00 €	5.788,00
2000 x 2300 x 2110 mm	80 mm	KIT 057	202321	3.969,00 €	EL07125N	2.249,00 €	6.218,00
2000 x 2600 x 2110 mm	80 mm	KIT 058	202621	4.219,00 €	EL09125N	2.329,00 €	6.548,00
2000 x 2900 x 2110 mm	80 mm	KIT 059	202921	4.449,00 €	EL09125N	2.329,00 €	6.778,00

2300 x 1100 x 2110 mm	80 mm	KIT 016	231121	2.799,00 €	EL06125N	2.119,00 €	4.918,00
2300 x 1400 x 2110 mm	80 mm	KIT 060	231421	3.219,00 €	EL06125N	2.119,00 €	5.338,00
2300 x 2300 x 2110 mm	80 mm	KIT 061	232321	4.269,00 €	EL09125N	2.329,00 €	6.598,00
2300 x 2600 x 2110 mm	80 mm	KIT 062	232621	4.579,00 €	EL09125N	2.329,00 €	6.908,00
2300 x 2900 x 2110 mm	80 mm	KIT 063	232921	5.079,00 €	EL09125N	2.329,00 €	7.408,00

2900 x 1400 x 2110 mm	80 mm	KIT 067	291421	3.739,00 €	EL07125N	2.249,00 €	5.988,00
-----------------------	-------	---------	--------	-------------------	----------	-------------------	-----------------

Tiefkühlzellen 100er Wandstärke, 2150er Höhe

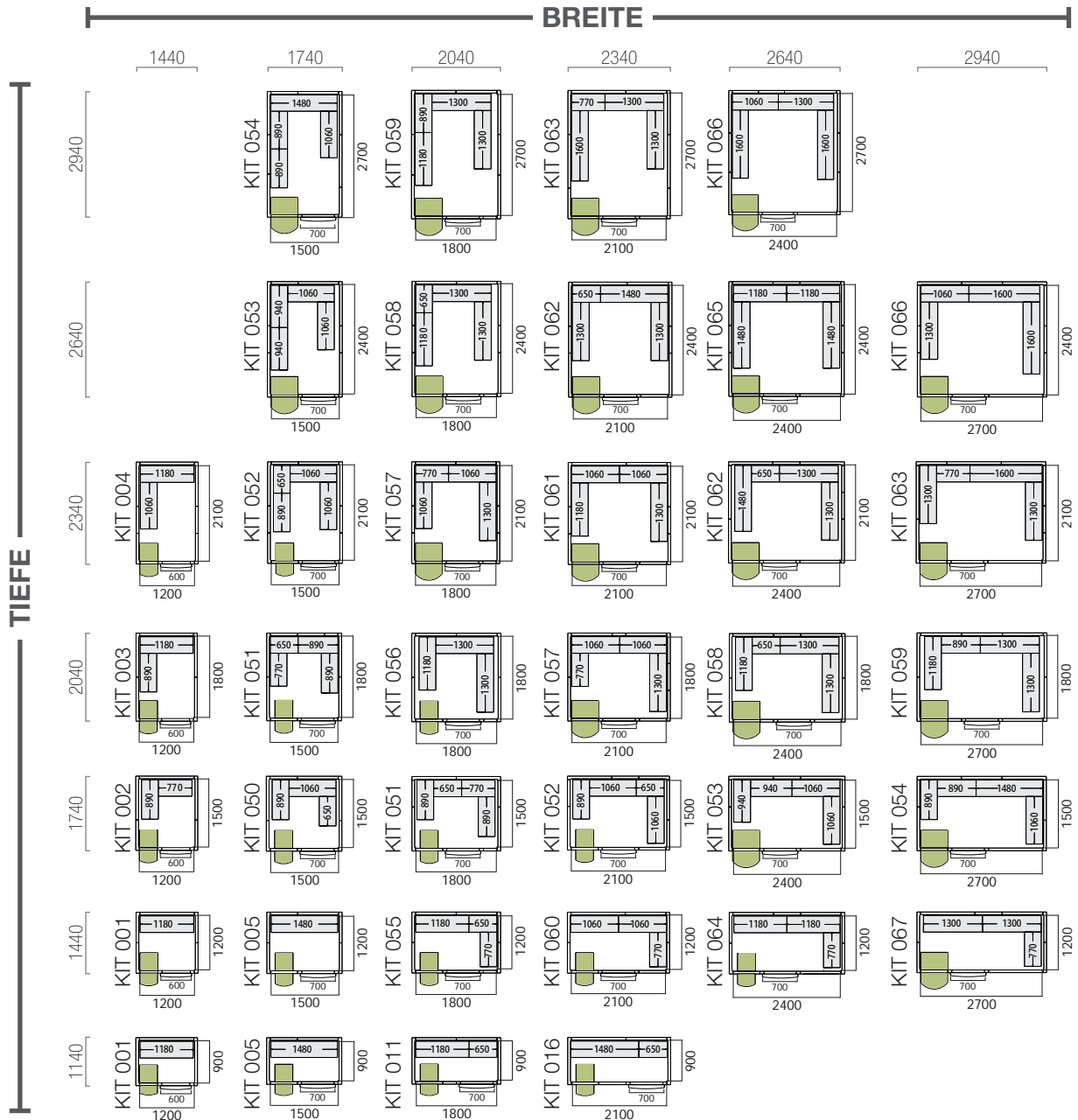

Tiefkühlzellen 100er Wandstärke, 2150er Höhe



Maße/Tür-Seite	Volumen	Regal CODE	Tiefkühlzelle		Tiefkühlaggregat		Komplett EURO
			CODE	€	CODE	EURO	
1440 x 1140 x 2150 mm	2,27	KIT 001	10703201	2.199,00 €	EL 12125b	2.609,00 €	4.808,00
1440 x 1440 x 2150 mm	2,27	KIT 001	10703202	2.549,00 €	EL 12125b	2.609,00 €	5.258,00
1440 x 1740 x 2150 mm	2,27	KIT 002	10703203	2.889,00 €	EL 12125b	2.609,00 €	5.498,00
1440 x 2040 x 2150 mm	2,27	KIT 003	10703204	3.139,00 €	EL 12125b	2.609,00 €	5.748,00
1440 x 2340 x 2150 mm	2,27	KIT 004	10703205	3.499,00 €	EL 12125b	2.609,00 €	6.108,00
1740 x 1140 x 2150 mm	2,27	KIT 005	10703206	2.559,00 €	EL 12125b	2.609,00 €	5.168,00
1740 x 1440 x 2150 mm	2,27	KIT 005	10703207	2.919,00 €	EL 12125b	2.609,00 €	5.528,00
1740 x 1740 x 2150 mm	2,27	KIT 050	10703208	3.279,00 €	EL 12125b	2.609,00 €	5.888,00
1740 x 2040 x 2150 mm	2,27	KIT 051	10703209	3.559,00 €	EL 12125b	2.609,00 €	6.168,00
1740 x 2340 x 2150 mm	2,27	KIT 052	10703210	3.909,00 €	EL 12125b	2.609,00 €	6.518,00
1740 x 2640 x 2150 mm	2,27	KIT 053	10703211	4.189,00 €	EL 17125b	2.649,00 €	6.838,00
1740 x 2940 x 2150 mm	2,27	KIT 054	10703212	4.389,00 €	EL 17125b	2.649,00 €	7.038,00
2040 x 1140 x 2150 mm	2,27	KIT 011	10703213	2.639,00 €	EL 12125b	2.609,00 €	5.248,00
2040 x 1440 x 2150 mm	2,27	KIT 055	10703214	2.939,00 €	EL 12125b	2.609,00 €	5.548,00
2040 x 1740 x 2150 mm	2,27	KIT 051	10703209	3.559,00 €	EL 12125b	2.609,00 €	6.168,00
2040 x 2040 x 2150 mm	2,27	KIT 056	10703215	3.889,00 €	EL 12125b	2.609,00 €	6.498,00
2040 x 2340 x 2150 mm	2,27	KIT 057	10703216	4.299,00 €	EL 17125b	2.649,00 €	6.948,00
2040 x 2640 x 2150 mm	2,27	KIT 058	10703217	4.589,00 €	EL 17125b	2.649,00 €	7.238,00
2040 x 2940 x 2150 mm	2,27	KIT 059	10703218	4.899,00 €	EL 17125b	2.649,00 €	7.548,00
2340 x 1140 x 2150 mm	2,27	KIT 016	10703219	3.079,00 €	EL 12125b	2.609,00 €	5.688,00
2340 x 1440 x 2150 mm	2,27	KIT 060	10703220	3.539,00 €	EL 12125b	2.609,00 €	6.148,00
2340 x 1740 x 2150 mm	2,27	KIT 052	10703210	3.909,00 €	EL 12125b	2.609,00 €	6.518,00
2340 x 2040 x 2150 mm	2,27	KIT 054	10703216	4.299,00 €	EL 17125b	2.649,00 €	6.948,00
2340 x 2340 x 2150 mm	2,27	KIT 061	10703221	4.669,00 €	EL 17125b	2.649,00 €	7.318,00
2340 x 2640 x 2150 mm	2,27	KIT 062	10703222	5.009,00 €	EL 17125b	2.649,00 €	7.658,00
2340 x 2940 x 2150 mm	2,27	KIT 063	10703223	5.519,00 €	EL 19130b	3.709,00 €	9.228,00
2640 x 1440 x 2150 mm	2,27	KIT 064	10703224	3.829,00 €	EL 12125b	2.609,00 €	6.438,00
2640 x 1740 x 2150 mm	2,27	KIT 053	10703211	4.189,00 €	EL 17125b	2.649,00 €	6.838,00
2640 x 2040 x 2150 mm	2,27	KIT 058	10703217	4.589,00 €	EL 17125b	2.649,00 €	7.238,00
2640 x 2340 x 2150 mm	2,27	KIT 062	10703222	5.009,00 €	EL 17125b	2.649,00 €	7.658,00
2640 x 2640 x 2150 mm	2,27	KIT 065	10703225	5.459,00 €	EL 19130b	3.709,00 €	9.168,00
2640 x 2940 x 2150 mm	2,27	KIT 066	10703226	5.889,00 €	EL 19130b	3.709,00 €	9.598,00
2940 x 1440 x 2150 mm	2,27	KIT 067	10706227	4.449,00 €	EL 17125b	2.649,00 €	7.098,00
2940 x 1740 x 2150 mm	2,27	KIT 054	10703212	4.389,00 €	EL 17125b	2.649,00 €	7.038,00
2940 x 2040 x 2150 mm	2,27	KIT 059	10703218	4.899,00 €	EL 17125b	2.649,00 €	7.548,00
2940 x 2340 x 2150 mm	2,27	KIT 063	10703223	5.519,00 €	EL 19130b	3.709,00 €	9.228,00
2940 x 2640 x 2150 mm	2,27	KIT 066	10703226	5.889,00 €	EL 19130b	3.709,00 €	9.598,00



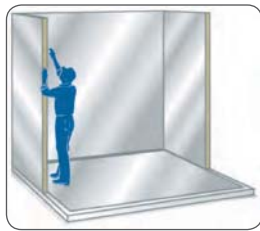







Tiefkühlzellen 100er Wandstärke, 2500er Höhe

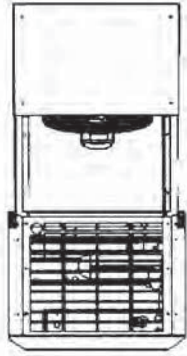

Maße	Volumen m ³	Regal	Tiefkühlzelle		Tiefkühlaggregat		Komplett EURO
			CODE	EURO	CODE	EURO	
1440 x 1440 x 2500	3,54	KIT 001	10706202	2.769,00 €	EL 12125b	2.609,00 €	5.378,00 €
1440 x 2040 x 2500	5,25	KIT 003	10706204	3.409,00 €	EL 12125b	2.609,00 €	6.018,00 €
1440 x 2340 x 2500	6,10	KIT 004	10706205	3.779,00 €	EL 12125b	2.609,00 €	6.388,00 €
1740 x 2040 x 2500	6,52	KIT 051	10706209	3.829,00 €	EL 17125b	2.649,00 €	6.478,01 €
1740 x 2640 x 2500	8,64	KIT 053	10706211	4.509,00 €	EL 17125b	2.649,00 €	7.158,00 €
1740 x 2940 x 2500	9,71	KIT 054	10706212	4.869,00 €	EL 17125b	2.649,00 €	7.518,00 €
2040 x 1140 x 2500	3,98	KIT 011	10706213	3.069,00 €	EL 12125b	2.609,00 €	5.678,00 €
2040 x 1740 x 2500	6,52	KIT 051	10706209	3.829,00 €	EL 17125b	2.649,00 €	6.678,00 €
2040 x 2040 x 2500	7,79	KIT 056	10706215	4.189,00 €	EL 17125b	2.649,00 €	6.838,00 €
2040 x 2340 x 2500	9,06	KIT 057	10706216	4.619,00 €	EL 17125b	2.649,00 €	7.268,00 €
2040 x 2940 x 2500	11,60	KIT 059	10706218	5.259,00 €	EL 19130b	3.709,00 €	8.968,00 €
2340 x 1140 x 2500	4,63	KIT 016	10706219	3.329,00 €	EL 12125b	2.609,00 €	5.938,00 €
2340 x 2040 x 2500	9,06	KIT 054	10706216	4.619,00 €	EL 17125b	2.649,00 €	7.268,00 €
2340 x 2940 x 2500	13,49	KIT 063	10706223	5.909,00 €	EL 19130b	3.709,00 €	9.618,00 €
2640 x 1440 x 2500	6,96	KIT 064	10706224	4.129,00 €	EL 17125b	2.649,00 €	6.778,00 €
2640 x 1740 x 2500	8,64	KIT 053	10706211	4.509,00 €	EL 17125b	2.649,00 €	7.158,00 €
2640 x 2040 x 2500	10,33	KIT 058	10706216	4.619,00 €	EL 17125b	2.649,00 €	7.268,00 €
2940 x 1740 x 2500	9,71	KIT 054	10706212	4.929,00 €	EL 17125b	2.649,00 €	7.578,00 €
2940 x 2040 x 2500	11,60	KIT 059	10706218	5.259,00 €	EL 19130b	3.709,00 €	8.978,00 €
2940 x 2340 x 2500	13,49	KIT 063	10706223	5.909,00 €	EL 19130b	3.709,00 €	9.638,00 €
2940 x 2640 x 2500	15,38	KIT 066	10706226	6.289,00 €	EL 24225b	4.179,00 €	10.438,00 €

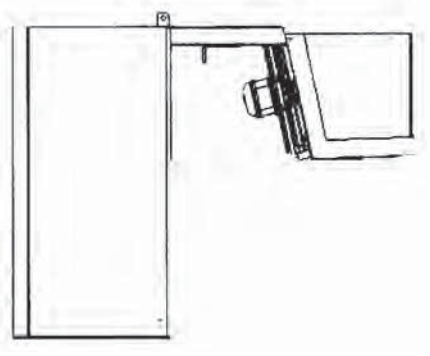

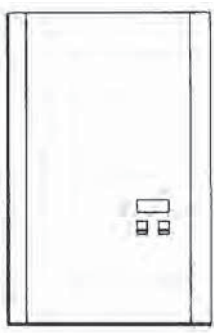













Kühlaggregat Monoblock





















	Artikel			Code	Euro	
	Kühlaggregat · 321 x 617 x 738 mm · 0,6 kW, 230 V, 50 Hz, · Kompressortyp E			EL 04123N	1.879,00	
	Volumen	4,63 m ³	4,73 m ³			5,11 m ³
	Außen	32°C	32°C			32°C
	Innen	-2°C	0°C			+5°C
						
	Kühlaggregat · 450 x 700 x 890 mm · 0,7 kW, 230 V, 50 Hz, · Kompressortyp E			EL 06125N	2.119,00	
	Volumen	6,82 m ³	7,10 m ³			7,67 m ³
	Außen	32°C	32°C			32°C
	Innen	-2°C	0°C			+5°C
						
	Kühlaggregat · 450 x 700 x 890 mm · 0,9 kW, 230 V, 50 Hz, · Kompressortyp E			EL 07125N	2.249,00	
	Volumen	10,45 m ³	10,88 m ³			11,76 m ³
	Außen	32°C	32°C			32°C
	Innen	-2°C	0°C			+5°C
						
	Kühlaggregat · 450 x 700 x 890 mm · 1 kW, 230 V, 50 Hz, · Kompressortyp E			EL 09125N	2.329,00	
	Volumen	13,63 m ³	14,19 m ³			15,33 m ³
	Außen	32°C	32°C			32°C
	Innen	-2°C	0°C			+5°C
						
	Kühlaggregat · 1147 x 830 x 886 mm · 219 W, 400 V, 3 P, 50 Hz · Kompressortyp E			EL 24325N	4.019,00	
	Volumen	61,05 m ³	66,36 m ³			71,67 m ³
	Außen	32°C	32°C			32°C
	Innen	-2°C	0°C			+5°C
						

Splitting Aggregat normale Kühlung



	Artikel			Code	Euro	
 <p>1008 x 513 x 207 mm Größe des Verdampfers</p>	Splitting Aggregat · 740 x 440 x 410 mm · 1,15 kW, 230 V, 50 Hz, · Kompressortyp E · Verpackungsmaß: 800 x 600 x 875 mm			Iceberg 06125N	2.629,00	
	Volumen	7,18 m ³	7,80 m ³			8,43 m ³
	Außen	32°C	32°C			32°C
	Innen	-5°C	0°C			+5°C
	 1150 W	 230 V / 50 Hz	 53	 73		
 <p>1008 x 513 x 207 mm Größe des Verdampfers</p>	Splitting Aggregat · 740 x 440 x 410 mm · 1,5 kW, 230 V, 50 Hz, · Kompressortyp E · Verpackungsmaß: 1260 x 600 x 875 mm			Iceberg 07125N	3.039,00	
	Volumen	9 m ³	10 m ³			11 m ³
	Außen	32°C	32°C			32°C
	Innen	-5°C	0°C			+5°C
	 1500 W	 230 V / 50 Hz	 62	 89		
 <p>1008 x 513 x 207 mm Größe des Verdampfers</p>	Splitting Aggregat · 740 x 440 x 410 mm · 1,6 kW, 230 V, 50 Hz, · Kompressortyp E · Verpackungsmaß: 1260 x 600 x 875 mm			Iceberg 09125N	3.189,00	
	Volumen	12 m ³	13 m ³			14 m ³
	Außen	32°C	32°C			32°C
	Innen	-5°C	0°C			+5°C
	 1600 W	 230 V / 50 Hz	 64	 91		

Deckenaggregat normale Kühlung





	Artikel			Code	Euro	
	Deckenaggregat · 901 x 436 x 486 mm · 0,6 kW, 230 V, 50 Hz, · Kompressortyp E · Verpackungsmaß: 940 x 530 x 550 mm			KUMA04123N	2.269,00	
	Volumen	3,64 m ³	3,79 m ³			4,09 m ³
	Außen	32°C	32°C			32°C
	Innen	-2°C	0°C			+5°C
	 600 W  230 V / 50 Hz  kg/net 59  kg/br 85					
	Deckenaggregat · 901 x 436 x 486 mm · 0,7 kW, 230 V, 50 Hz, · Kompressortyp E · Verpackungsmaß: 940 x 530 x 550 mm			KUMA06123N	2.369,00	
	Volumen	5,91 m ³	6,15 m ³			6,65 m ³
	Außen	32°C	32°C			32°C
	Innen	-2°C	0°C			+5°C
	 700 W  230 V / 50 Hz  kg/net 60  kg/br 90					
	Deckenaggregat · 1054 x 514 x 554 mm · 0,9 kW, 230 V, 50 Hz, · Kompressortyp E · Verpackungsmaß: 1090 x 600 x 610 mm			KUMA07125N	2.529,00	
	Volumen	9,55 m ³	9,94 m ³			10,73 m ³
	Außen	32°C	32°C			32°C
	Innen	-2°C	0°C			+5°C
	 900 W  230 V / 50 Hz  kg/net 67  kg/br 97					
	Deckenaggregat · 1054 x 514 x 554 mm · 1 kW, 230 V, 50 Hz, · Kompressortyp E · Verpackungsmaß: 1090 x 600 x 610 mm			KUMA09125N	2.719,00	
	Volumen	12,73 m ³	13,25 m ³			14,31 m ³
	Außen	32°C	32°C			32°C
	Innen	-2°C	0°C			+5°C
	 1000 W  230 V / 50 Hz  kg/net 68  kg/br 98					

Deckenaggregat Tiefkühlung



	Artikel			Code	Euro	
	Tiefkühl-Deckenaggregat · 1055 x 514 x 560 mm · 230 V, 50 Hz, 1 kW · Kompressortyp E · Verpackungsmaß: 1090 x 600 x 610 mm			KUMA12125B	2.869,00	
	Volumen	5,17 m ³	6,15 m ³			7,14 m ³
	Außen	32°C	32°C			32°C
	Innen	-25°C	-20°C			-15°C
	1000 W 230 V / 50 Hz kg /net 63 kg /br 93					
	Tiefkühl-Deckenaggregat · 1055 x 514 x 560 mm · 230 V, 50 Hz, 1,3 kW · Kompressortyp E · Verpackungsmaß: 1090 x 600 x 610 mm			KUMA17125B	3.199,00	
	Volumen	8,35 m ³	9,94 m ³			11,53 m ³
	Außen	32°C	32°C			32°C
	Innen	-25°C	-20°C			-15°C
	1300 W 230 V / 50 Hz kg /net 70 kg /br 100					

Tiefkühlaggregat Monoblock

	Artikel			Code	Euro		
	Tiefkühlaggregat · 450 x 885 x 700 mm · 1,0 kW, 230 V, 50 Hz, · Kompressortyp E			EL12125B	2.609,00		
	Volumen	5,17 m ³	6,15 m ³			7,14 m ³	
	Außen	32°C	32°C			32°C	
	Innen	-25°C	-20°C			-15°C	
	Volumen	4,39 m ³	5,40 m ³			6,49 m ³	
	Außen	43°C	43°C			43°C	
	Innen	-25°C	-20°C			-15°C	
							
	Tiefkühlaggregat · 450 x 885 x 700 mm · 1,3 kW, 230 V, 50 Hz, · Kompressortyp E					EL17125B	2.649,00
	Volumen	8,35 m ³	9,94 m ³				
Außen	32°C	32°C	32°C				
Innen	-25°C	-20°C	-15°C				
Volumen	7,09 m ³	8,72 m ³	10,44 m ³				
Außen	43°C	43°C	43°C				
Innen	-25°C	-20°C	-15°C				
							
Tiefkühlaggregat · 644 x 914 x 830 mm · 2,0 kW, 230 V, 50 Hz, · Kompressortyp E			EL19130B	3.709,00			
Volumen	11,93 m ³	14,19 m ³			16,47 m ³		
Außen	32°C	32°C			32°C		
Innen	-25°C	-20°C			-15°C		
Volumen	10,12 m ³	12,46 m ³			15,03 m ³		
Außen	43°C	43°C			43°C		
Innen	-25°C	-20°C			-15°C		
							
Tiefkühlaggregat · 1147 x 830 x 886 mm · 219 W, 400 V, 3 P, 50 Hz, · Kompressortyp E					EL35325B	5.839,00	
Volumen	34,09 m ³	41,96 m ³					50,61 m ³
Außen	32°C	32°C	32°C				
Innen	-25°C	-20°C	-15°C				
Volumen	29,02 m ³	35,72 m ³	43,08 m ³				
Außen	43°C	43°C	43°C				
Innen	-25°C	-20°C	-15°C				
							

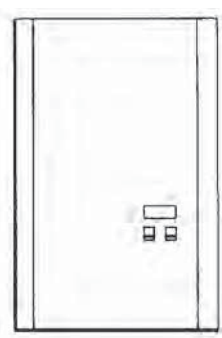
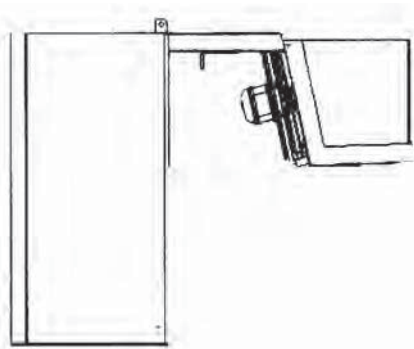
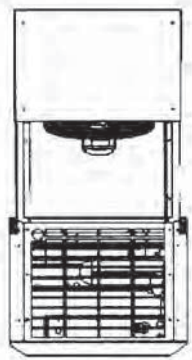

Splitting Aggregat Tiefkühlung

Top - Professional



Iceberg

ist ein professionelles Splitting-Aggregat.
Es ist Innen wie Außen einsetzbar – sogar bei Regen!
Egal ob im Sommer oder im Winter – es gibt keine Probleme!

- lackierter Verdampfer mit thermostatischem Ventil
- Fassung für Lichtquelle in der Zelle vorhanden
- Funktionsweise mit Thermostat-Wert

- Kondensationskontrolle
- Heizkabel im Kompressor vorhanden
- Kontakt für Türrahmenheizung
- Kontakt für Türschalter
- Niederdruckpressostat (auf 200°C gebrannt)
- Karosserie verzinkt, pulverbeschichtet
- Hochdruckpressostat
- werden ohne Kälteleitungen geliefert

	Artikel			Code	Euro	
<p>1008 x 513 x 207 mm Größe des Verdampfers</p>	Tiefkühl-Splitting Aggregat · 740 x 440 x 410 mm · 1,2 kW, 230 V, 50 Hz, · Kompressortyp E · Verpackungsmaß: 1260 x 600 x 875 mm			Iceberg 12125B	3.129,00	
	Volumen	6,28 m ³	6,83 m ³			7,37 m ³
	Außen	32°C	32°C			32°C
	Innen	-22°C	-20°C			-18°C
	1200 W 230 V / 50 Hz kg/net 67 kg/lbr 94					
<p>1008 x 513 x 207 mm Größe des Verdampfers</p>	Tiefkühl-Splitting Aggregat · 740 x 440 x 410 mm · 1,5 kW, 230 V, 50 Hz, · Kompressortyp E · Verpackungsmaß: 1260 x 600 x 875 mm			Iceberg 17125B	3.229,00	
	Volumen	10 m ³	11 m ³			12 m ³
	Außen	32°C	32°C			32°C
	Innen	-22°C	-20°C			-18°C
	1500 W 230 V / 50 Hz kg/net 68 kg/lbr 95					

Regale



	Artikel	Code	Euro
	<p>Regal 500 mm tief</p> <ul style="list-style-type: none"> · 1200 x 500 x 1550 mm · Edelstahl, 4 Ablageböden · Ablageboden 1200 x 500 mm · Maß zwischen den Böden 420 mm · Traglast ca. 320 kg 	GG1001	399,00
			
	<p>Regale</p> <ul style="list-style-type: none"> · 4 Böden, Selbstmontage, aus CS · Traglast max. 150 kg je Boden · Abstand zwischen den Böden 565 mm · Abstand vom Boden zum Regalboden 100 mm · Regalständer-Überstand oben 55 mm · Regalböden sind nicht höhenverstellbar 		
	<ul style="list-style-type: none"> · 1000 x 480 x 2000 mm · 1200 x 480 x 2000 mm · 1400 x 480 x 2000 mm · 1600 x 480 x 2000 mm · 1800 x 480 x 2000 mm · 2000 x 480 x 2000 mm 	<p>RR3027</p> <p>RR3029</p> <p>RR3031</p> <p>RR3033</p> <p>RR3035</p> <p>RR3037</p>	<p>399,00</p> <p>369,00</p> <p>419,00</p> <p>449,00</p> <p>479,00</p> <p>499,00</p>

Regalsystem für Kühlzellen

Maße	Tiefe x Höhe	Böden	Code	kg	Euro
1180	370 x 1670 mm	4	KIT 001	16	359,00 €
890 + 770	370 x 1670 mm	4	KIT 002	20	599,00 €
1180 + 890	370 x 1670 mm	4	KIT 003	24	649,00 €
1180 + 1060	370 x 1670 mm	4	KIT 004	26	679,00 €
1480	370 x 1670 mm	4	KIT 005	19	399,00 €
1180 + 650	370 x 1670 mm	4	KIT 011	22	629,00 €
1480 + 650	370 x 1670 mm	4	KIT 016	25	669,00 €
650 + 940	370 x 1670 mm	4	KIT 18	25	499,00 €
650 + 1180	370 x 1670 mm	4	KIT 26	29	539,00 €
650 + 1480	370 x 1670 mm	4	KIT 31	30	569,00 €
940 + 1480	370 x 1670 mm	4	KIT 37	32	599,00 €
940 + 1180	370 x 1670 mm	4	KIT 35	30	569,00 €
1300 + 1180	370 x 1670 mm	4	KIT 40	32	599,00 €
940 + 890 + 940	370 x 1670 mm	4	KIT 43	40	739,00 €
1300 + 1480	370 x 1670 mm	4	KIT 48	40	649,00 €
1600 + 1180	370 x 1670 mm	4	KIT 50	42	619,00 €
1060 + 890 + 650	370 x 1670 mm	4	KIT 050	29	939,00 €
890 + 770 + 650 + 890	370 x 1670 mm	4	KIT 051	34	1.139,00 €
1060 + 890 + 650 + 1060	370 x 1670 mm	4	KIT 052	39	1.219,00 €
1060 + 940 + 1060 + 940	370 x 1670 mm	4	KIT 053	42	1.289,00 €
1480 + 890 + 890 + 1060	370 x 1670 mm	4	KIT 054	45	1.319,00 €
1180 + 890 + 940	370 x 1670 mm	4	KIT 55	42	779,00 €
1180 + 650 + 770	370 x 1670 mm	4	KIT 055	29	889,00 €
1180 + 1300 + 1300	370 x 1670 mm	4	KIT 056	40	1.119,00 €
1060 + 1060 + 770 + 1300	370 x 1670 mm	4	KIT 057	43	1.299,00 €
1180 + 650 + 1300 + 1300	370 x 1670 mm	4	KIT 058	43	1.329,00 €
1600 + 1480	370 x 1670 mm	4	KIT 59	42	689,00 €
1300 + 1180 + 890 + 1300	370 x 1670 mm	4	KIT 059	48	689,00 €
1060 + 770 + 1060	370 x 1670 mm	4	KIT 060	32	1.359,00 €
1300 + 1180 + 1060 + 1060	370 x 1670 mm	4	KIT 061	47	939,00 €
1300 + 1480 + 1300 + 650	370 x 1670 mm	4	KIT 062	48	1.369,00 €
1300 + 1600 + 1300 + 770	370 x 1670 mm	4	KIT 063	63	1.379,00 €
1180 + 1180 + 770	370 x 1670 mm	4	KIT 064	34	1.399,00 €
1180 + 1480 + 1180 + 1480	370 x 1670 mm	4	KIT 065	54	969,00 €
1600 + 1060 + 1300 + 1600	370 x 1670 mm	4	KIT 066	56	1.479,00 €
1600 + 890 + 940	370 x 1670 mm	4	KIT 67	45	1.499,00 €
1300 + 1300 + 770	370 x 1670 mm	4	KIT 067	36	819,00 €
1480 + 1060 + 1060	370 x 1670 mm	4	KIT 80	47	999,00 €
940 + 940 + 1060 + 1060	370 x 1670 mm	4	KIT 90	50	859,00 €
940 + 940 + 1480 + 1300	370 x 1670 mm	4	KIT 116	60	989,00 €

Grundregal- und Anbauregalsysteme



Für eine optimale Organisation

- Platzsparend
- leichter & schneller Aufbau
- Kunststoffböden höhenverstellbar & herausnehmbar
- sehr pflegeleicht
- geringes Gewicht

**Kombinieren
Sie verschiedene
Tiefen & Höhen
miteinander!**



Lagerregale	Höhe	Tiefe	Regalart	Seite
	1670 mm	370 mm	Grundregal	172
	1670 mm	370 mm	Anbauregal	173
	2000 mm	370 mm	Grundregal	174
	2000 mm	370 mm	Anbauregal	175
	1670 mm	470 mm	Grundregal	176
	1670 mm	470 mm	Anbauregal	177
	2000 mm	470 mm	Grundregal	178
	2000 mm	470 mm	Anbauregal	179
	1750 mm	385 mm	Grundregal 2/3 GN	180
	1750 mm	385 mm	Anbauregal 2/3 GN	181
	2000 mm	385 mm	Grundregal 2/3 GN	182
	2000 mm	385 mm	Anbauregal 2/3 GN	183
	1750 mm	560 mm	Grundregal 1/1 GN	184
	1750 mm	560 mm	Anbauregal 1/1 GN	185
	2000 mm	560 mm	Grundregal 1/1 GN	186
	2000 mm	560 mm	Anbauregal 1/1 GN	187

Höhe: **1670 mm**
Tiefe: **370 mm**

Grundregalsystem / Kühlzelle & Lager



- Platzsparend
- leichter & schneller Aufbau
- Kunststoffböden höhenverstellbar & herausnehmbar
- sehr pflegeleicht
- geringes Gewicht

Höhe: **1670 mm** | Tiefe: **370 mm**

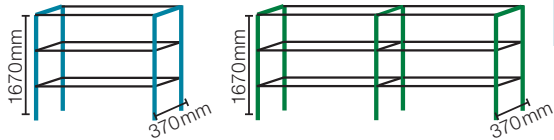

Traglast (Boden):
 < 1 m = **120 kg**
 > 1 m = **100 kg**

ab 1660 mm Breite **DREI** Regalträger

SET	Breite	Innen	3 Böden		4 Böden		5 Böden	
			Code	Euro	Code	Euro	Code	Euro
	650	650	GR13301	249,00	GR13401	279,00	GR13501	319,00
	770	770	GR13302	259,00	GR13402	299,00	GR13502	329,00
	890	890	GR13303	269,00	GR13403	299,00	GR13503	349,00
	940	940	GR13304	279,00	GR13404	329,00	GR13504	369,00
	1060	1060	GR13305	299,00	GR13405	349,00	GR13505	399,00
	1180	1180	GR13306	299,00	GR13406	359,00	GR13506	419,00
	1300	1300	GR13307	319,00	GR13407	369,00	GR13507	429,00
	1480	1480	GR13308	339,00	GR13408	399,00	GR13508	469,00
	1600	1600	GR13309	359,00	GR13409	419,00	GR13509	489,00
	1660	1632	GR13310	449,00	GR13410	529,00	GR13510	599,00
	1710	1682	GR13311	469,00	GR13411	549,00	GR13511	629,00
	1780	1752	GR13312	459,00	GR13412	539,00	GR13512	619,00
	1830	1802	GR13313	479,00	GR13413	559,00	GR13513	649,00
	1880	1852	GR13314	489,00	GR13414	589,00	GR13514	679,00
	1950	1922	GR13315	489,00	GR13415	579,00	GR13515	669,00
	2000	1972	GR13316	499,00	GR13416	599,00	GR13516	699,00
	2070	2042	GR13317	499,00	GR13417	589,00	GR13517	689,00
	2120	2092	GR13318	519,00	GR13418	619,00	GR13518	719,00
	2190	2162	GR13319	519,00	GR13419	599,00	GR13519	699,00
	2240	2212	GR13320	529,00	GR13420	629,00	GR13520	729,00
	2360	2332	GR13321	539,00	GR13421	639,00	GR13521	749,00
	2420	2392	GR13322	549,00	GR13422	659,00	GR13522	769,00
	2480	2452	GR13323	549,00	GR13423	659,00	GR13523	769,00

Höhe: **1670 mm**
Tiefe: **370 mm**

Anbauregalsystem / Kühlzelle & Lager



- Platzsparend
- leichter & schneller Aufbau
- Kunststoffböden höhenverstellbar & herausnehmbar
- sehr pflegeleicht
- geringes Gewicht
- im 90°-Winkel über Eck

L-Form | Höhe: 1670 mm | Tiefe: 370 mm

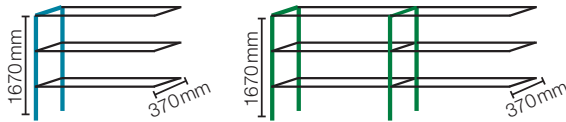

ab 1660 mm Breite Zwei Regalträger

SET	Breite	Innen	3 Böden		4 Böden		5 Böden	
			Code	Euro	Code	Euro	Code	Euro
	650	650	AR13301	199,00 €	AR13401	249,00	AR13501	289,00
	770	770	AR13302	219,00 €	AR13402	266,00	AR13502	319,00
	890	890	AR13303	229,00 €	AR13403	279,00	AR13503	329,00
	940	940	AR13304	239,00 €	AR13404	299,00	AR13504	349,00
	1060	1060	AR13305	249,00 €	AR13405	319,00	AR13505	379,00
	1180	1180	AR13306	259,00 €	AR13406	329,00	AR13506	389,00
	1300	1300	AR13307	279,00 €	AR13407	339,00	AR13507	419,00
	1480	1480	AR13308	299,00 €	AR13408	379,00	AR13508	449,00
	1600	1600	AR13309	319,00 €	AR13409	389,00	AR13509	469,00
	1660	1632	AR13310	419,00 €	AR13410	499,00	AR13510	489,00
	1710	1682	AR13311	429,00 €	AR13411	519,00	AR13511	619,00
	1780	1752	AR13312	419,00 €	AR13412	519,00	AR13512	599,00
	1830	1802	AR13313	439,00 €	AR13413	529,00	AR13513	629,00
	1880	1852	AR13314	449,00 €	AR13414	549,00	AR13514	659,00
	1950	1922	AR13315	449,00 €	AR13415	549,00	AR13515	649,00
	2000	1972	AR13316	469,00 €	AR13416	569,00	AR13516	679,00
	2070	2042	AR13317	459,00 €	AR13417	559,00	AR13517	669,00
	2120	2092	AR13318	479,00 €	AR13418	589,00	AR13518	699,00
	2190	2162	AR13319	469,00 €	AR13419	579,00	AR13519	689,00
	2240	2212	AR13320	489,00 €	AR13420	599,00	AR13520	719,00
	2360	2332	AR13321	499,00 €	AR13421	619,00	AR13521	729,00
	2420	2392	AR13322	519,00 €	AR13422	629,00	AR13522	749,00
	2480	2452	AR13323	499,00 €	AR13423	629,00	AR13523	749,00

Höhe: **2000 mm**
Tiefe: **370 mm**

Grundregalsystem / Kühlzelle & Lager



- Platzsparend
- leichter & schneller Aufbau
- Kunststoffböden höhenverstellbar & herausnehmbar
- sehr pflegeleicht
- geringes Gewicht

Höhe: 2000 mm | Tiefe: 370 mm

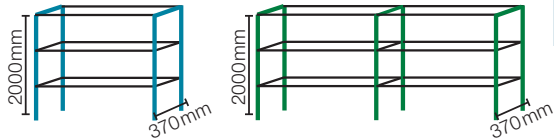

Traglast (Boden):
 < 1 m = **120 kg**
 > 1 m = **100 kg**

ab 1660 mm Breite **DREI** Regalträger

Breite	Außen	Innen	3 Böden		4 Böden		5 Böden	
			Code	Euro	Code	Euro	Code	Euro
650	650	650	GR23301	269,00	GR23401	299,00	GR23501	339,00
770	770	770	GR23302	289,00	GR23402	319,00	GR23502	359,00
890	890	890	GR23303	299,00	GR23403	339,00	GR23503	379,00
940	940	940	GR23304	319,00	GR23404	359,00	GR23504	399,00
1060	1060	1060	GR23305	319,00	GR23405	369,00	GR23505	419,00
1180	1180	1180	GR23306	329,00	GR23406	389,00	GR23506	439,00
1300	1300	1300	GR23307	349,00	GR23407	399,00	GR23507	459,00
1480	1480	1480	GR23308	369,00	GR23408	429,00	GR23508	499,00
1600	1600	1600	GR23309	379,00	GR23409	449,00	GR23509	519,00
1660	1660	1632	GR23310	489,00	GR23410	569,00	GR23510	649,00
1710	1710	1682	GR23311	499,00	GR23411	589,00	GR23511	659,00
1780	1780	1752	GR23312	499,00	GR23412	579,00	GR23512	659,00
1830	1830	1802	GR23313	519,00	GR23413	599,00	GR23513	689,00
1880	1880	1852	GR23314	529,00	GR23414	629,00	GR23514	719,00
1950	1950	1922	GR23315	529,00	GR23415	619,00	GR23515	719,00
2000	2000	1972	GR23316	549,00	GR23416	639,00	GR23516	739,00
2070	2070	2042	GR23317	539,00	GR23417	629,00	GR23517	729,00
2120	2120	2092	GR23318	559,00	GR23418	659,00	GR23518	759,00
2190	2190	2162	GR23319	549,00	GR23419	649,00	GR23519	749,00
2240	2240	2212	GR23320	569,00	GR23420	669,00	GR23520	769,00
2360	2360	2332	GR23321	579,00	GR23421	679,00	GR23521	789,00
2420	2420	2392	GR23322	589,00	GR23422	699,00	GR23522	819,00
2480	2480	2452	GR23323	589,00	GR23423	699,00	GR23523	799,00

Höhe: **2000 mm**
Tiefe: **370 mm**

Anbauregalsystem / Kühlzelle & Lager



- Platzsparend
- leichter & schneller Aufbau
- Kunststoffböden höhenverstellbar & herausnehmbar
- sehr pflegeleicht
- geringes Gewicht
- im 90°-Winkel über Eck

L-Form | Höhe: 2000 mm | Tiefe: 370 mm

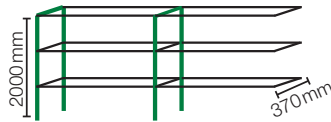
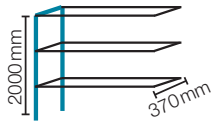
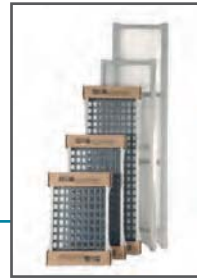

ab 1660 mm Breite Zwei Regalträger

Breite	Außen	Innen	3 Böden		4 Böden		5 Böden	
			Code	Euro	Code	Euro	Code	Euro
650	650	650	AR23301	219,00	AR23401	259,00	AR23501	299,00
770	770	770	AR23302	229,00	AR23402	279,00	AR23502	329,00
890	890	890	AR23303	239,00	AR23403	289,00	AR23503	339,00
940	940	940	AR23304	259,00	AR23404	319,00	AR23504	369,00
1060	1060	1060	AR23305	269,00	AR23405	329,00	AR23505	389,00
1180	1180	1180	AR23306	279,00	AR23406	339,00	AR23506	399,00
1300	1300	1300	AR23307	289,00	AR23407	359,00	AR23507	419,00
1480	1480	1480	AR23308	319,00	AR23408	389,00	AR23508	469,00
1600	1600	1600	AR23309	329,00	AR23409	399,00	AR23509	489,00
1660	1660	1632	AR23310	439,00	AR23410	529,00	AR23510	619,00
1710	1710	1682	AR23311	449,00	AR23411	549,00	AR23511	639,00
1780	1780	1752	AR23312	449,00	AR23412	539,00	AR23512	629,00
1830	1830	1802	AR23313	459,00	AR23413	559,00	AR23513	659,00
1880	1880	1852	AR23314	479,00	AR23414	579,00	AR23514	679,00
1950	1950	1922	AR23315	479,00	AR23415	579,00	AR23515	679,00
2000	2000	1972	AR23316	489,00	AR23416	599,00	AR23516	699,00
2070	2070	2042	AR23317	489,00	AR23417	589,00	AR23517	689,00
2120	2120	2092	AR23318	499,00	AR23418	619,00	AR23518	719,00
2190	2190	2162	AR23319	499,00	AR23419	599,00	AR23519	719,00
2240	2240	2212	AR23320	519,00	AR23420	629,00	AR23520	739,00
2360	2360	2332	AR23321	519,00	AR23421	639,00	AR23521	749,00
2420	2420	2392	AR23322	539,00	AR23422	659,00	AR23522	779,00
2480	2480	2452	AR23323	539,00	AR23423	659,00	AR23523	779,00

Höhe: **1670 mm**
Tiefe: **470 mm**

Grundregalsystem / Kühlzelle & Lager



- Platzsparend
- leichter & schneller Aufbau
- Kunststoffböden höhenverstellbar & herausnehmbar
- sehr pflegeleicht
- geringes Gewicht

Höhe: **1670 mm** | Tiefe: **470 mm**

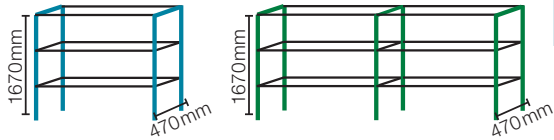

Traglast (Boden):
 < 1 m = **120 kg**
 > 1 m = **100 kg**

ab 1660 mm Breite **DREI** Regalträger

Breite	Außen	Innen	3 Böden		4 Böden		5 Böden	
			Code	Euro	Code	Euro	Code	Euro
650	650	650	GR14301	259,00	GR14401	299,00	GR14501	339,00
770	770	770	GR14302	279,00	GR14402	319,00	GR14502	359,00
890	890	890	GR14303	289,00	GR14403	329,00	GR14503	379,00
940	940	940	GR14304	299,00	GR14404	359,00	GR14504	399,00
1060	1060	1060	GR14305	319,00	GR14405	369,00	GR14505	429,00
1180	1180	1180	GR14306	329,00	GR14406	389,00	GR14506	449,00
1300	1300	1300	GR14307	349,00	GR14407	419,00	GR14507	479,00
1480	1480	1480	GR14308	369,00	GR14408	439,00	GR14508	519,00
1600	1600	1600	GR14309	379,00	GR14409	459,00	GR14509	539,00
1660	1660	1632	GR14310	489,00	GR14410	569,00	GR14510	659,00
1710	1710	1682	GR14311	499,00	GR14411	599,00	GR14511	689,00
1780	1780	1752	GR14312	499,00	GR14412	589,00	GR14512	679,00
1830	1830	1802	GR14313	519,00	GR14413	619,00	GR14513	719,00
1880	1880	1852	GR14314	539,00	GR14414	639,00	GR14514	739,00
1950	1950	1922	GR14315	529,00	GR14415	629,00	GR14515	729,00
2000	2000	1972	GR14316	549,00	GR14416	659,00	GR14516	759,00
2070	2070	2042	GR14317	539,00	GR14417	649,00	GR14517	749,00
2120	2120	2092	GR14318	559,00	GR14418	669,00	GR14518	779,00
2190	2190	2162	GR14319	559,00	GR14419	669,00	GR14519	769,00
2240	2240	2212	GR14320	569,00	GR14420	689,00	GR14520	799,00
2360	2360	2332	GR14321	589,00	GR14421	699,00	GR14521	829,00
2420	2420	2392	GR14322	599,00	GR14422	729,00	GR14522	849,00
2480	2480	2452	GR14323	599,00	GR14423	729,00	GR14523	849,00

Höhe: **1670 mm**
Tiefe: **470 mm**

Anbauregalsystem / Kühlzelle & Lager



- Platzsparend
- leichter & schneller Aufbau
- Kunststoffböden höhenverstellbar & herausnehmbar
- sehr pflegeleicht
- geringes Gewicht
- im 90°-Winkel über Eck

L-Form | Höhe: 1670 mm | Tiefe: 470 mm

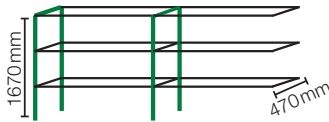
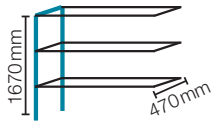
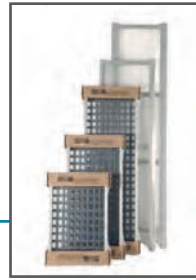

ab 1660 mm Breite Zwei Regalträger

Breite	Außen	Innen	3 Böden		4 Böden		5 Böden	
			Code	Euro	Code	Euro	Code	Euro
650	650	650	AR14301	229,00	AR14401	279,00	AR14501	329,00
770	770	770	AR14302	239,00	AR14402	289,00	AR14502	349,00
890	890	890	AR14303	249,00	AR14403	299,00	AR14503	369,00
940	940	940	AR14304	269,00	AR14404	329,00	AR14504	399,00
1060	1060	1060	AR14305	279,00	AR14405	349,00	AR14505	419,00
1180	1180	1180	AR14306	289,00	AR14406	369,00	AR14506	439,00
1300	1300	1300	AR14307	299,00	AR14407	389,00	AR14507	469,00
1480	1480	1480	AR14308	329,00	AR14408	419,00	AR14508	499,00
1600	1600	1600	AR14309	349,00	AR14409	439,00	AR14509	529,00
1660	1660	1632	AR14310	449,00	AR14410	549,00	AR14510	649,00
1710	1710	1682	AR14311	469,00	AR14411	569,00	AR14511	679,00
1780	1780	1752	AR14312	459,00	AR14412	569,00	AR14512	669,00
1830	1830	1802	AR14313	479,00	AR14413	589,00	AR14513	699,00
1880	1880	1852	AR14314	499,00	AR14414	619,00	AR14514	729,00
1950	1950	1922	AR14315	489,00	AR14415	599,00	AR14515	719,00
2000	2000	1972	AR14316	519,00	AR14416	629,00	AR14516	749,00
2070	2070	2042	AR14317	499,00	AR14417	619,00	AR14517	739,00
2120	2120	2092	AR14318	519,00	AR14418	649,00	AR14518	769,00
2190	2190	2162	AR14319	519,00	AR14419	639,00	AR14519	769,00
2240	2240	2212	AR14320	539,00	AR14420	669,00	AR14520	789,00
2360	2360	2332	AR14321	549,00	AR14421	679,00	AR14521	819,00
2420	2420	2392	AR14322	559,00	AR14422	699,00	AR14522	839,00
2480	2480	2452	AR14323	559,00	AR14423	699,00	AR14523	839,00

Höhe: **2000 mm**
Tiefe: **470 mm**

Grundregalsystem / Kühlzelle & Lager



- Platzsparend
- leichter & schneller Aufbau
- Kunststoffböden höhenverstellbar & herausnehmbar
- sehr pflegeleicht
- geringes Gewicht

Höhe: 2000 mm | Tiefe: 470 mm

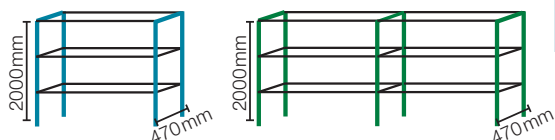

Traglast (Boden):
 < 1 m = **120 kg**
 > 1 m = **100 kg**

ab 1660 mm Breite **DREI** Regalträger

Breite	Außen	Innen	3 Böden		4 Böden		5 Böden	
			Code	Euro	Code	Euro	Code	Euro
650	650	650	GR24301	289,00	GR24401	329,00	GR24501	369,00
770	770	770	GR24302	299,00	GR24402	349,00	GR24502	389,00
890	890	890	GR24303	319,00	GR24403	359,00	GR24503	399,00
940	940	940	GR24304	339,00	GR24404	389,00	GR24504	439,00
1060	1060	1060	GR24305	349,00	GR24405	399,00	GR24505	459,00
1180	1180	1180	GR24306	359,00	GR24406	419,00	GR24506	479,00
1300	1300	1300	GR24307	379,00	GR24407	439,00	GR24507	499,00
1480	1480	1480	GR24308	399,00	GR24408	479,00	GR24508	549,00
1600	1600	1600	GR24309	419,00	GR24409	489,00	GR24509	569,00
1660	1660	1632	GR24310	529,00	GR24410	619,00	GR24510	699,00
1710	1710	1682	GR24311	549,00	GR24411	649,00	GR24511	739,00
1780	1780	1752	GR24312	549,00	GR24412	639,00	GR24512	729,00
1830	1830	1802	GR24313	569,00	GR24413	659,00	GR24513	759,00
1880	1880	1852	GR24314	579,00	GR24414	689,00	GR24514	789,00
1950	1950	1922	GR24315	579,00	GR24415	679,00	GR24515	779,00
2000	2000	1972	GR24316	599,00	GR24416	699,00	GR24516	819,00
2070	2070	2042	GR24317	589,00	GR24417	699,00	GR24517	799,00
2120	2120	2092	GR24318	599,00	GR24418	719,00	GR24518	829,00
2190	2190	2162	GR24319	599,00	GR24419	719,00	GR24519	829,00
2240	2240	2212	GR24320	619,00	GR24420	739,00	GR24520	849,00
2360	2360	2332	GR24321	629,00	GR24421	749,00	GR24521	869,00
2420	2420	2392	GR24322	649,00	GR24422	769,00	GR24522	899,00
2480	2480	2452	GR24323	649,00	GR24423	769,00	GR24523	899,00

Höhe: **2000 mm**
Tiefe: **470 mm**

Anbauregalsystem / Kühlzelle & Lager



- Platzsparend
- leichter & schneller Aufbau
- Kunststoffböden höhenverstellbar & herausnehmbar
- sehr pflegeleicht
- geringes Gewicht
- im 90°-Winkel über Eck

L-Form | Höhe: 2000 mm | Tiefe: 470 mm

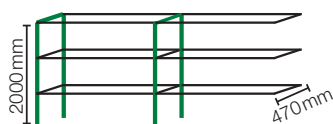
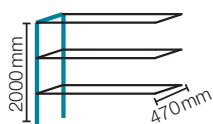

ab 1660 mm Breite Zwei Regalträger

Breite	Außen	Innen	3 Böden		4 Böden		5 Böden	
			Code	Euro	Code	Euro	Code	Euro
650	650	650	AR24301	239,00	AR24401	289,00	AR24501	339,00
770	770	770	AR24302	249,00	AR24402	299,00	AR24502	359,00
890	890	890	AR24303	269,00	AR24403	319,00	AR24503	379,00
940	940	940	AR24304	279,00	AR24404	349,00	AR24504	419,00
1060	1060	1060	AR24305	299,00	AR24405	369,00	AR24505	429,00
1180	1180	1180	AR24306	299,00	AR24406	379,00	AR24506	449,00
1300	1300	1300	AR24307	319,00	AR24407	399,00	AR24507	479,00
1480	1480	1480	AR24308	349,00	AR24408	439,00	AR24508	519,00
1600	1600	1600	AR24309	359,00	AR24409	449,00	AR24509	539,00
1660	1660	1632	AR24310	479,00	AR24410	579,00	AR24510	679,00
1710	1710	1682	AR24311	499,00	AR24411	599,00	AR24511	719,00
1780	1780	1752	AR24312	489,00	AR24412	599,00	AR24512	699,00
1830	1830	1802	AR24313	519,00	AR24413	619,00	AR24513	729,00
1880	1880	1852	AR24314	529,00	AR24414	649,00	AR24514	759,00
1950	1950	1922	AR24315	519,00	AR24415	639,00	AR24515	749,00
2000	2000	1972	AR24316	539,00	AR24416	659,00	AR24516	779,00
2070	2070	2042	AR24317	539,00	AR24417	659,00	AR24517	769,00
2120	2120	2092	AR24318	559,00	AR24418	679,00	AR24518	799,00
2190	2190	2162	AR24319	549,00	AR24419	679,00	AR24519	799,00
2240	2240	2212	AR24320	569,00	AR24420	699,00	AR24520	899,00
2360	2360	2332	AR24321	579,00	AR24421	719,00	AR24521	849,00
2420	2420	2392	AR24322	599,00	AR24422	729,00	AR24522	869,00
2480	2480	2452	AR24323	599,00	AR24423	729,00	AR24523	869,00

Höhe: 1750 mm Tiefe: 385 mm 2/3 GN-Grundregalsystem / Kühlzelle & Lager



Höhe: 1750 mm | Tiefe: 385 mm



**GN
2/3**

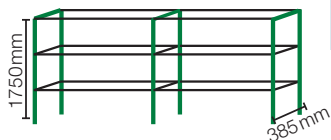
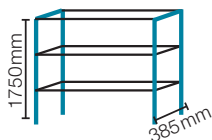

Traglast (Boden):
kg
< 1 m = 120 kg
> 1 m = 100 kg

ab 1660 mm Breite **DREI** Regalträger

SET	GN p. Boden	Breite	Innen	3 Böden		4 Böden		5 Böden	
				Code	Euro	Code	Euro	Code	Euro
	2	710	710	GN13301	259,00	GN13401	289,00	GN13501	329,00
	2	820	820	GN13302	269,00	GN13402	299,00	GN13502	349,00
	2	930	930	GN13303	279,00	GN13403	319,00	GN13503	369,00
	3	1035	1035	GN13304	299,00	GN13404	349,00	GN13504	399,00
	3	1145	1145	GN13305	319,00	GN13405	359,00	GN13505	419,00
	3	1255	1255	GN13306	319,00	GN13406	379,00	GN13506	439,00
	3	1365	1365	GN13307	339,00	GN13407	399,00	GN13507	459,00
	4	1470	1470	GN13308	359,00	GN13408	429,00	GN13508	499,00
	4	1580	1580	GN13309	369,00	GN13409	439,00	GN13509	519,00
	2+2	1640	1612	GN13310	459,00	GN13410	539,00	GN13510	619,00
	2+2	1750	1722	GN13311	469,00	GN13411	559,00	GN13511	639,00
	3+2	1855	1827	GN13312	489,00	GN13412	579,00	GN13512	669,00
	2+3	1965	1937	GN13313	499,00	GN13413	599,00	GN13513	689,00
	3+3	2070	2042	GN13314	519,00	GN13414	619,00	GN13514	719,00
	3+3	2180	2152	GN13315	529,00	GN13415	639,00	GN13515	739,00
	3+3	2290	2262	GN13316	549,00	GN13416	649,00	GN13516	759,00
	2+4	2400	2372	GN13317	559,00	GN13417	669,00	GN13517	789,00
	3+4	2505	2477	GN13318	579,00	GN13418	699,00	GN13518	819,00
	3+4	2615	2587	GN13319	589,00	GN13419	719,00	GN13519	839,00
	3+4	2725	2697	GN13320	599,00	GN13420	729,00	GN13520	859,00
	3+4	2835	2807	GN13321	619,00	GN13421	749,00	GN13521	879,00
	4+4	2940	2912	GN13322	639,00	GN13422	779,00	GN13522	919,00
	4+4	3050	3022	GN13323	649,00	GN13423	789,00	GN13523	939,00

Höhe: 1750 mm Tiefe: 385 mm 2/3 GN-Anbauregalsystem / Kühlzelle & Lager



L-Form | Höhe: 1750 mm | Tiefe: 385 mm

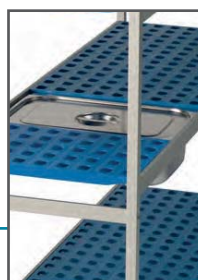

GN
2/3

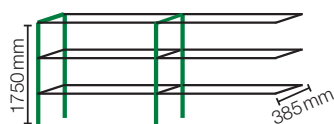
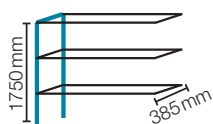

ab 1660 mm Breite Zwei Regalträger

SET	GN p. Boden	Breite	Innen	3 Böden		4 Böden		5 Böden	
				Code	Euro	Code	Euro	Code	Euro
	2	710	710	GA13301	219,00	GA13401	259,00	GA13501	299,00
	2	820	820	GA13302	229,00	GA13402	279,00	GA13502	329,00
	2	930	930	GA13303	239,00	GA13403	289,00	GA13503	349,00
	3	1035	1035	GA13304	259,00	GA13404	319,00	GA13504	
	3	1145	1145	GA13305	269,00	GA13405	329,00	GA13505	399,00
	3	1255	1255	GA13306	279,00	GA13406	349,00	GA13506	419,00
	3	1365	1365	GA13307	289,00	GA13407	369,00	GA13507	439,00
	4	1470	1470	GA13308	319,00	GA13408	399,00	GA13508	479,00
	4	1580	1580	GA13309	329,00	GA13409	419,00	GA13509	499,00
	2+2	1640	1612	GA13310	419,00	GA13410	499,00	GA13510	599,00
	2+2	1750	1722	GA13311	429,00	GA13411	529,00	GA13511	619,00
	3+2	1855	1827	GA13312	449,00	GA13412	549,00	GA13512	649,00
	2+3	1965	1937	GA13313	459,00	GA13413	569,00	GA13513	669,00
	3+3	2070	2042	GA13314	479,00	GA13414	589,00	GA13514	699,00
	3+3	2180	2152	GA13315	489,00	GA13415	599,00	GA13515	719,00
	3+3	2290	2262	GA13316	499,00	GA13416	619,00	GA13516	739,00
	2+4	2400	2372	GA13317	519,00	GA13417	639,00	GA13517	769,00
	3+4	2505	2477	GA13318	539,00	GA13418	669,00	GA13518	799,00
	3+4	2615	2587	GA13319	549,00	GA13419	689,00	GA13519	819,00
	3+4	2725	2697	GA13320	559,00	GA13420	699,00	GA13520	839,00
	3+4	2835	2807	GA13321	579,00	GA13421	719,00	GA13521	859,00
	4+4	2940	2912	GA13322	599,00	GA13422	749,00	GA13522	899,00
	4+4	3050	3022	GA13323	619,00	GA13423	759,00	GA13523	919,00

Höhe: **2000 mm**
Tiefe: **385 mm**

2/3 GN-Grundregalsystem / Kühlzelle & Lager



Höhe: 2000 mm | Tiefe: 385 mm



**GN
2/3**

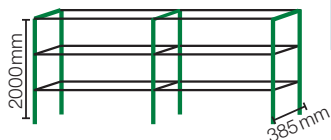
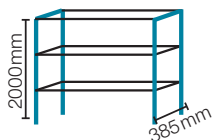

Traglast (Boden):
 $< 1\text{ m} = 120\text{ kg}$
 $> 1\text{ m} = 100\text{ kg}$

ab 1660 mm Breite **DREI** Regalträger

Breite	GN p. Boden	Außen	Innen	3 Böden		4 Böden		5 Böden	
				Code	Euro	Code	Euro	Code	Euro
710	2	710	710	GN23301	279,00	GN23401	319,00	GN23501	349,00
820	2	820	820	GN23302	289,00	GN23402	329,00	GN23502	369,00
930	2	930	930	GN23303	299,00	GN23403	349,00	GN23503	389,00
1035	3	1035	1035	GN23304	329,00	GN23404	369,00	GN23504	419,00
1145	3	1145	1145	GN23305	339,00	GN23405	389,00	GN23505	439,00
1255	3	1255	1255	GN23306	349,00	GN23406	399,00	GN23506	469,00
1365	3	1365	1365	GN23307	359,00	GN23407	419,00	GN23507	489,00
1470	4	1470	1470	GN23308	379,00	GN23408	449,00	GN23508	519,00
1580	4	1580	1580	GN23309	399,00	GN23409	469,00	GN23509	539,00
1640	2+2	1640	1612	GN23310	499,00	GN23410	579,00	GN23510	659,00
1750	2+2	1750	1722	GN23311	519,00	GN23411	599,00	GN23511	679,00
1855	3+2	1855	1827	GN23312	529,00	GN23412	619,00	GN23512	699,00
1965	2+3	1965	1937	GN23313	539,00	GN23413	639,00	GN23513	729,00
2070	3+3	2070	2042	GN23314	559,00	GN23414	659,00	GN23514	759,00
2180	3+3	2180	2152	GN13315	569,00	GN23415	679,00	GN23515	779,00
2290	3+3	2290	2262	GN23316	589,00	GN23416	689,00	GN23516	799,00
2400	2+4	2400	2372	GN23317	599,00	GN23417	719,00	GN23517	829,00
2505	3+4	2505	2477	GN23318	619,00	GN23418	739,00	GN23518	859,00
2615	3+4	2615	2587	GN23319	629,00	GN23419	759,00	GN23519	879,00
2725	3+4	2725	2697	GN23320	649,00	GN23420	769,00	GN23520	899,00
2835	3+4	2835	2807	GN23321	659,00	GN23421	789,00	GN23521	919,00
2940	4+4	2940	2912	GN23322	679,00	GN23422	819,00	GN23522	959,00
3050	4+4	3050	3022	GN23323	689,00	GN23423	829,00	GN23523	979,00

Höhe: **2000 mm**
Tiefe: **385 mm**

2/3 GN-Anbauregalsystem / Kühlzelle & Lager



L-Form | Höhe: 2000 mm | Tiefe: 385 mm

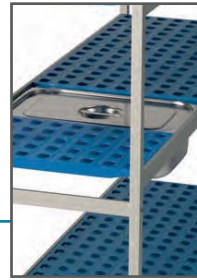

**GN
2/3**

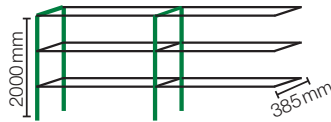
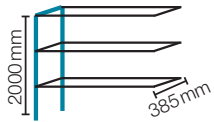

ab 1660 mm Breite Zwei Regalträger

Breite	GN p. Boden	Außen	Innen	3 Böden		4 Böden		5 Böden	
				Code	Euro	Code	Euro	Code	Euro
710	2	710	710	GA23301	229,00	GA23401	269,00	GA23501	319,00
820	2	820	820	GA23302	239,00	GA23402	289,00	GA23502	339,00
930	2	930	930	GA23303	249,00	GA23403	299,00	GA23503	359,00
1035	3	1035	1035	GA23304	269,00	GA23404	329,00	GA23504	389,00
1145	3	1145	1145	GA23305	279,00	GA23405	349,00	GA23505	419,00
1255	3	1255	1255	GA23306	299,00	GA23406	359,00	GA23506	429,00
1365	3	1365	1365	GA23307	299,00	GA23407	379,00	GA23507	449,00
1470	4	1470	1470	GA23308	329,00	GA23408	399,00	GA23508	489,00
1580	4	1580	1580	GA23309	339,00	GA23409	429,00	GA23509	519,00
1640	2+2	1640	1612	GA23310	449,00	GA23410	539,00	GA23510	629,00
1750	2+2	1750	1722	GA23311	459,00	GA23411	549,00	GA23511	649,00
1855	3+2	1855	1827	GA23312	479,00	GA23412	579,00	GA23512	679,00
1965	2+3	1965	1937	GA23313	489,00	GA23413	589,00	GA23513	699,00
2070	3+3	2070	2042	GA23314	499,00	GA23414	619,00	GA23514	729,00
2180	3+3	2180	2152	GA23315	519,00	GA23415	629,00	GA23515	749,00
2290	3+3	2290	2262	GA23316	529,00	GA23416	649,00	GA23516	769,00
2400	2+4	2400	2372	GA23317	549,00	GA23417	669,00	GA23517	799,00
2505	3+4	2505	2477	GA23318	569,00	GA23418	699,00	GA23518	829,00
2615	3+4	2615	2587	GA23319	579,00	GA23419	719,00	GA23519	849,00
2725	3+4	2725	2697	GA23320	589,00	GA23420	729,00	GA23520	869,00
2835	3+4	2835	2807	GA23321	599,00	GA23421	749,00	GA23521	889,00
2940	4+4	2940	2912	GA23322	629,00	GA23422	769,00	GA23522	919,00
3050	4+4	3050	3022	GA23323	639,00	GA23423	789,00	GA23523	939,00

Höhe: **1750 mm**
Tiefe: **560 mm**

1/1 GN-Grundregalsystem / Kühlzelle & Lager



Höhe: **1750 mm** | Tiefe: **560 mm**



**GN
1/1**

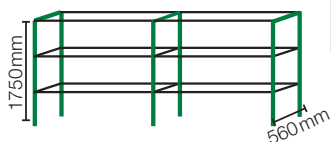
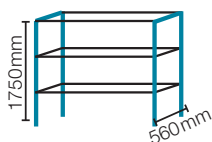

Traglast (Boden):
kg
< 1 m = **120 kg**
> 1 m = **100 kg**

ab 1660 mm Breite **DREI** Regalträger

Breite	GN p. Boden	Außen	Innen	3 Böden		4 Böden		5 Böden	
				Code	Euro	Code	Euro	Code	Euro
710	2	710	710	GN15301	279,00	GN15401	319,00	GN15501	359,00
820	2	820	820	GN15302	299,00	GN15402	339,00	GN15502	389,00
930	2	930	930	GN15303	319,00	GN15403	359,00	GN15503	419,00
1035	3	1035	1035	GN15304	329,00	GN15404	389,00	GN15504	449,00
1145	3	1145	1145	GN15305	349,00	GN15405	399,00	GN15505	469,00
1255	3	1255	1255	GN15306	359,00	GN15406	429,00	GN15506	489,00
1365	3	1365	1365	GN15307	369,00	GN15407	449,00	GN15507	519,00
1470	4	1470	1470	GN15308	399,00	GN15408	479,00	GN15508	559,00
1580	4	1580	1580	GN15309	419,00	GN15409	499,00	GN15509	589,00
1640	2+2	1640	1612	GN15310	519,00	GN15410	599,00	GN15510	699,00
1750	2+2	1750	1722	GN15311	529,00	GN15411	629,00	GN15511	719,00
1855	3+2	1855	1827	GN15312	549,00	GN15412	649,00	GN15512	759,00
1965	2+3	1965	1937	GN15313	559,00	GN15413	669,00	GN15513	779,00
2070	3+3	2070	2042	GN15314	579,00	GN15414	699,00	GN15514	819,00
2180	3+3	2180	2152	GN15315	599,00	GN15415	719,00	GN15515	839,00
2290	3+3	2290	2262	GN15316	619,00	GN15416	739,00	GN15516	869,00
2400	2+4	2400	2372	GN15317	629,00	GN15417	759,00	GN15517	889,00
2505	3+4	2505	2477	GN15318	649,00	GN15418	789,00	GN15518	929,00
2615	3+4	2615	2587	GN15319	669,00	GN15419	819,00	GN15519	949,00
2725	3+4	2725	2697	GN15320	679,00	GN15420	829,00	GN15520	969,00
2835	3+4	2835	2807	GN15321	699,00	GN15421	849,00	GN15521	999,00
2940	4+4	2940	2912	GN15322	719,00	GN15422	879,00	GN15522	1.039,00
3050	4+4	3050	3022	GN15323	739,00	GN15423	899,00	GN15523	1.069,00

Höhe: **1750 mm**
Tiefe: **560 mm**

1/1 GN-Anbauregalsystem / Kühlzelle & Lager



L-Form | Höhe: **1750 mm** | Tiefe: **560 mm**

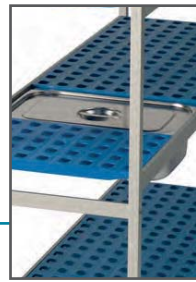

**GN
1/1**

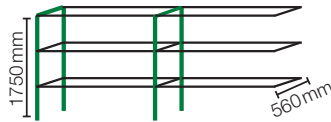
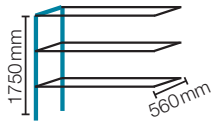

ab 1660 mm Breite **Zwei Regalträger**

Breite	GN p. Boden	Außen	Innen	3 Böden		4 Böden		5 Böden	
				Code	Euro	Code	Euro	Code	Euro
710	2	710	710	GA15301	249,00	GA15401	299,00	GA15501	357,41
820	2	820	820	GA15302	259,00	GA15402	319,00	GA15502	379,00
930	2	930	930	GA15303	269,00	GA15403	339,00	GA15503	399,00
1035	3	1035	1035	GA15304	299,00	GA15404	369,00	GA15504	439,00
1145	3	1145	1145	GA15305	319,00	GA15405	389,00	GA15505	469,00
1255	3	1255	1255	GA15306	319,00	GA15406	399,00	GA15506	489,00
1365	3	1365	1365	GA15307	339,00	GA15407	429,00	GA15507	519,00
1470	4	1470	1470	GA15308	359,00	GA15408	459,00	GA15508	549,00
1580	4	1580	1580	GA15309	379,00	GA15409	479,00	GA15509	579,00
1640	2+2	1640	1612	GA15310	479,00	GA15410	579,00	GA15510	689,00
1750	2+2	1750	1722	GA15311	489,00	GA15411	599,00	GA15511	719,00
1855	3+2	1855	1827	GA15312	519,00	GA15412	629,00	GA15512	749,00
1965	2+3	1965	1937	GA15313	529,00	GA15413	649,00	GA15513	769,00
2070	3+3	2070	2042	GA15314	549,00	GA15414	679,00	GA15514	799,00
2180	3+3	2180	2152	GA15315	559,00	GA15415	699,00	GA15515	829,00
2290	3+3	2290	2262	GA15316	579,00	GA15416	719,00	GA15516	859,00
2400	2+4	2400	2372	GA15317	589,00	GA15417	739,00	GA15517	879,00
2505	3+4	2505	2477	GA15318	619,00	GA15418	769,00	GA15518	919,00
2615	3+4	2615	2587	GA15319	629,00	GA15419	789,00	GA15519	949,00
2725	3+4	2725	2697	GA15320	639,00	GA15420	799,00	GA15520	969,00
2835	3+4	2835	2807	GA15321	659,00	GA15421	829,00	GA15521	999,00
2940	4+4	2940	2912	GA15322	679,00	GA15422	859,00	GA15522	1.029,00
3050	4+4	3050	3022	GA15323	699,00	GA15423	879,00	GA15523	1.069,00

Höhe: **2000 mm**
Tiefe: **560 mm**

1/1 GN-Grundregalsystem / Kühlzelle & Lager



Höhe: 2000 mm | Tiefe: 560 mm



**GN
1/1**

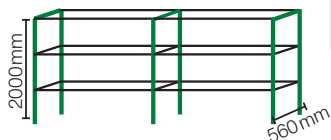
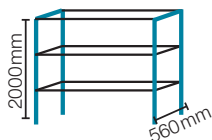

Traglast (Boden):
 < 1 m = **120 kg**
 > 1 m = **100 kg**

ab 1660 mm Breite **DREI** Regalträger

Breite	GN p. Boden	Außen	Innen	3 Böden		4 Böden		5 Böden	
				Code	Euro	Code	Euro	Code	Euro
710	2	710	710	GN25301	319,00	GN25401	349,00	GN25501	389,00
820	2	820	820	GN25302	329,00	GN25402	369,00	GN25502	419,00
930	2	930	930	GN25303	339,00	GN25403	389,00	GN25503	439,00
1035	3	1035	1035	GN25304	359,00	GN25404	419,00	GN25504	479,00
1145	3	1145	1145	GN25305	379,00	GN25405	439,00	GN25505	499,00
1255	3	1255	1255	GN25306	389,00	GN25406	459,00	GN25506	519,00
1365	3	1365	1365	GN25307	399,00	GN25407	479,00	GN25507	549,00
1470	4	1470	1470	GN25308	429,00	GN25408	499,00	GN25508	589,00
1580	4	1580	1580	GN25309	449,00	GN25409	529,00	GN25509	619,00
1640	2+2	1640	1612	GN25310	559,00	GN25410	649,00	GN25510	739,00
1750	2+2	1750	1722	GN25311	569,00	GN25411	669,00	GN25511	769,00
1855	3+2	1855	1827	GN25312	589,00	GN25412	699,00	GN25512	799,00
1965	2+3	1965	1937	GN25313	599,00	GN25413	719,00	GN25513	819,00
2070	3+3	2070	2042	GN25314	629,00	GN25414	739,00	GN25514	859,00
2180	3+3	2180	2152	GN25315	639,00	GN25415	759,00	GN25515	879,00
2290	3+3	2290	2262	GN25316	659,00	GN25416	779,00	GN25516	899,00
2400	2+4	2400	2372	GN25317	669,00	GN25417	799,00	GN25517	939,00
2505	3+4	2505	2477	GN25318	699,00	GN25418	829,00	GN25518	969,00
2615	3+4	2615	2587	GN25319	719,00	GN25419	849,00	GN25519	999,00
2725	3+4	2725	2697	GN25320	719,00	GN25420	869,00	GN25520	1019,00
2835	3+4	2835	2807	GN25321	739,00	GN25421	899,00	GN25521	1.049,00
2940	4+4	2940	2912	GN25322	759,00	GN25422	919,00	GN25522	1.079,00
3050	4+4	3050	3022	GN25323	779,00	GN25423	949,00	GN25523	1.119,00

Höhe: **2000 mm**
Tiefe: **560 mm**

1/1 GN-Anbauregalsystem / Kühlzelle & Lager



L-Form | Höhe: 2000 mm | Tiefe: 560 mm

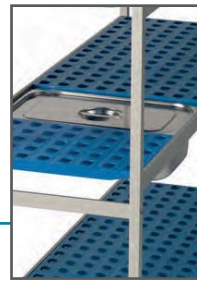

**GN
1/1**

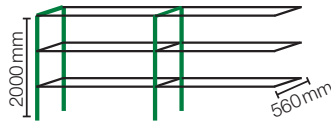
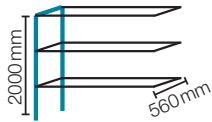

ab 1660 mm Breite Zwei Regalträger

Breite	GN p. Boden	Außen	Innen	3 Böden		4 Böden		5 Böden	
				Code	Euro	Code	Euro	Code	Euro
710	2	710	710	GA25301	259,00	GA25401	319,00	GA25501	919,00
820	2	820	820	GA25302	279,00	GA25402	339,00	GA25502	919,00
930	2	930	930	GA25303	289,00	GA25403	349,00	GA25503	919,00
1035	3	1035	1035	GA25304	319,00	GA25404	379,00	GA25504	919,00
1145	3	1145	1145	GA25305	329,00	GA25405	399,00	GA25505	919,00
1255	3	1255	1255	GA25306	339,00	GA25406	419,00	GA25506	919,00
1365	3	1365	1365	GA25307	349,00	GA25407	439,00	GA25507	919,00
1470	4	1470	1470	GA25308	379,00	GA25408	469,00	GA25508	919,00
1580	4	1580	1580	GA25309	399,00	GA25409	499,00	GA25509	919,00
1640	2+2	1640	1612	GA25310	499,00	GA25410	619,00	GA25510	919,00
1750	2+2	1750	1722	GA25311	519,00	GA25411	629,00	GA25511	919,00
1855	3+2	1855	1827	GA25312	539,00	GA25412	659,00	GA25512	919,00
1965	2+3	1965	1937	GA25313	559,00	GA25413	679,00	GA25513	919,00
2070	3+3	2070	2042	GA25314	579,00	GA25414	699,00	GA25514	919,00
2180	3+3	2180	2152	GA25315	589,00	GA25415	729,00	GA25515	919,00
2290	3+3	2290	2262	GA25316	599,00	GA25416	749,00	GA25516	919,00
2400	2+4	2400	2372	GA25317	619,00	GA25417	769,00	GA25517	919,00
2505	3+4	2505	2477	GA25318	639,00	GA25418	799,00	GA25518	919,00
2615	3+4	2615	2587	GA25319	659,00	GA25419	819,00	GA25519	919,00
2725	3+4	2725	2697	GA25320	669,00	GA25420	829,00	GA25520	919,00
2835	3+4	2835	2807	GA25321	689,00	GA25421	859,00	GA25521	919,00
2940	4+4	2940	2912	GA25322	719,00	GA25422	889,00	GA25522	919,00
3050	4+4	3050	3022	GA25323	729,00	GA25423	919,00	GA25523	919,00